

# HP 83205A CDMA Cellular Adapter

## *User's Guide*

HP 8921A Firmware Version A.16.00 & Above

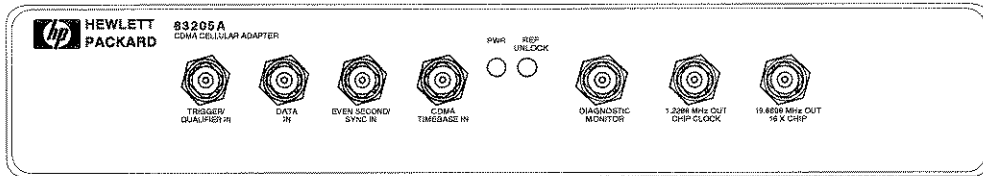

**HP Part No. 83205-90008**  
**Printed in U. S. A.**  
**August 1996**

**Rev. B**

Copyright © Hewlett-Packard Company 1996

**Notice**

Information contained in this document is subject to change without notice.

All Rights Reserved. Reproduction, adaptation, or translation without prior written permission is prohibited, except as allowed under the copyright laws.

This material may be reproduced by or for the U.S. Government pursuant to the Copyright License under the clause at DFARS 52.227-7013 (APR 1988).

Hewlett-Packard Company  
Learning Products Department  
24001 E. Mission  
Liberty Lake, WA 99019-9599  
U.S.A.

## **Manufacturer's Declaration**

This statement is provided to comply with the requirements of the German Sound Emission Directive, from 18 January 1991. This product has a sound pressure emission (at the operator position) < 70 dB(A).

- Sound Pressure  $L_p < 70$  dB(A).
- At Operator Position.
- Normal Operation.
- According to ISO 7779:1988/EN 27779:1991 (Type Test).

## **Herstellerbescheinigung**

Diese Information steht im Zusammenhang mit den Anforderungen der Maschinenlärminformationsverordnung vom 18 Januar 1991.

- Schalldruckpegel  $L_p < 70$  dB(A).
- Am Arbeitsplatz.
- Normaler Betrieb.
- Nach ISO 7779:1988/EN 27779:1991 (Typprüfung).

## Safety Considerations

### GENERAL

This product and related documentation must be reviewed for familiarization with safety markings and instructions before operation.

This product is a Safety Class I instrument (provided with a protective earth terminal).

### SAFETY EARTH GROUND

A uninterruptible safety earth ground must be provided from the main power source to the product input wiring terminals, power cord, or supplied power cord set.

### CHASSIS GROUND TERMINAL

To prevent a potential shock hazard, always connect the rear-panel chassis ground terminal to earth ground when operating this instrument from a dc power source.

### SAFETY SYMBOLS



Indicates instrument damage can occur if indicated operating limits are exceeded.



Indicates hazardous voltages.



Indicates earth (ground) terminal

This product contains batteries.  
When batteries are replaced, dispose  
of defunct batteries through proper  
channels.



---

### **WARNING**

A **WARNING** note denotes a hazard. It calls attention to a procedure, practice, or the like, which, if not correctly performed or adhered to, could result in personal injury. Do not proceed beyond a **WARNING** sign until the indicated conditions are fully understood and met.

---

### **CAUTION**

A **CAUTION** note denotes a hazard. It calls attention to an operation procedure, practice, or the like, which, if not correctly performed or adhered to, could result in damage to or destruction of part or all of the product. Do not proceed beyond an **CAUTION** note until the indicated conditions are fully understood and met.

## Safety Considerations for this Instrument

---

**WARNING:**

This product is a Safety Class 1 instrument (provided with a protective earthing ground incorporated in the power cord) The mains plug shall only be inserted in a socket outlet provided with a protective earth contact. Any interruption of the protective conductor inside or outside of the product is likely to make the product dangerous. Intentional interruption is prohibited.

Whenever it is likely that the protection has been impaired, the instrument must be made inoperative and be secured against any unintended operation.

If this instrument is to be energized via an autotransformer (for voltage reduction), make sure the common terminal is connected to the earth terminal of the power source.

If this product is not used as specified, the protection provided by the equipment could be impaired. This product must be used in a normal condition (in which all means for protection are intact) only.

No operator serviceable parts in this product. Refer servicing to qualified personnel. To prevent electrical shock, do not remove covers.

Servicing instructions are for use by qualified personnel only. To avoid electrical shock, do not perform any servicing unless you are qualified to do so.

The opening of covers or removal of parts is likely to expose dangerous voltages. Disconnect the product from all voltage sources while it is being opened.

Adjustments described in the manual are performed with power supplied to the instrument while protective covers are removed. Energy available at many points may, if contacted, result in personal injury.

The power cord is connected to internal capacitors that may remain live for 5 seconds after disconnecting the plug from its power supply.

For continued protection against fire hazard, replace the line fuse(s) only with 250 V fuse(s) or the same current rating and type (for example, normal blow or time delay). Do not use repaired fuses or short circuited fuseholders.

---

---

**NOTE:**

Always use the three-prong ac power cord supplied with this product. Failure to ensure adequate earth grounding by not using this cord may cause product damage.

---

**CAUTION:**

This product is designed for use in Installation Category II and Pollution Degree 2 per *IEC 1010* and *IEC 664* respectively.

This product has autoranging line voltage input, be sure the supply voltage is within the specified range.

Ventilation Requirements: When installing the product in a cabinet, the convection into and out of the product must not be restricted. The ambient temperature (outside the cabinet) must be less than the maximum operating temperature of the product by 4° C for every 100 watts dissipated in the cabinet. If the total power dissipated in the cabinet is greater than 800 watts, then forced convection must be used.

**Product Markings**

CE - the CE mark is a registered trademark of the European Community. A CE mark accompanied by a year indicated the year the design was proven.

CSA - the CSA mark is a registered trademark of the Canadian Standards Association.

---

**WARNING**

To prevent electrical shock, disconnect the HP 83205A from mains before cleaning. Use a dry cloth or one slightly dampened with water to clean the external case parts. Do not attempt to clean internally.

**CERTIFICATION** *Hewlett-Packard Company certifies that this product met its published specifications at the time of shipment from the factory. Hewlett-Packard further certifies that its calibration measurements are traceable to the United States National Institute of Standards and Technology, to the extent allowed by the Institute's calibration facility, and to the calibration facilities of other International Standards Organization members*

**WARRANTY** This Hewlett-Packard instrument product is warranted against defects in material and workmanship for a period of one year from date of shipment. During the warranty period, Hewlett-Packard Company will at its option, either repair or replace products which prove to be defective.

For warranty service or repair, this product must be returned to a service facility designated by HP. Buyer shall prepay shipping charges to HP and HP shall pay shipping charges, duties, and taxes for products returned to HP from another country.

HP warrants that its software and firmware designated by HP for use with an instrument will execute its programming instructions when properly installed on that instrument. HP does not warrant that the operation of the instrument, or software, or firmware will be uninterrupted or error free.

**LIMITATION OF WARRANTY** The foregoing warranty shall not apply to defects resulting from improper or inadequate maintenance by Buyer, Buyer-supplied software or interfacing, unauthorized modification or misuse, operation outside of the environmental specifications for the product, or improper site preparation or maintenance.

**NO OTHER WARRANTY IS EXPRESSED OR IMPLIED. HP SPECIFICALLY DISCLAIMS THE IMPLIED WARRANTIES OF MERCHANTABILITY AND FITNESS FOR A PARTICULAR PURPOSE.**

**EXCLUSIVE REMEDIES** THE REMEDIES PROVIDED HEREIN ARE BUYER'S SOLE AND EXCLUSIVE REMEDIES. HP SHALL NOT BE LIABLE FOR ANY DIRECT, INDIRECT, SPECIAL, INCIDENTAL, OR CONSEQUENTIAL DAMAGES, WHETHER BASED ON CONTRACT, TORT, OR ANY OTHER LEGAL THEORY.

**ASSISTANCE** *Product maintenance agreements and other customer assistance agreements are available for Hewlett-Packard products. For any assistance, contact your nearest Hewlett-Packard Sales and Service Office.*

## **In this Book**

Chapter 1, Get Started with a Simple CDMA Test, describes how to make an RF loopback test.

Chapter 2, Making CDMA Measurements, describes how to make rho, EVM, channel power, receiver tests, and average power measurements.

Chapter 3, Troubleshooting Measurement Problems, describes common problems encountered while making measurements with the Cellular Adapter and how to recover from those problems.

Chapter 4, CDMA Screens Description, contains reference information for the CDMA Test screens and their fields. .

Chapter 5, Connectors, Indicators, and Misc. Hardware, describes the purpose and use of each connector on the Cellular Adapter. It also provides information about the various indicators (such as the POWER indicator) and hardware parts (such as fuses).

Chapter 6, CDMA Dual Mode Cellular Test HP-IB, provides syntax diagrams for the CDMA Transmitter Tester's functions. It also provides sample programs for some simple tests. For general HP-IB operating information, program examples, and the complete Test Set HP-IB syntax list, refer the Test Set's documentation.

Chapter 7, Theory of Operation, provides theory of operation, a block diagram, and timing diagrams for the operation of the CDMA Cellular Adapter.

Chapter 8, CDMA Basics, provides an overview of CDMA theory as it applies to the Cellular Adapter.

Chapter 9, Questions and Answers, provides information about the basic concepts of CDMA in question and answer form.

Chapter 10, Installation, provides a procedure for re-cabling your CDMA Cellular Adapter if you remove the adapter from the Test Set for repairs or other reasons.

Glossary is a list of common CDMA terms and their definitions.



## Conventions Used in this Manual

- The term Test Set is used to describe the HP 8921A Cell Site Test Set.
- The term Cellular Adapter is used to describe the HP 83205A CDMA Cellular Adapter.
- Names of fields displayed on the Test Set's screens are shown in "computer" font, for example, **Ref Level**.

## General Information About the Test Set

Refer to the Test Set's documentation set for information about any of the following:

- Power and fuse connections for the Test Set, HP-IB address setting and various instrument configuration settings that affect the general operation of the instrument.
- HP customer support, instrument upgrades, and accessories for your Test Set.
- The use of memory cards and other types of mass storage for storing and retrieving IBASIC programs.
- The Test Set's specifications.
- Performance tests used to verify the Test Set's operation.
- Error and operating messages.

## CDPD Operation

This cellular adapter may be configured three different ways:

Option 001 - provides CDMA base station testing.

Option 002 - provides Cellular Digital Packet Data (CDPD) base station testing, and may be retrofitted to also provide CDMA base station testing.

Option 003 - provides testing for both CDMA and CDPD base stations.

CDPD base stations are tested using the Mobile Data Base Station (MDBS) Cell Site Test Software. The software, and its manual, are shipped with every option 002 or option 003 Cellular Adapter. All CDPD testing is done using the software; there is no manual testing. Although a screen titled "CDPD SCREEN" can be accessed, it is only used by the factory software for CDPD testing.



---

## Contents

### 1 Get Started with a Simple CDMA Test

---

## Contents

### **2 Making CDMA Measurements**

Average Power Measurement 30

Channel Power Measurement 38

Waveform Quality (Rho) and Error Vector Magnitude (EVM) Measurements 53

Code Domain Power, Fast Power, Phase, and Timing 60

Performance in Additive Noise (Receiver Test) 72

Receiver Sensitivity 82

---

## Contents

### 3 Troubleshooting Measurement Problems

Verifying the Presence of Your Signal 93

---

## Contents

### **4 CDMA Screens Descriptions**

CDMA Analyzer Screen 100

CDMA Generator Screen 115

Code Domain Analyzer Screen 122

---

## Contents

### **5 Connectors, Indicators, and Miscellaneous Hardware**

Recommended Input Levels 136

Timebase Connections 137

Connectors 138

Indicators 147

Miscellaneous Hardware 148

---

## Contents

### **6 CDMA Dual Mode Cellular Test HP-IB**

Example Programs 150

Data Buffer Operation 153

Status Registers 156

HP-IB Syntax Diagrams 169



---

## Contents

### **7 Theory of Operation**

The Instruments 190

Timing Diagrams 194

DSP Analyzer Trigger Event Timing 197

---

## Contents

### **8 CDMA Basics**

CDMA and the Problem of Access 202

The CDMA Signal 204

CDMA Compared to Analog FM 205

CDMA and Diversity 206

Power Control 209

CDMA Variable Rate Speech Encoder 210

Walsh Codes 211

CDMA Forward Link Physical Layer 212

Long Code Generation 213

Forward Link Channel Format 214

CDMA Reverse Link Physical Layer 216

CDMA Multiplex Sublayer 218

CDMA Transmitter Test 219

CDMA Call Scenario 220

---

## Contents

### **9 Questions and Answers**

CDMA Base Station Transmitter Test 224

CDMA Base Station Receiver Test 229

Summary 231

---

## Contents

### 10 Installation

Installation Procedure 234

---

## Contents

Index 245

---

## Contents

---

## **Get Started with a Simple CDMA Test**

This chapter is provided to help you learn how to use the Test Set by performing an RF loopback test.

This exercise will verify that the CDMA Generator and CDMA Analyzer are operating as they should, and will provide a good way to learn how to navigate through screens and fields. *All controls are assumed to be left in their default (turn-on or PRESET) state unless altered in the procedure.*

**Cable Connections**

- 1** Cable Instrument as shown.  
*Note: Front panel cabling is in addition to the cabling that should have been made during the installation of the Cellular Adapter.*

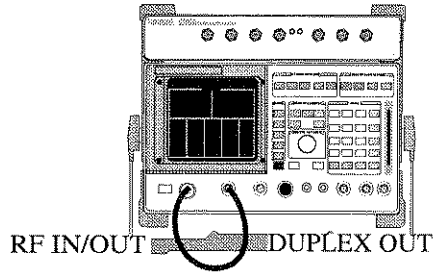

**Front Panel**

- 2** Turn on the Instrument or press preset.



**An Example of How to Make the Setting**

**RX TEST**

- 3** Go to the CDMA GENERATOR screen.

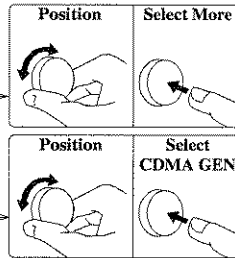
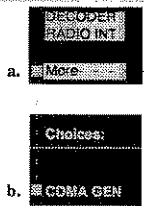

**CDMA GENERATOR**

- 4** Enter an RF frequency of 893.310 MHz.
- 5** Enter an amplitude of -20 dBm.
- 6** Set the CW RF Path to IQ.
- 7** Set the Output Port to Duplex.

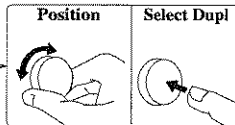
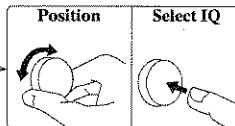
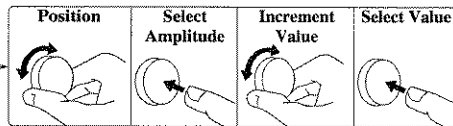
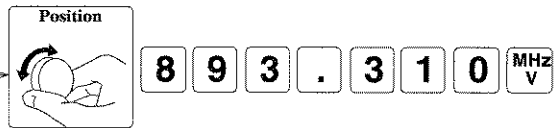

Go To Step 8



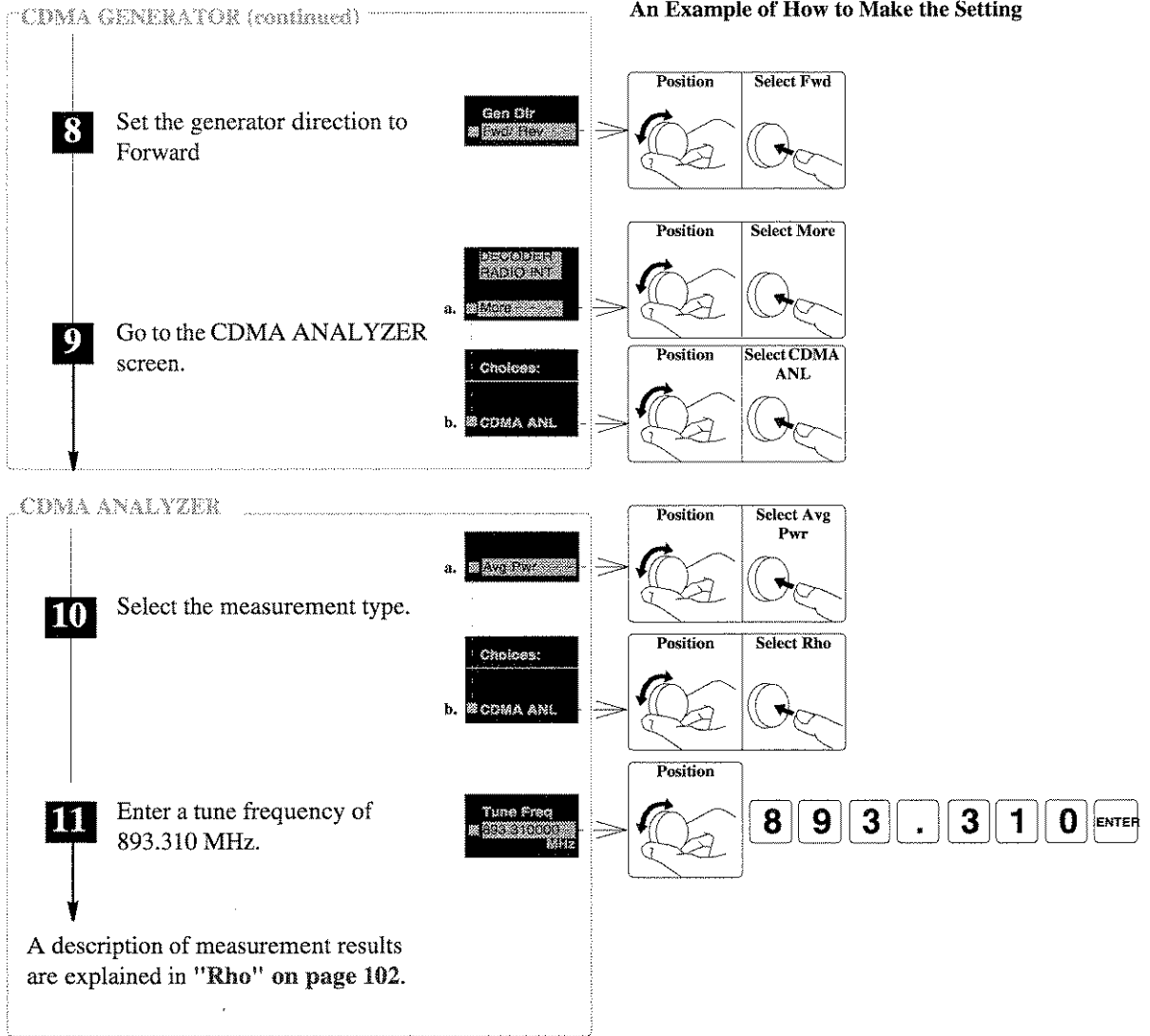



---

## Making CDMA Measurements

The Cellular Adapter provides the following transmitter measurements. For additional descriptions of these measurements, see **chapter 4, "CDMA Screens Descriptions"**

- **Average Power**

Average Power measures the power of the signal present at the RF IN/OUT port. It is a broad-band measurement that measures all the power from about 30 MHz to 1 GHz.

- **ADC FS** (Analog-to-Digital Converter Full Scale) is the relative power level into the CDMA Analyzer, and is displayed when measuring Average Power. This measurement can be used to verify that the correct **Pwr Gain** value is selected.
- **Rho**

Rho is a measure of CDMA waveform quality. The number returned in this measurement indicates how well the measured signal correlates with an ideal reference waveform, with a value of 1 indicating perfect correlation. The CDMA standard specifies 0.912 as the minimum accepted performance for CDMA base stations.

Three additional measurements are displayed when measuring Rho:

- transmitter **time offset** indicates how well your transmitter's signal is time-aligned to system time. The displayed value takes into account the PN Sequence Offset Index of your transmitter that is entered on the CDMA ANALYZER screen.
- carrier **frequency error** is the difference between your transmitter's actual center frequency and the frequency you enter in the **Tune Freq** field.
- **carrier feedthrough** indicates how well the IQ modulator of your transmitter is performing.
- **EVM**

Error Vector Magnitude measures the accuracy of the phase and amplitude of the IQ-modulated signal. It is the RMS magnitude of the vector which connects the ideal signal phasor to a compensated, measured, signal phasor at the detection decision points.

Two related measurements are displayed when measuring EVM:

- **Magnitude Error** is the difference in the RMS magnitude between an ideal signal phasor and the measured phasor.
- **Phase Error** is the RMS value of the difference in phase between an ideal signal phasor and the measured phasor.

- **Channel Power**

Channel power measures the RF power inside a 1.23 MHz bandwidth. This provides rejection of other nearby signals (such as an AMPS transmitter) when measuring the power of a CDMA transmitter.

- **Code Domain Power**

Code Domain Power displays the *relative* power of each of the 64 Walsh Channels being transmitted. Power levels displayed are relative to the total power of the signal in a 1.23 MHz bandwidth.

- Code Domain Timing displays the time offset of each of the 64 Walsh Channels relative to the received Pilot Channel (Walsh channel 0)
- Code Domain Phase displays the phase difference between each of the 64 Walsh Channels relative to the Pilot Channel (Walsh channel 0)
- Fast Power provides faster Code Domain Power measurements. The user enters the measured Time Offset and the number of measurement averages desired. The Code Domain Analyzer then uses those values instead of re-measuring those parameters each time a Code Domain measurement is made.

---

**REAR PANEL  
CABLING**

The rear panel cables between the Test Set and the Cellular Adapter must be connected as described in the installation instructions for the Cellular Adapter; **chapter 10, "Installation"** Any required alterations to these connections are described in the procedures in this chapter.

---

**Selected IS 97 Specifications (Forward Channel)**

- **rho** > 0.912
- **Pilot Time Tolerance** < 10  $\mu$ s (desired, < 3 $\mu$ s.
- **Code Domain Phase** (Off channels) < -27 dB
- **Code Domain Timing** (Pilot to Walsh cover timing tolerance) < 50 ns
- **Code Domain Phase** (Pilot to Walsh cover phase tolerance) < 50 mrad
- **Frequency Error** < 0.05 ppm

## Average Power Measurement

Average Power is an "uncorrelated" measurement; it does not require any external timing signals from the transmitter. The transmitter can be tested in any normal operating condition.

Average Power can only be measured at the Test Set's RF IN/OUT port.

Although the detector is not frequency selective, the measurement assumes that a bandpass signal is applied to the RF IN/OUT port of the Test Set. The detector measures the envelope of the bandpass signal and DSP algorithms convert the envelope information to average power. Calibration factors, based on the analyzer's tune frequency, are applied to average power measurements. The calibration factors only apply to signals centered at the frequency entered in the **Tune Freq** field.

---

### ***UPGRADING OLDER TEST SETS FOR AVERAGE POWER MEASUREMENTS***

To measure Average Power your HP 8921A Test Set must be equipped with a special Input Module. This assembly provides the Detector Output (DET OUT) signal to the Test Set's rear panel. If you have an earlier version of the HP 8921A Test Set that does not have the DET OUT connector on the rear panel, you must return your instrument to the factory for an upgrade to make these measurements. Contact your HP Field Sales Engineer to arrange upgrades.

For details about the steps in the procedure on the following page, see "**Explanation of the Average Power Measurement Procedure**" on page 32.

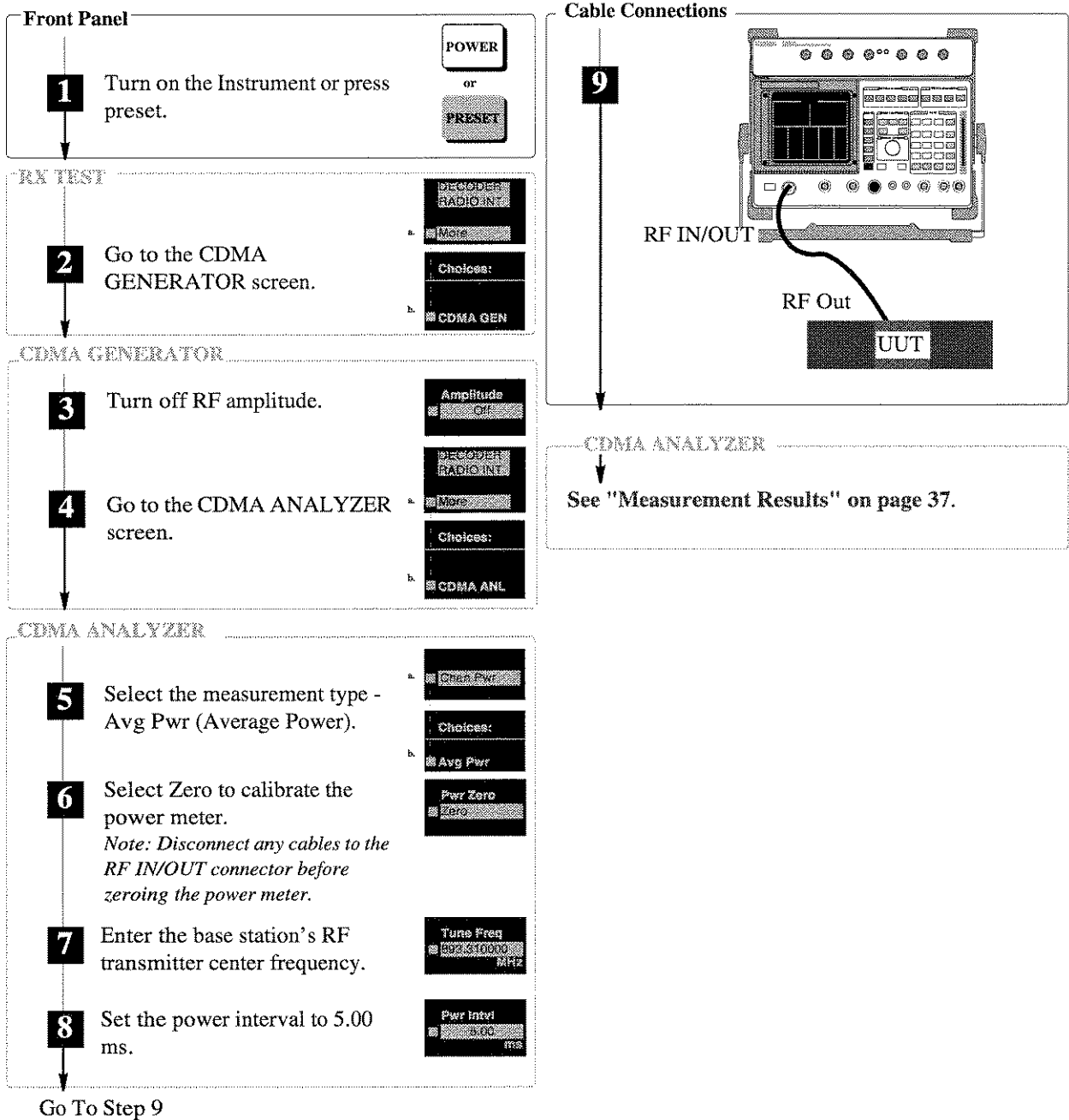

Figure 1 Average Power Measurement Procedure

### Explanation of the Average Power Measurement Procedure

These explanations are intended to add detail about the steps required to perform an average power measurement. For the step by step instruction see "Average Power Measurement Procedure" on page 31.

#### Step 1

This sets the instrument to a known state. The RX TEST screen is displayed when completed.

#### Step 2

Select More and use the knob to scroll through the extended list of screens. Select the CDMA GENERATOR screen to access the RF **Amplitude** field. .

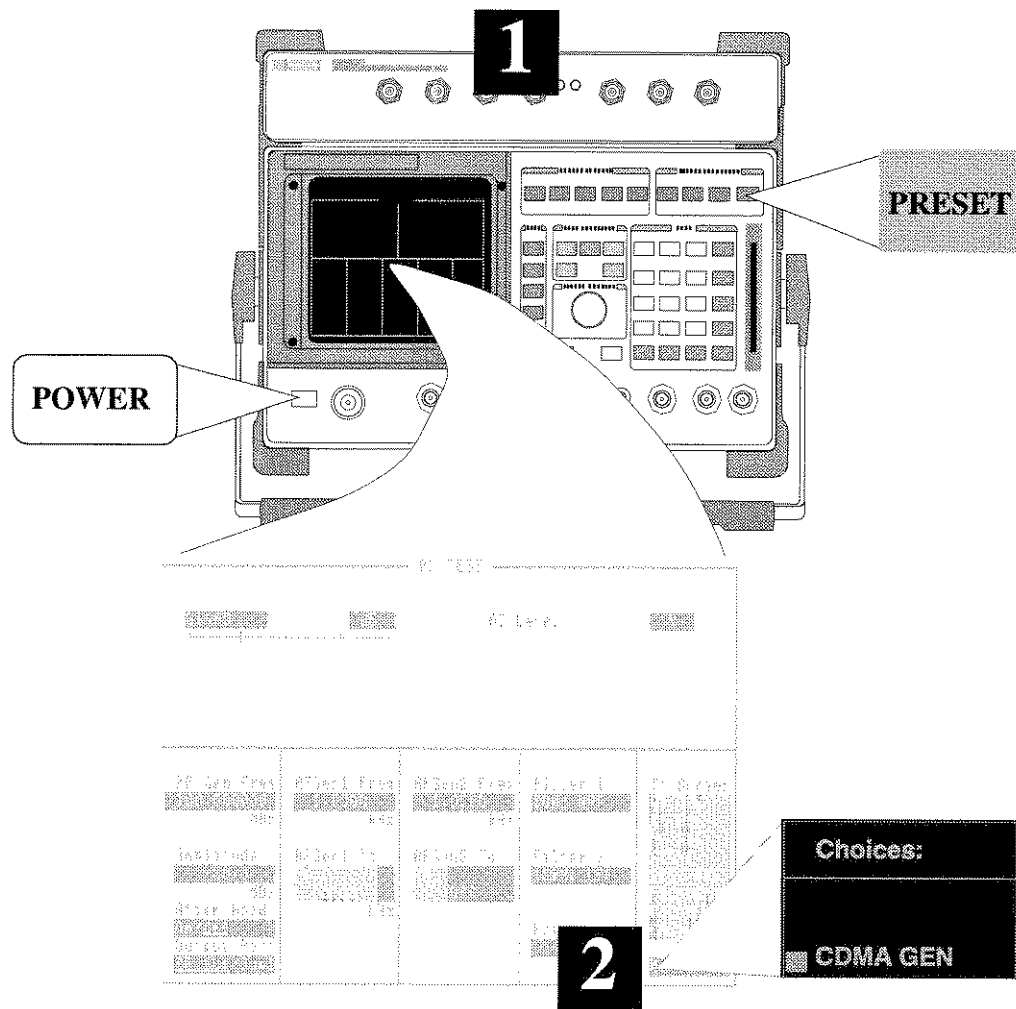



**Step 3** The generator's **Amplitude** is turned Off in preparation for zeroing the power meter. If **Amplitude** is not turned off, power from the generator will cross-couple to the analyzer, and cause the measurement circuitry to zero the average power measurement incorrectly.

**Step 4** Select **More** and turn the CURSOR CONTROL knob. Select the CDMA ANALYZER screen.

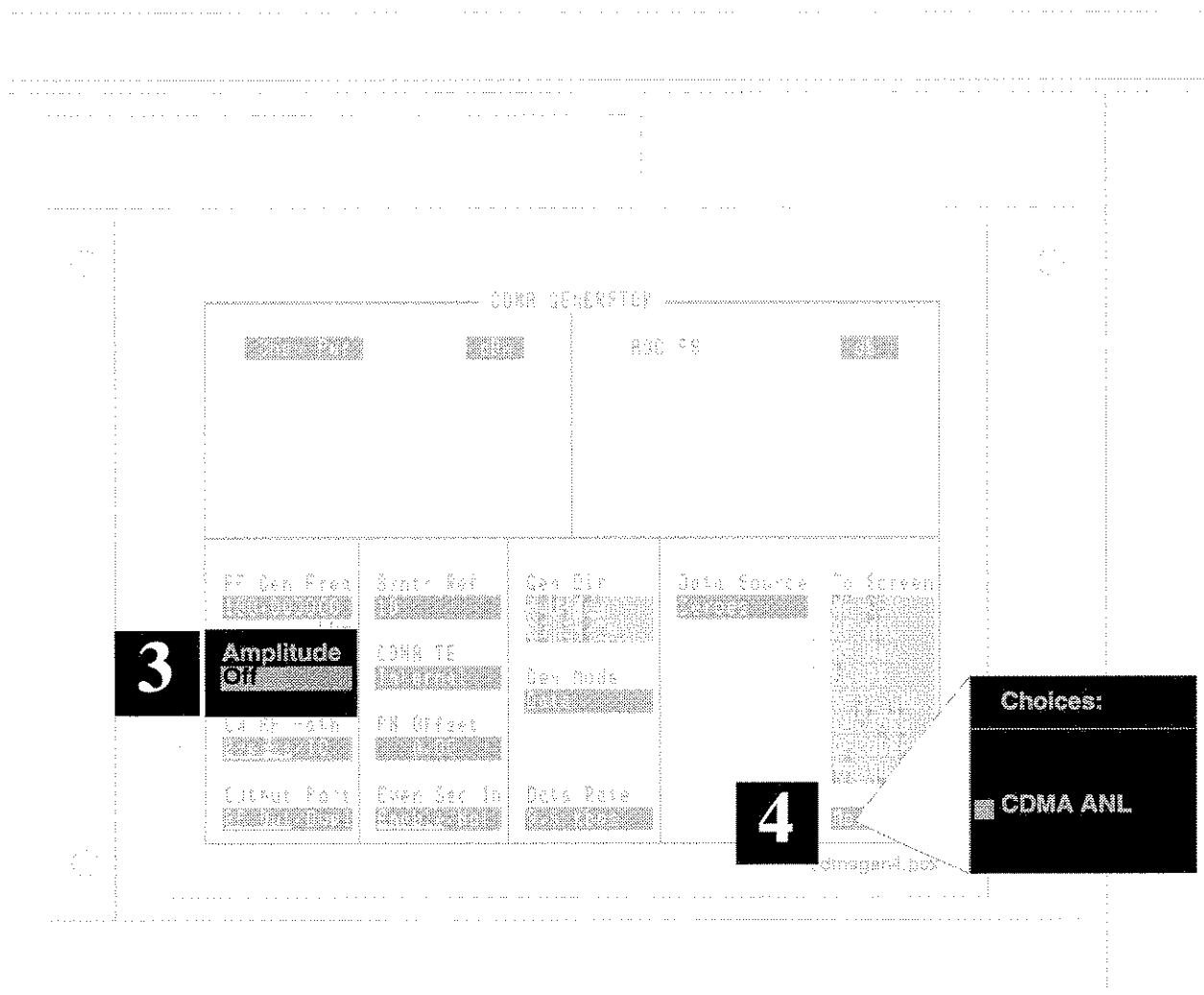

**Step 5** Select the Avg Pwr measurement if it isn't selected already.

**Step 6** The **Pwr Zero** field zeroes the average power meter. When correctly zeroed, the Avg Pwr reading will be a value  $< -20$  dBm or a series of four dashes (----). If the units are changed to Watts or milliwatts the reading will be very close to 0.0000

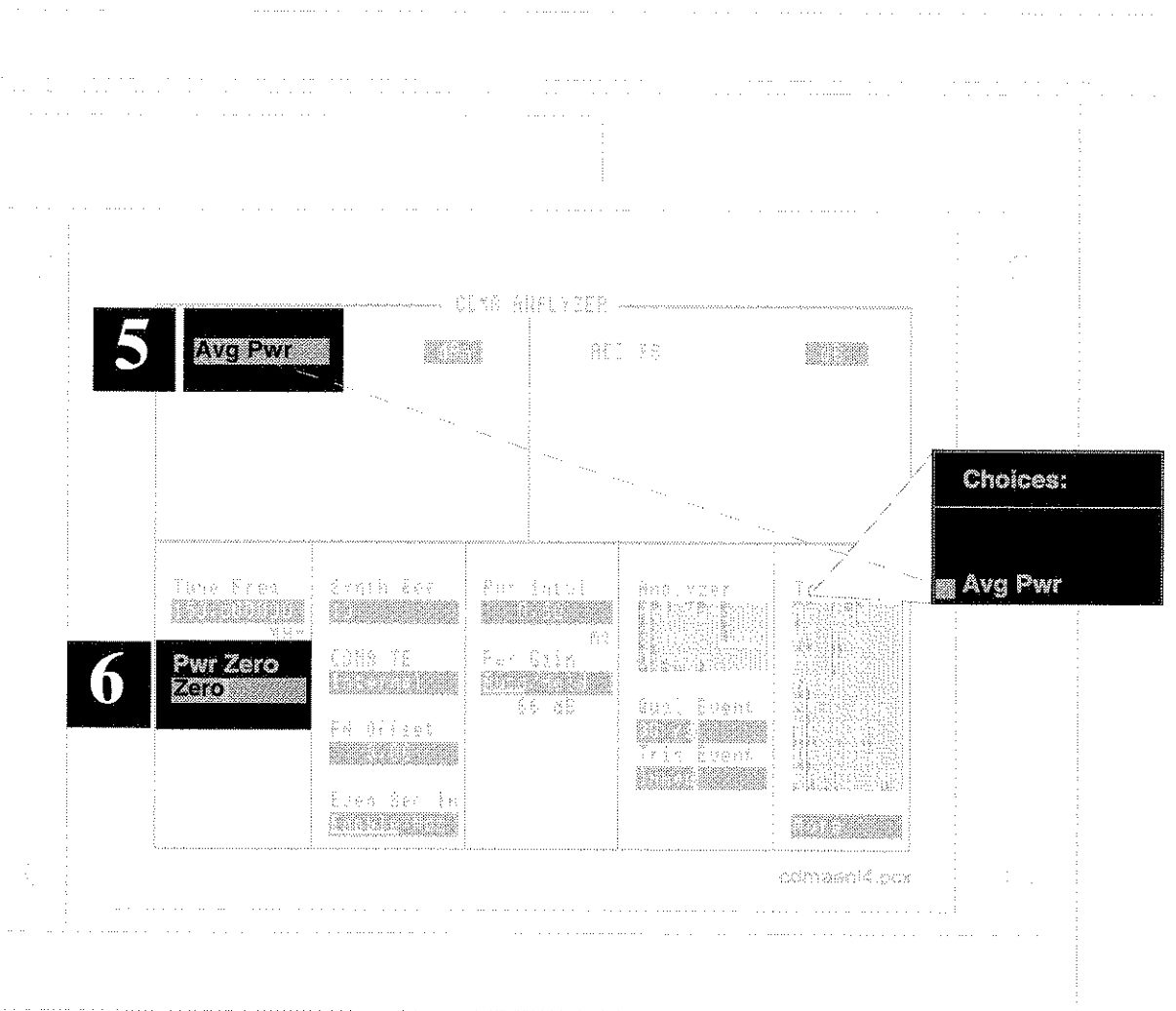

**Step 7** Set the **Tune Freq**. The center frequency of the applied signal must match the frequency entered in the **Tune Freq** field for the correct calibration factors to be applied.

**Step 8** The **Pwr Intvl** field should be set to the maximum value (5.00 ms) unless power is to be measured over a specific time period.

Note: To measure power during a specific time period, set the **Pwr Intvl** field to the desired length and make a triggered measurement.

To measure the power during the power control groups occurring at 80 ms frame clock boundaries example:

1. Set the **Pwr Intvl** to 1.25 ms
2. Set the Trig Event to 80 m.
3. Connect the Base Station's CDMA even second clock output to the Test Set's EVEN SECOND/SYNC IN input.

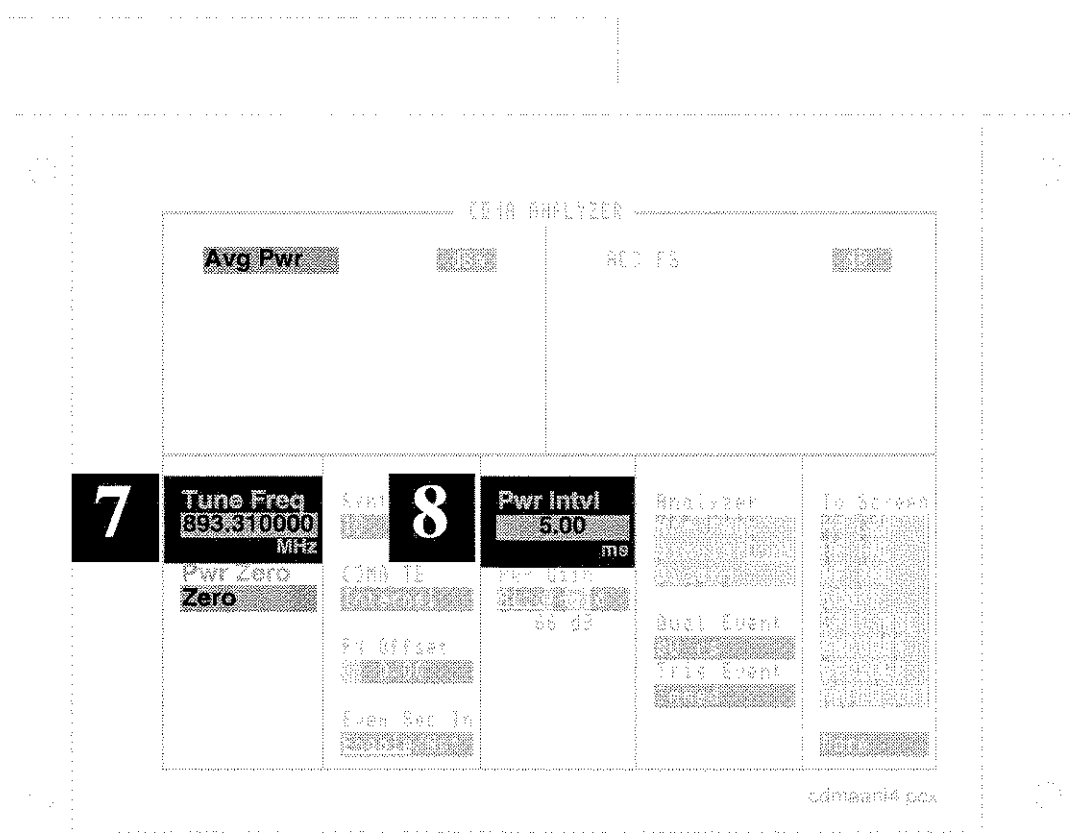

**Step 9** Connect the RF output of your base station to the Test Set's RF IN/OUT port and activate the transmitter.

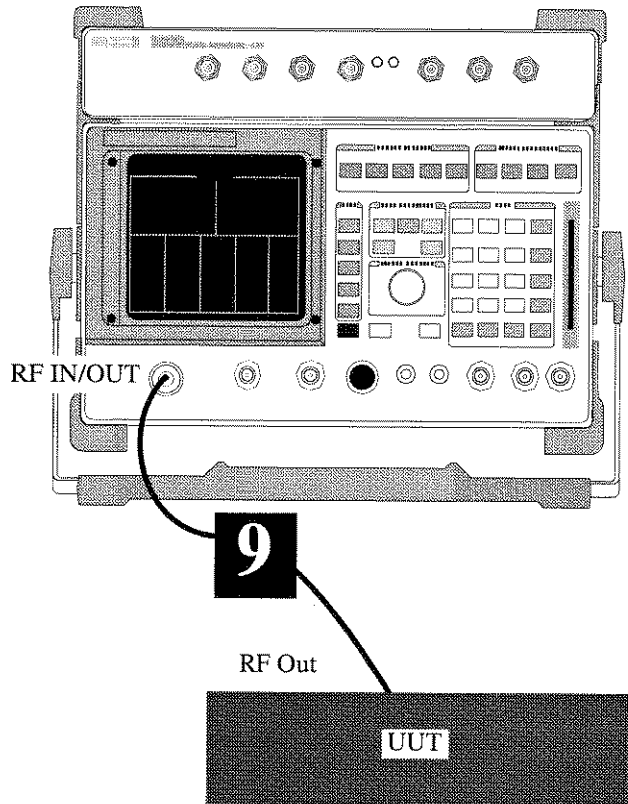

**Measurement Results**

The Avg Pwr and ADC FS measurements are displayed.

If four dashes (----) or a level <-20 dB is displayed, use the **To Screen** menu to access the Test Set's Spectrum Analyzer to verify the presence of the signal. Change the Spectrum Analyzer's **Span** to 5 MHz to display the entire CDMA signal, and change the **Ref Level** to adjust for the signal level.

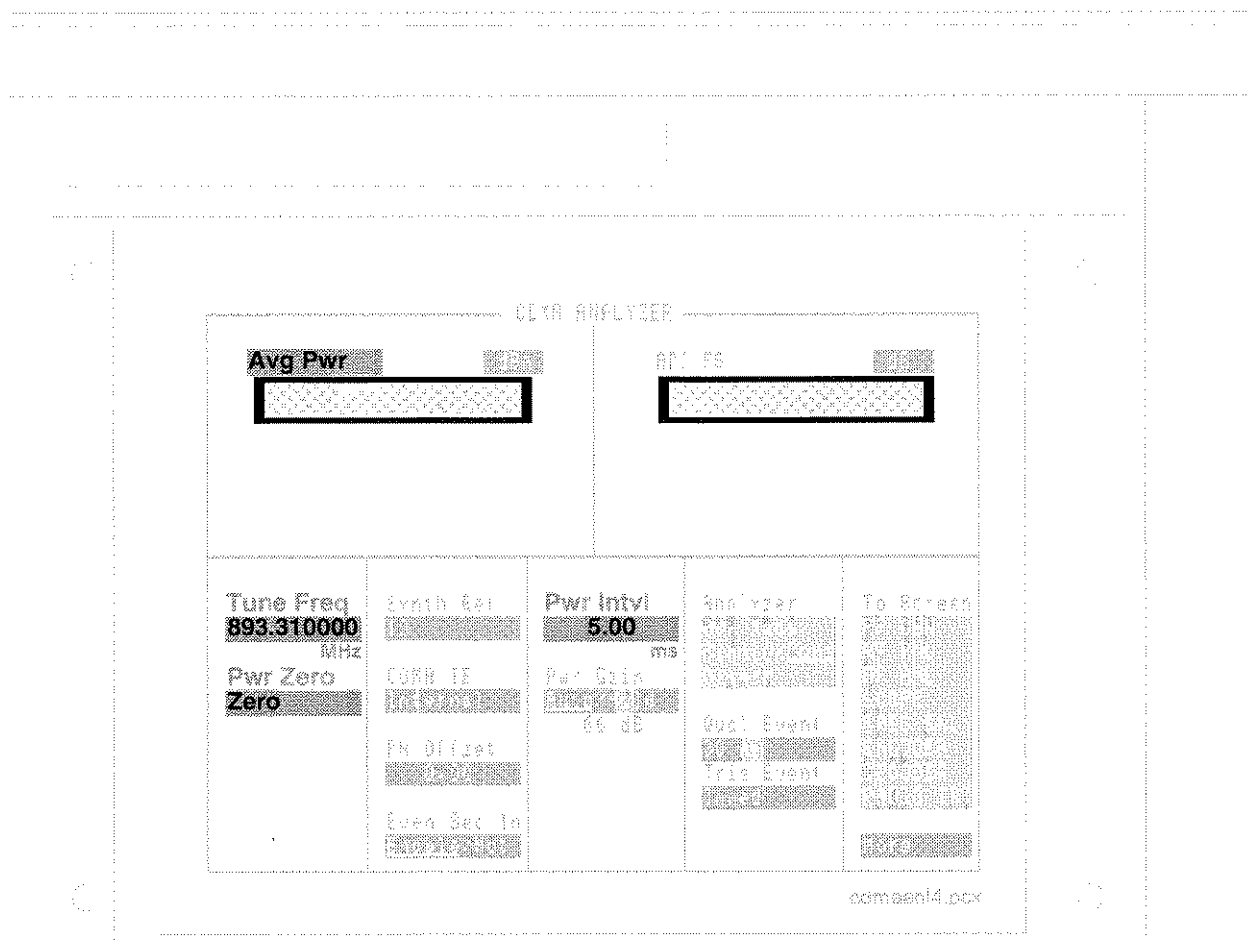

## Channel Power Measurement

The Channel Power measurement requires a short cross-calibration procedure that optimizes measurement accuracy. Calibration factors are generated to force the Channel Power measurement to the same level as Average Power. During this procedure, the Test Set's internal CDMA generator provides the stimulus signal necessary for comparing Average and Channel Power measurements at a given tune frequency. *If the frequency of the signal-under-test changes, the cross-calibration procedure must be re-run.*

Initially, the procedure for cross-calibrating the Channel Power measurement includes zeroing the average power meter. If the calibration procedure has to be repeated because the frequency or assigned CDMA channel is changed, the average power meter does not have to be zeroed again. (Begin calibration by substituting the internal CDMA generator for the signal-under-test, described in step eight of the Channel Power measurement procedure).

Channel Power is an "uncorrelated" measurement; it does not require any external timing signals from the transmitter. The transmitter can be tested in any normal operating condition; no special test mode is needed. This measurement differs from the Average Power measurement by restricting its measurement bandwidth to 1.23 MHz, centered around the Tune Frequency of the analyzer.

---

### **UPGRADING OLDER TEST SETS FOR CHANNEL POWER MEASUREMENTS**

The Channel Power calibration routine requires Average Power measurement capabilities. To measure Average Power (and therefore Channel Power), your HP 8921A Test Set must be equipped with a special Input Module. This assembly provides the Detector Output (DET OUT) signal to the Test Set's rear panel. If you have an earlier version of the HP 8921A Test Set that does not have the DET OUT connector on the rear panel, you must return your instrument to the factory for an upgrade to make these measurements. Contact your HP Field Sales Engineer to arrange upgrades.

For details about the steps in the following procedure, see "**Explanation of the Channel Power Measurement Procedure**" on page 41.

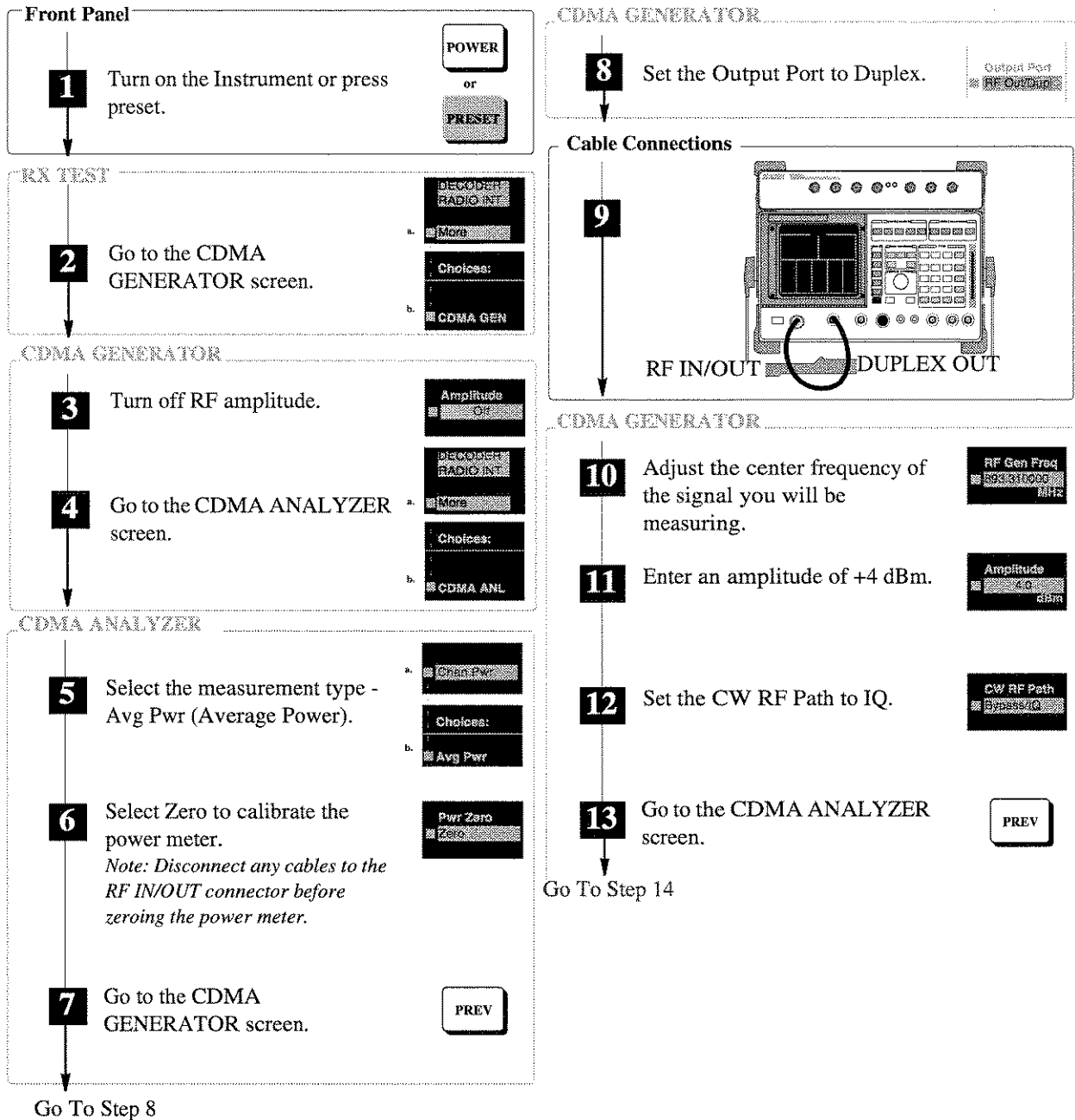

Figure 2 Channel Power Measurement Procedure (1 of 2)

Chapter 2, Making CDMA Measurements  
 Channel Power Measurement

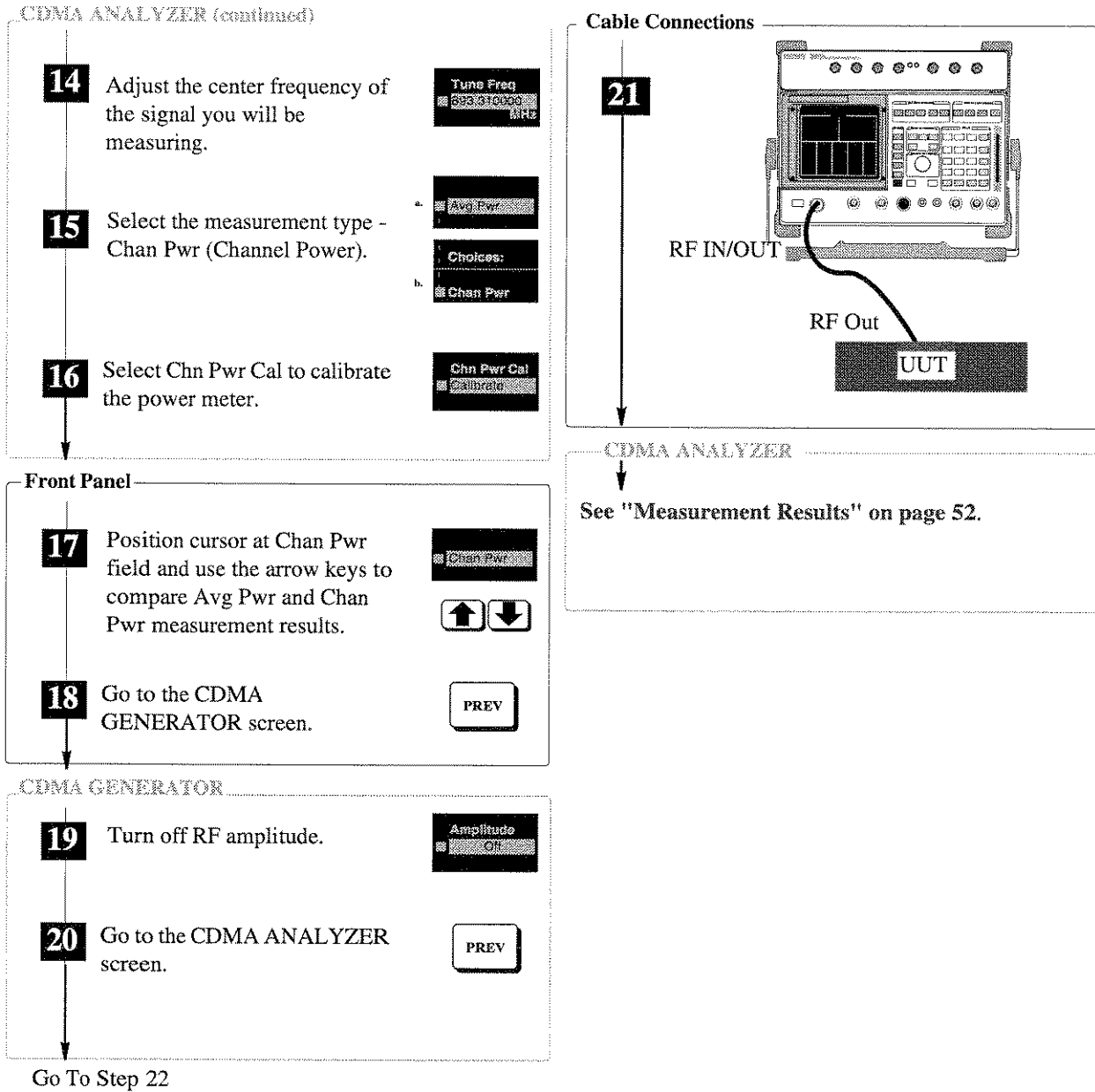

Figure 3 Channel Power Measurement Procedure ( 2 of 2)



### Explanation of the Channel Power Measurement Procedure

These explanations are intended to add detail about the steps required to perform a channel power measurement. For the step by step instruction see figure 2 on page 39 and figure 3 on page 40.

#### Step 1

This sets the instrument to a known state. The RX TEST screen is displayed when completed.

#### Step 2

Select **More** and use the CURSOR CONTROL knob to scroll through the extended list of screens. Select the CDMA GENERATOR screen to access the RF Amplitude field.

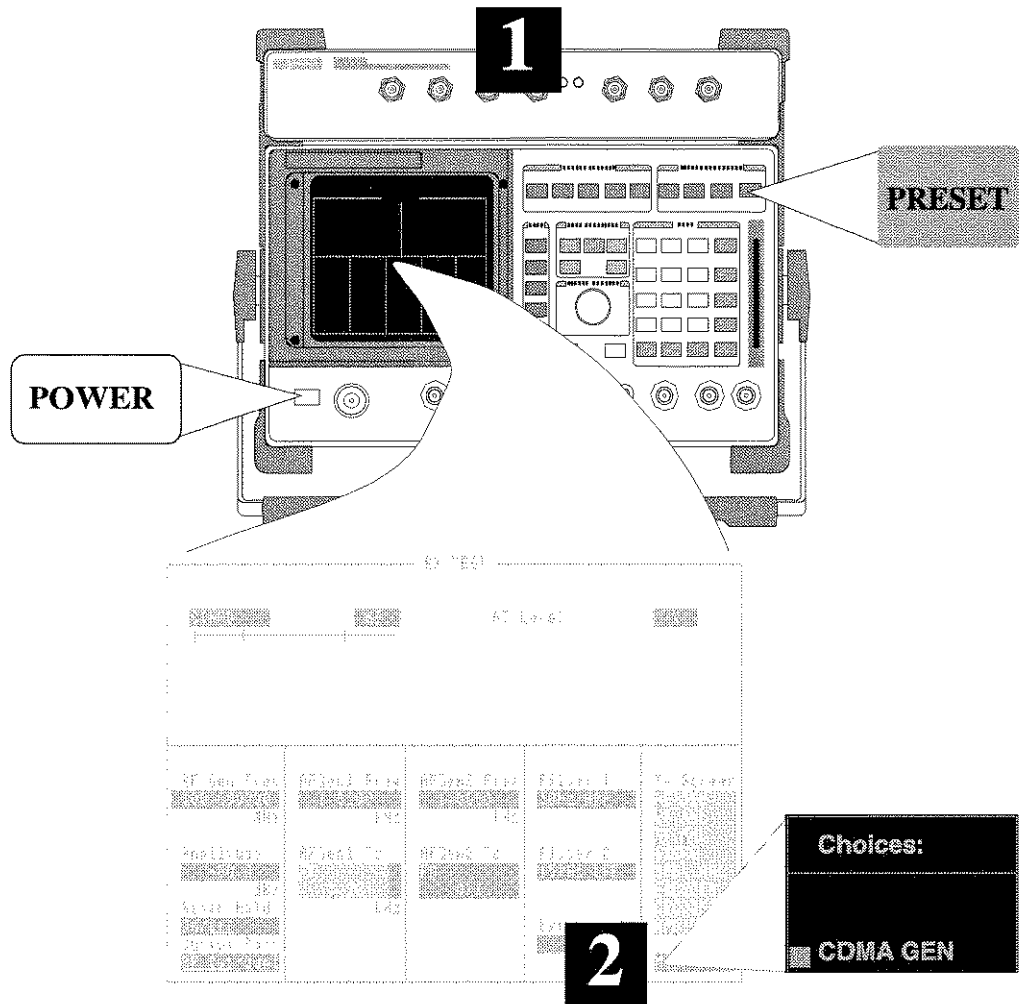

**Step 3** The generator's **Amplitude** is turned Off in preparation for zeroing the average power meter. If **Amplitude** is not turned off, power from the generator will cross-couple to the analyzer and cause the measurement circuitry to zero the average power measurement incorrectly.

**Step 4** Select the **More** field and turn the knob. Select the CDMA ANALYZER screen.

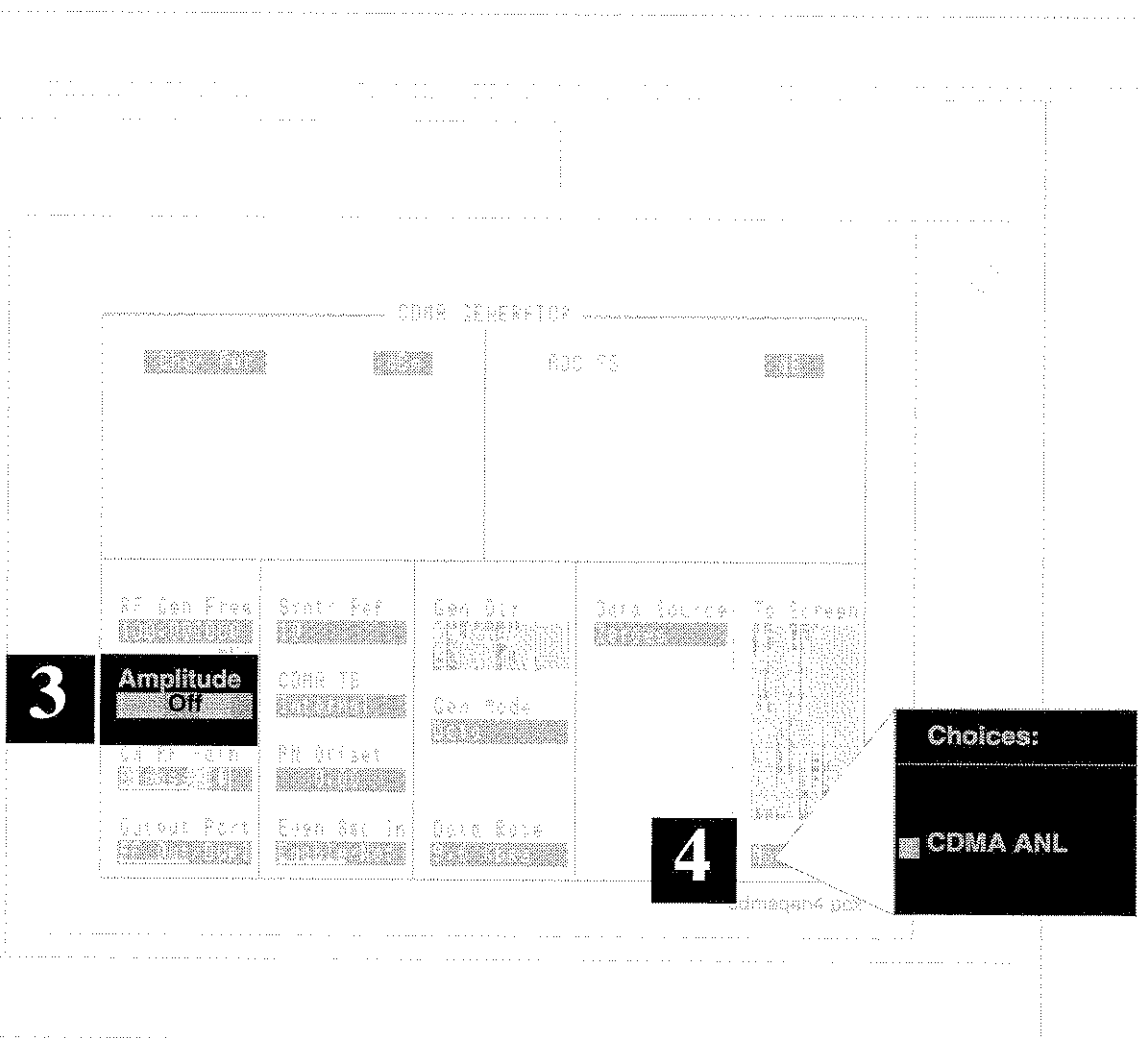

**Step 5** Select the Avg Pwr measurement if it isn't selected already.

**Step 6** The **Pwr Zero** field zeroes the average power meter. When zeroed, the displayed Avg Pwr will be a value  $< -20$  dBm or a series of four dashes (----). If the units are changed to Watts or milliwatts the reading will be very close to 0.0000

**Step 7** Press the PREV key to return to the CDMA GENERATOR screen.

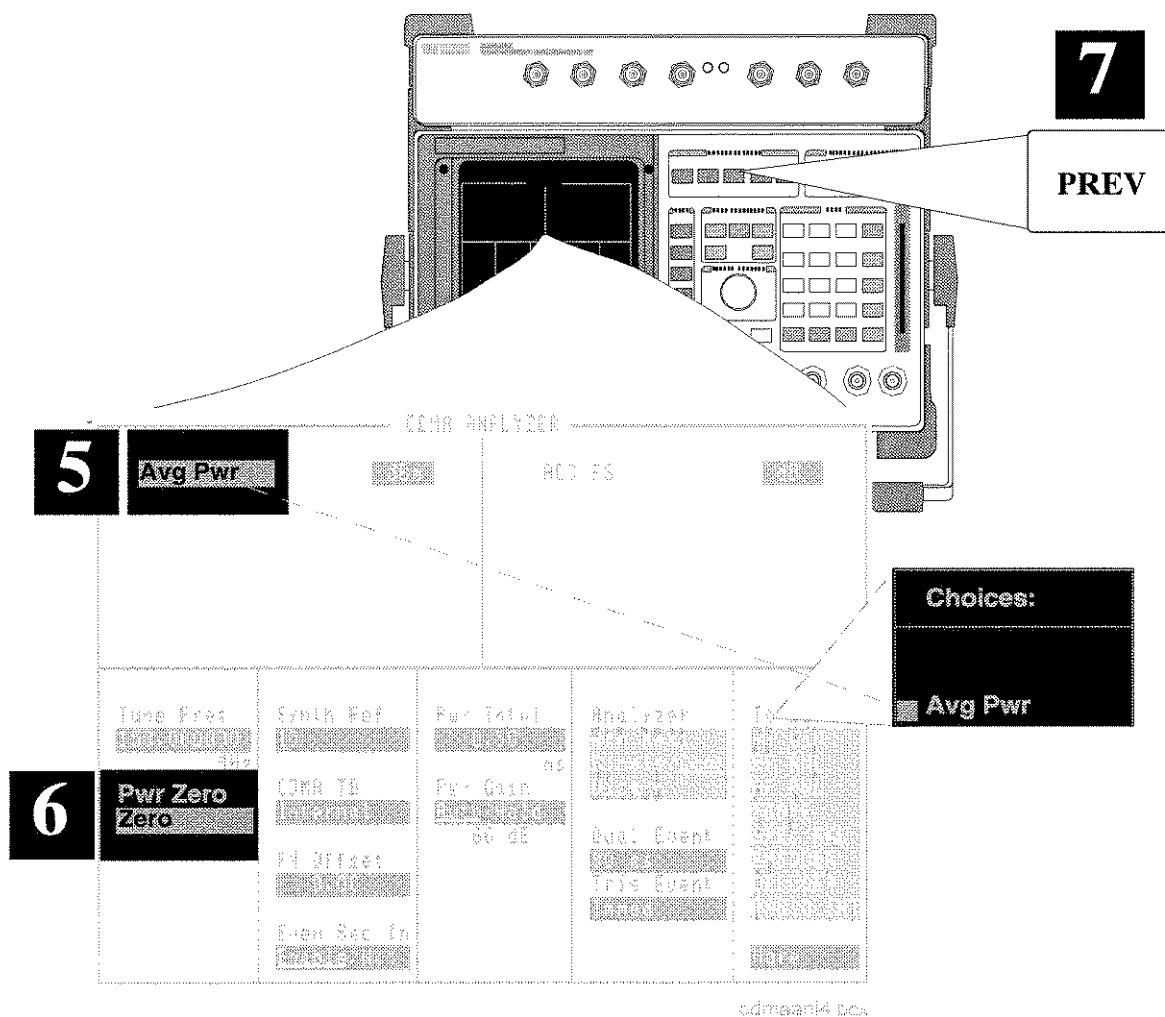

**Step 8** Select Dup1 as the Output Port.

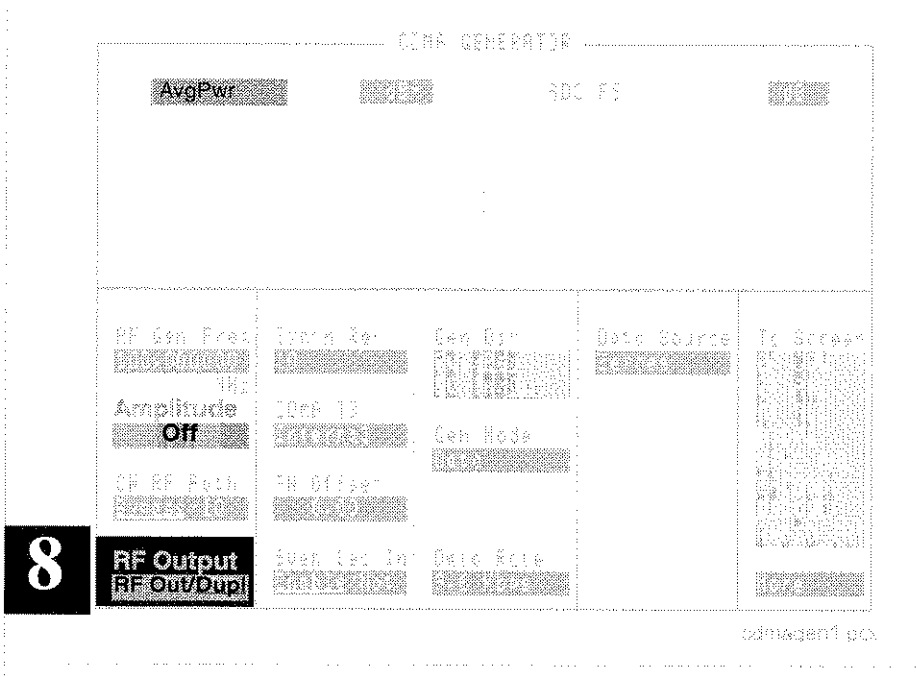

**Step 9**

Connect an external cable from the DUPLEX OUT to RF IN/OUT connectors.

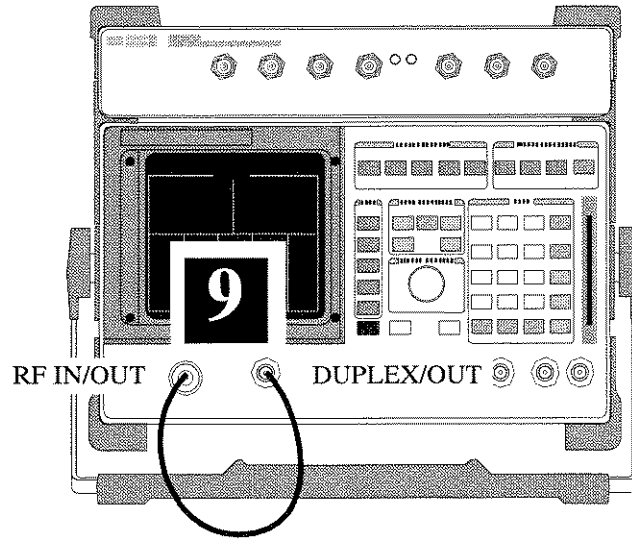

- Step 10** Adjust the **RF Gen Freq** to the center frequency of the channel you will be making a Channel Power measurement on. The internal generator will now be set-up to cross-calibrate Average Power with Channel Power measurements.
- Step 11** Set the **Amplitude** to +4 dBm.
- Step 12** Select **IQ** for the **CW RF Path**.

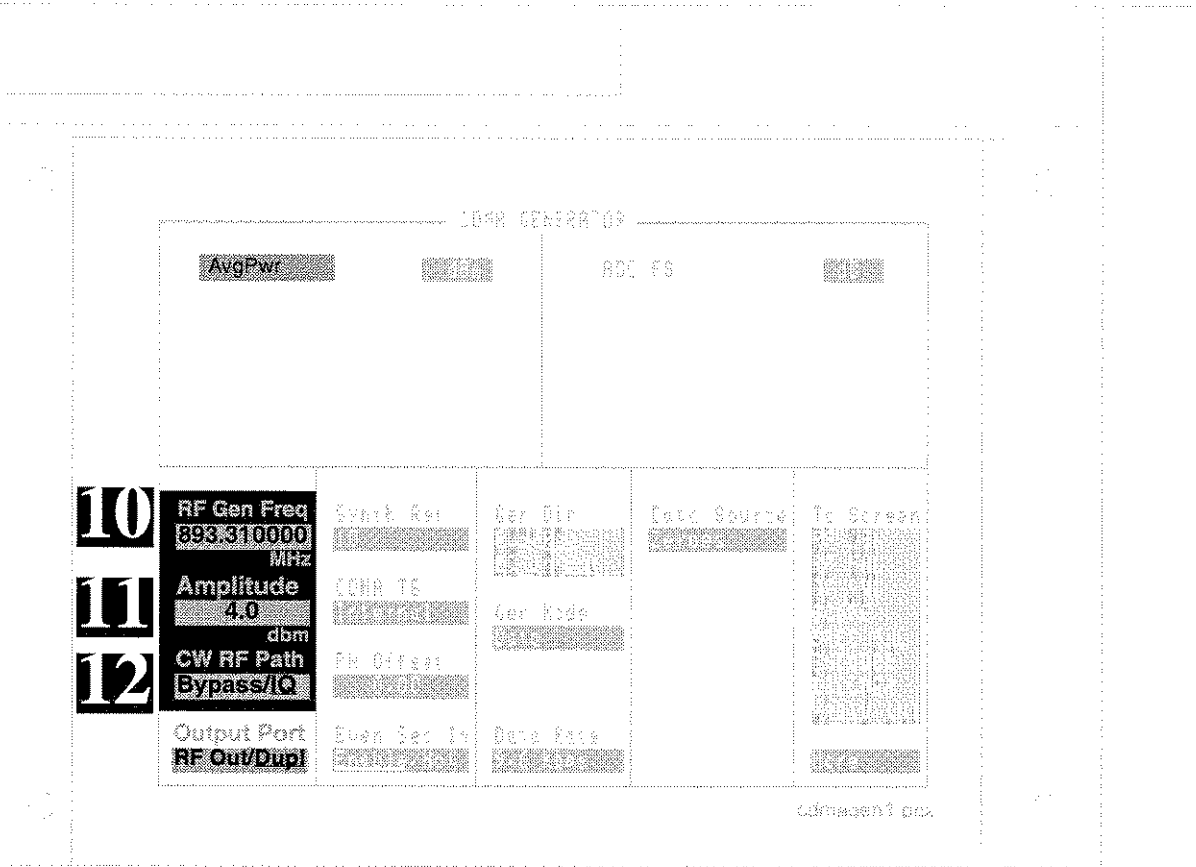

**Step 13** Press the PREV key to return to the CDMA ANALYZER.

**Step 14** Adjust the **Tune Freq** to the center frequency of the signal you will be measuring.

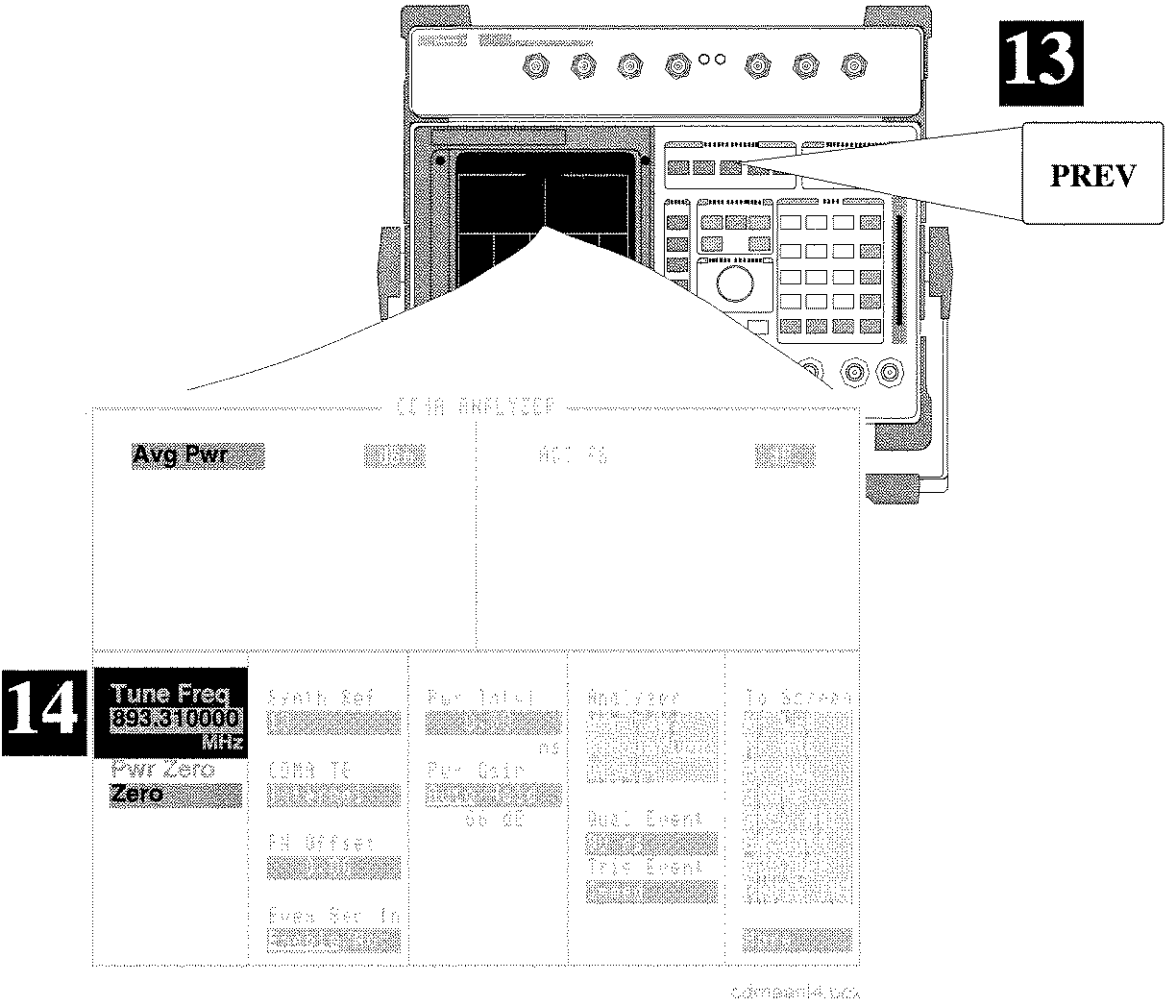

**Step 15** Select **Chan Pwr**. With the cursor positioned in the upper-left field, you can use the up/down arrow keys to select **Chan Pwr**.

**Step 16** With the cursor positioned at the **Chn Pwr Cal** field, press the knob. This starts a calibration routine that cross-calibrates Average Power and Channel Power at each input attenuator setting. *This routine is complete when the Calibrate field is no longer highlighted.*

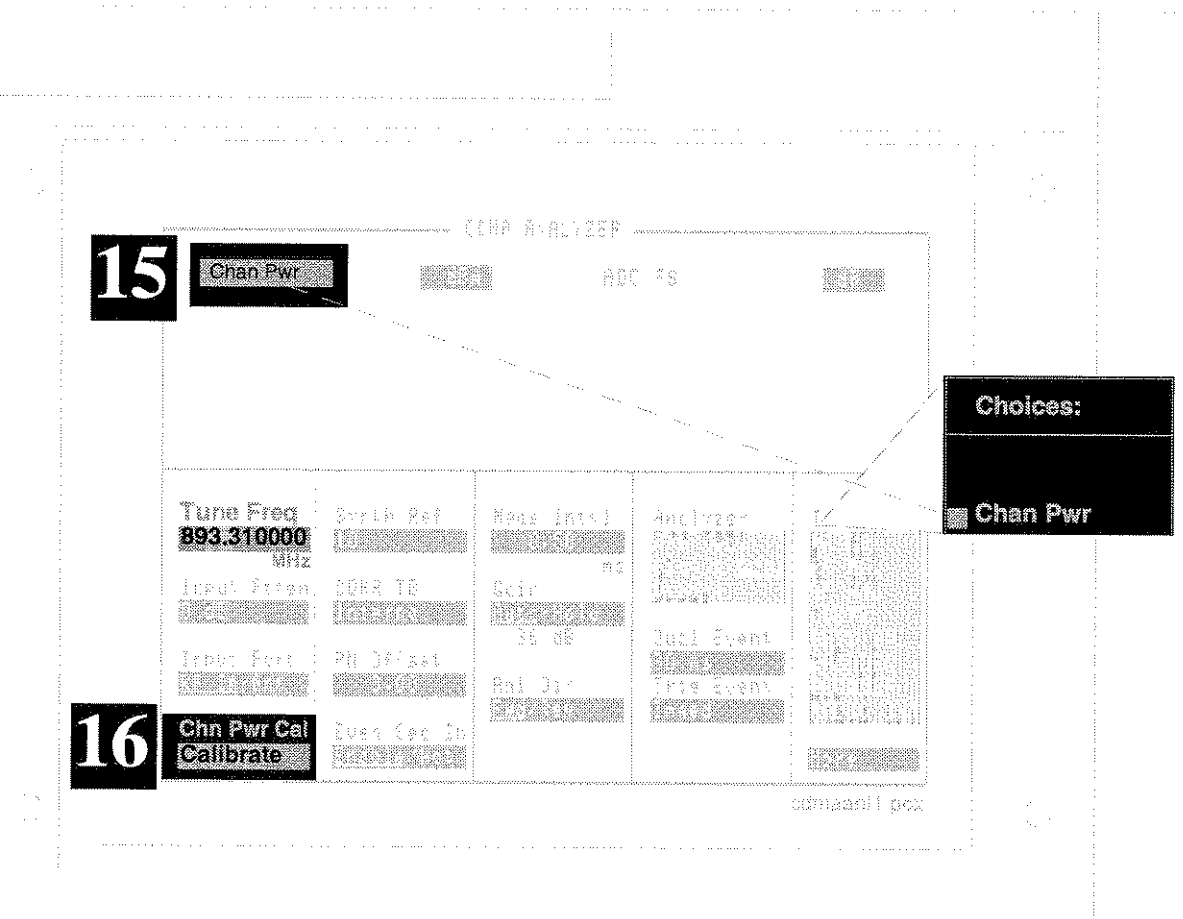



**Step 17** Use the Up/Down arrow keys to compare the **Avg Pwr** with the **Chan Pwr**. If the calibration process was successful, they should be closely matched.

**Step 18** Press the **PREV** key to return to the **CDMA GENERATOR** screen.

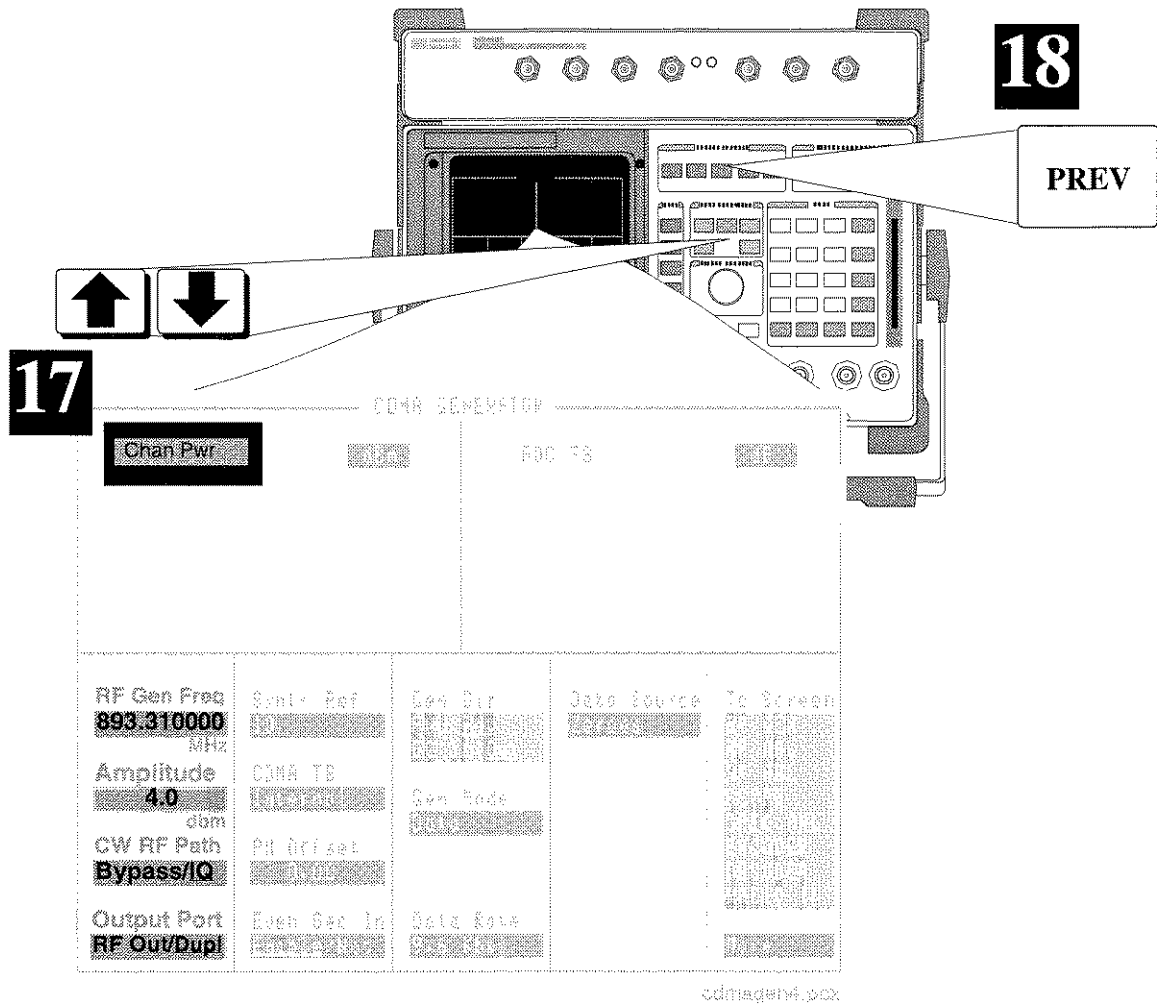

**Step 19** Turn off **Amplitude..**

**Step 20** Press the **PREV** key to return to the **CDMA ANALYZER** screen.

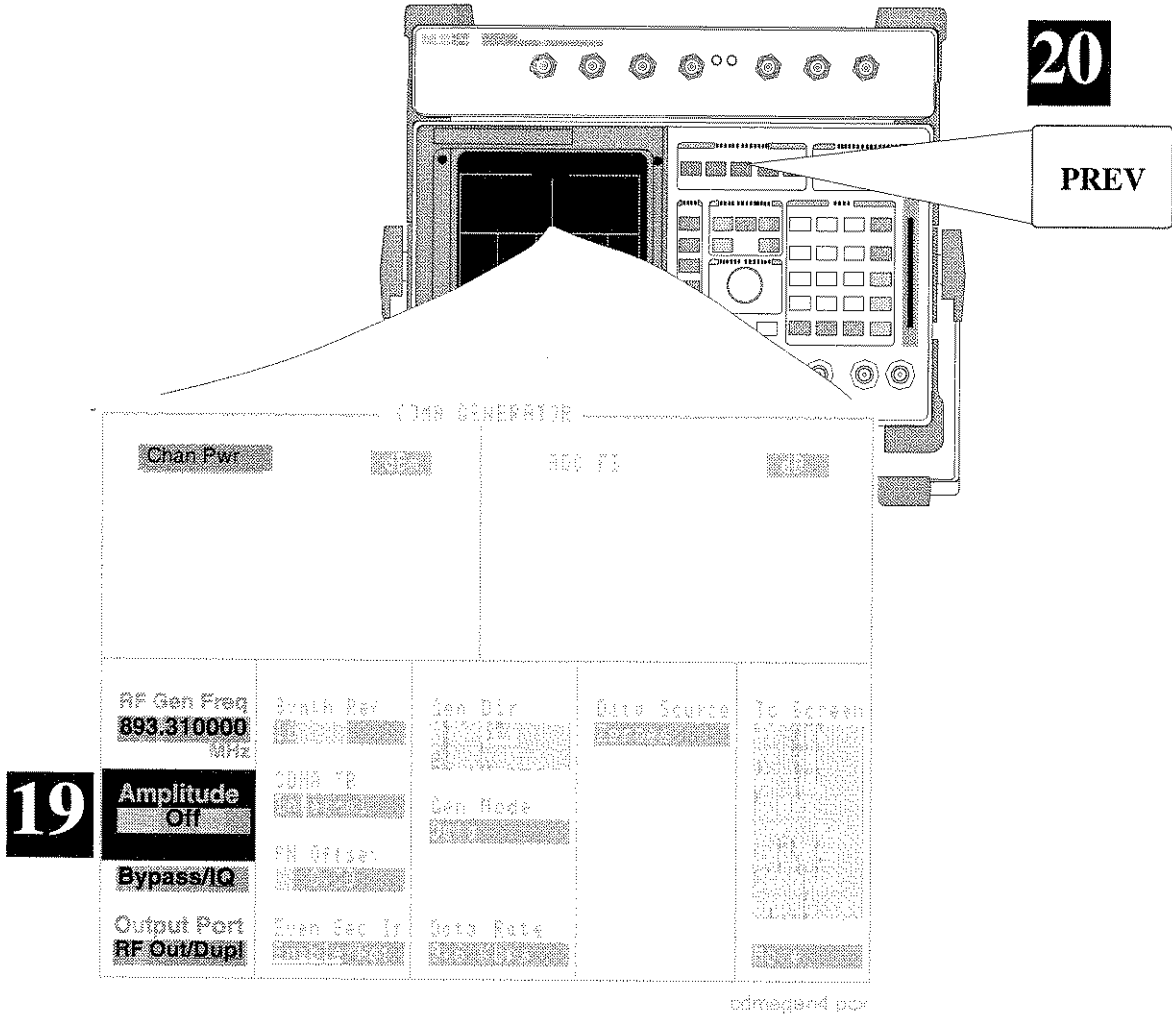

**Step 21**

Remove the cable connecting the DUPLEX OUT and RF IN/OUT connectors and connect your transmitter output to the RF IN/OUT connector.

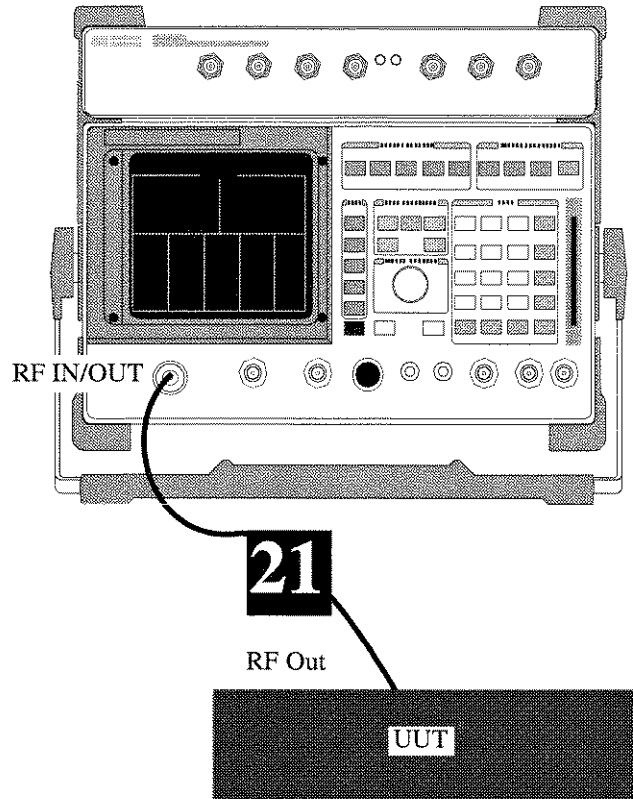

**Measurement Results**

You are now ready to read your Chan Pwr measurement results. Re-calibrate the Channel Power measurement if the center frequency or CDMA channel of your transmitter changes.

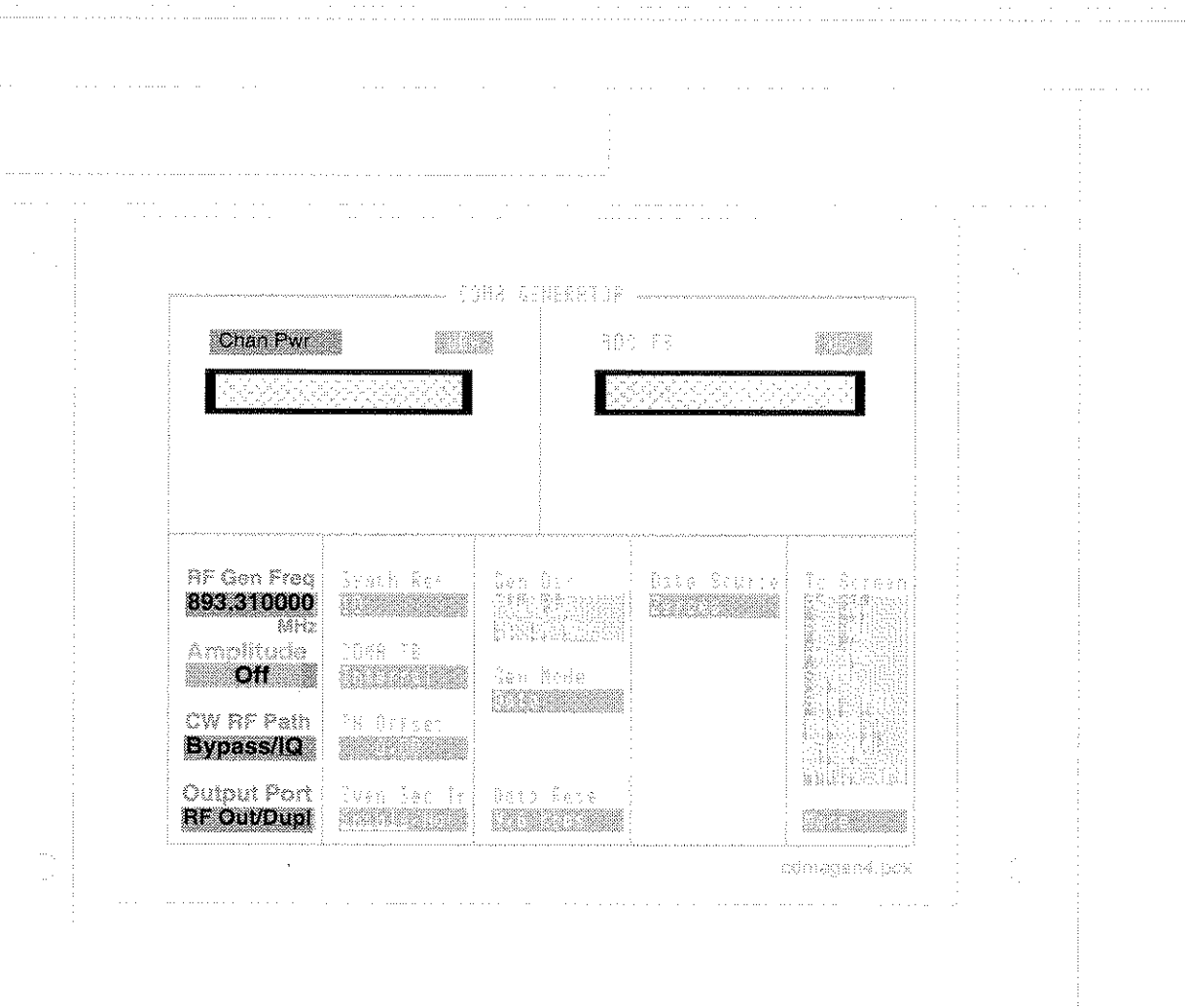

---

## Waveform Quality (Rho) and Error Vector Magnitude (EVM) Measurements

Rho and EVM are correlated measurements that require synchronization signals from the base station to the Cellular Adapter. The base station must be in a test mode that only transmits a pilot channel (Walsh 0).

The PN Sequence Offset Index of the base station must be known to synchronize the base station's signal to the CDMA Analyzer.

These measurements should be made directly on the transmit port of the base station when possible; any other signals present may degrade the measurements (the CDMA Analyzer interprets these signals as noise from your base station).

For details about the steps in the procedure on the following page, see **"Explanation of the Rho and EVM Measurement Procedure"** on page 55.

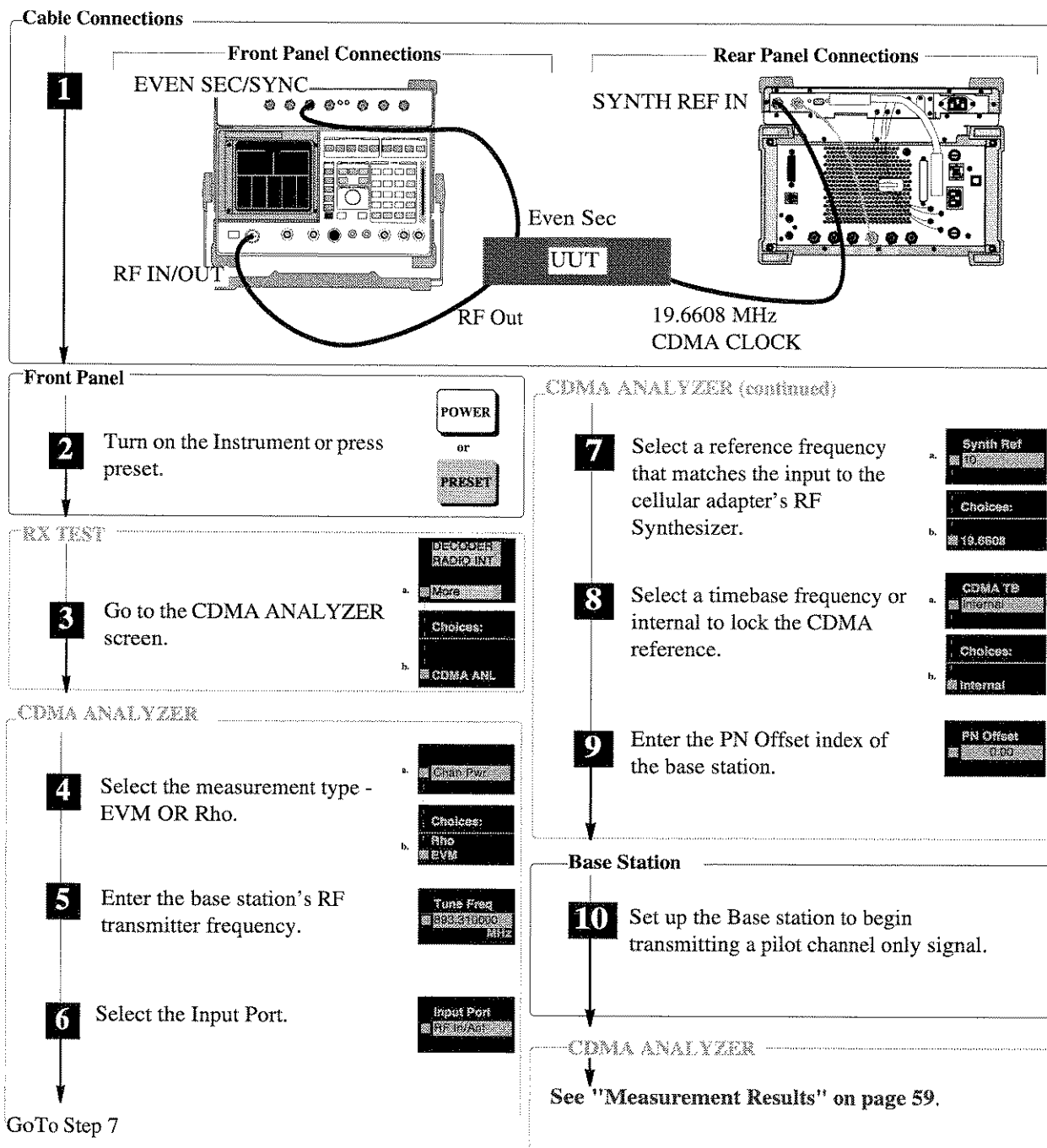

Figure 4 Waveform Quality and Error Vector Magnitude Measurement Procedure

### Explanation of the Rho and EVM Measurement Procedure

These explanations are intended to add detail about the steps required to perform the waveform quality and EVM measurements. For the step by step instruction see "Waveform Quality and Error Vector Magnitude Measurement Procedure" on page 54.

#### Step 1

The rear panel SYNTH REF connector of the Cellular Adapter is connected to the base station's 19.6608 MHz clock to phase-lock the timebase in the Cellular Adapter to the base station. The 10 MHz output of the Cellular Adapter is derived from that signal, and is connected to the Test Set to phase lock it to the other two devices.

The Even Second clock of the base station provides the system timing reference signal for making the measurements.

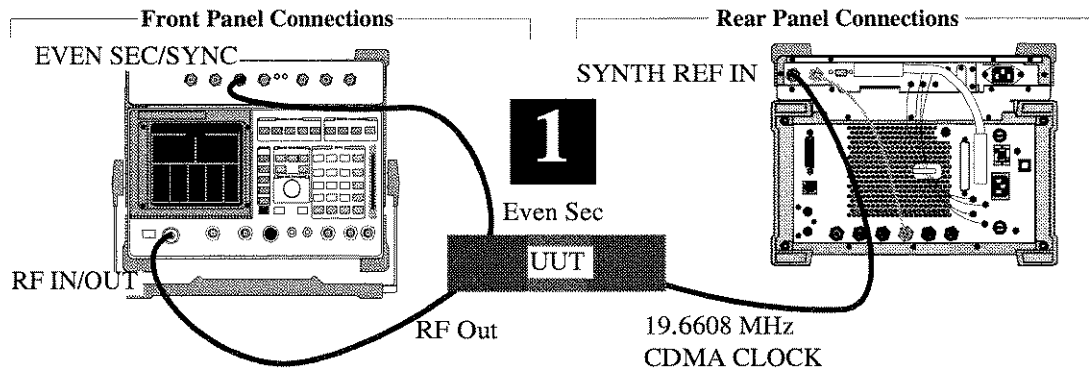

**Step 2** This sets the instruments to a known state. The **RX TEST** screen is displayed when ready.

**Step 3** Selecting the More field displays a list of screens to choose from, including all of the CDMA screens. The Rho and EVM measurement are setup on the CDMA ANALYZER screen.

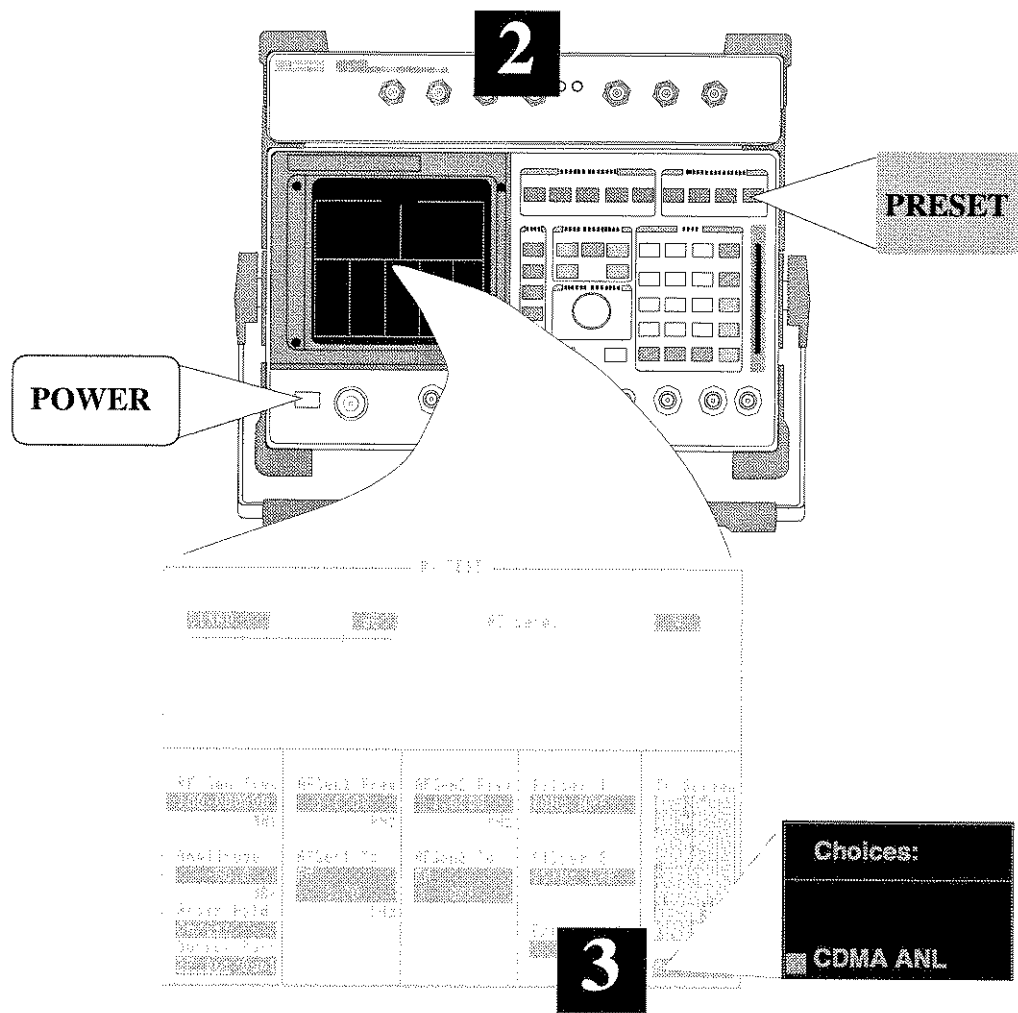



**Step 4** The default measurement is **Avg Pwr**. By moving the cursor in front of this measurement and pressing the knob, you bring up a list of measurements to choose from. Select **Rho** or **EVM**.

**Step 5** The **Tune Freq** field is used to enter the center frequency of the CDMA channel being analyzed. The keypad is typically used to enter the frequency, but you can also directly enter the channel number if you prefer.

**TO ENTER THE CHANNEL NUMBER** Channel tuning is selected on the **CONFIGURE** screen using the fields in the **RF Display** column. (Set **RF Display** to **Chan**. Set **RF Chan Std** to **LS AMPS**.) Refer to the **CONFIGURE** screen description in the Test Set's User's Guide.

**Step 6** Refer to see chapter 5, "Connectors, Indicators, and Miscellaneous Hardware" for input level suggestions. Under no circumstances should the signal applied to the ANT IN port exceed 200mW (23 dBm).

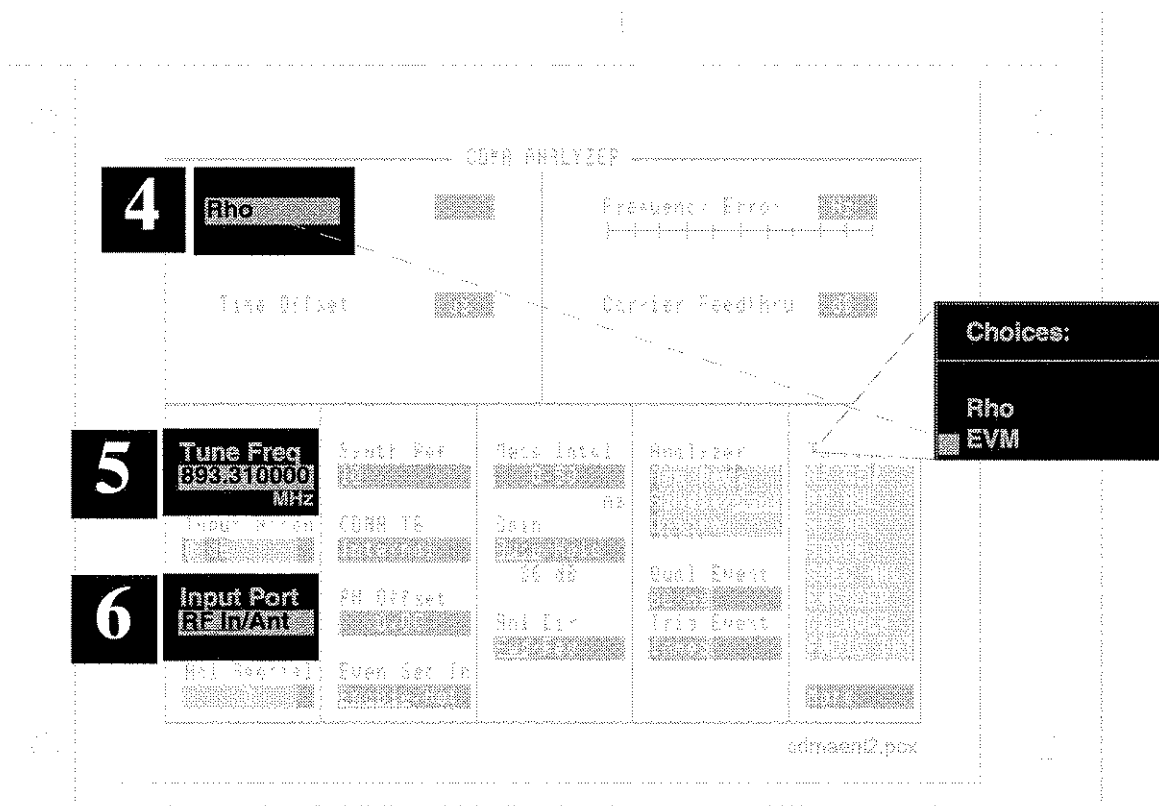

**Step 7** The Synthesizer Reference is used to phase lock the Cellular Adapter's RF synthesizer to the base station. This signal is also used to create the 10 MHz REF OUT signal to phase lock the Test Set to the Cellular Adapter. The REF UNLOCK indicator on the Cellular Adapter should not be lit if the signal selected for the **Synth Ref** field matches the signal connected to the SYNTH REF IN connector.

**Step 8** When the instruments are connected as shown, and internal is selected in the **CDMA TB** field, the CDMA Timebase for the Cellular Adapter is locked to the signal applied to the SYNTH REF IN connector.

**Step 9** The PN Offset of your base station must be entered for the CDMA Analyzer to correctly align its measurement interval with the incoming block of transmitted data.

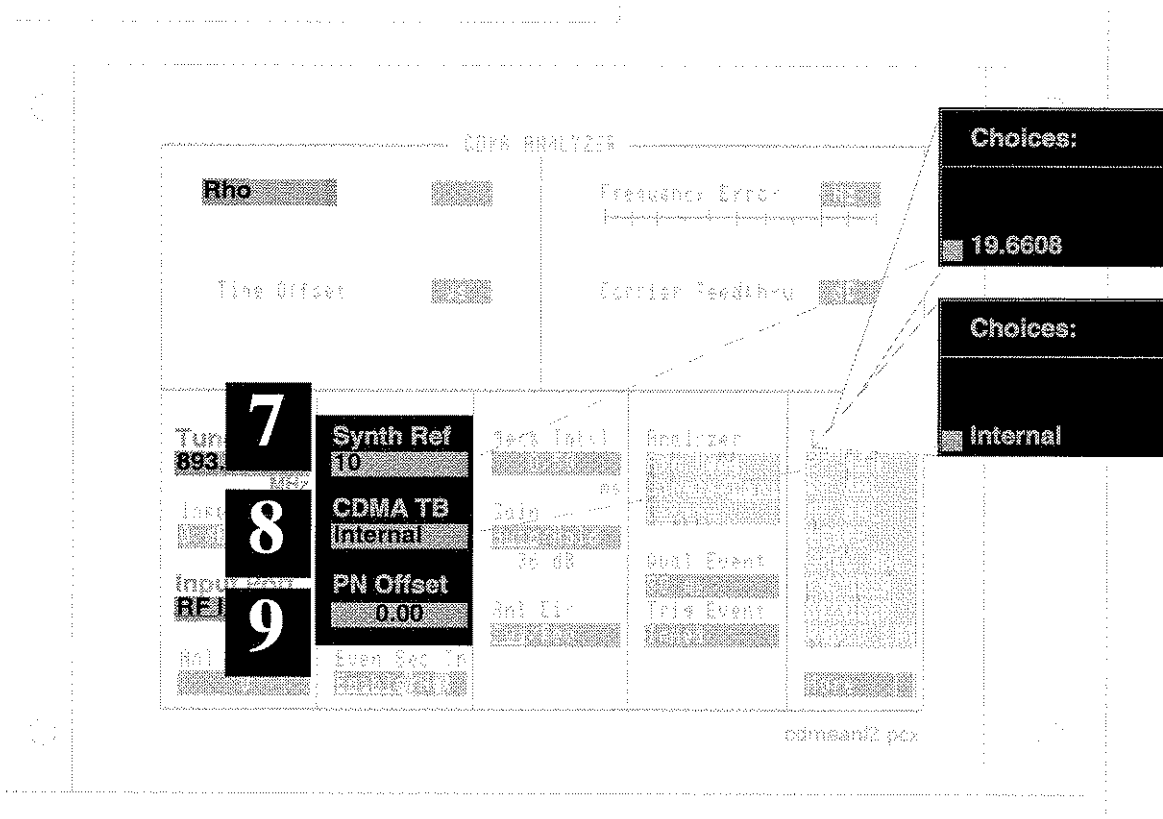

**Step 10** The base station must only be transmitting a pilot channel (Walsh 0)

**Measurement Results**

Rho (and Time Offset, Frequency Error, and Carrier Feedthru) or EVM (and Magnitude Error and Phase Error) should be displayed.

If no measurement is displayed, verify all instrument settings and connections. You can use the Test Set's Spectrum Analyzer to verify the presence and levels of the 19.6608 MHz and CDMA carrier signals from your base station.

For a discussion about the signal requirements for the SYNTH REF IN connector, see "SYNTH REF IN" on page 145.

For additional troubleshooting information see chapter 3, "Troubleshooting Measurement Problems"

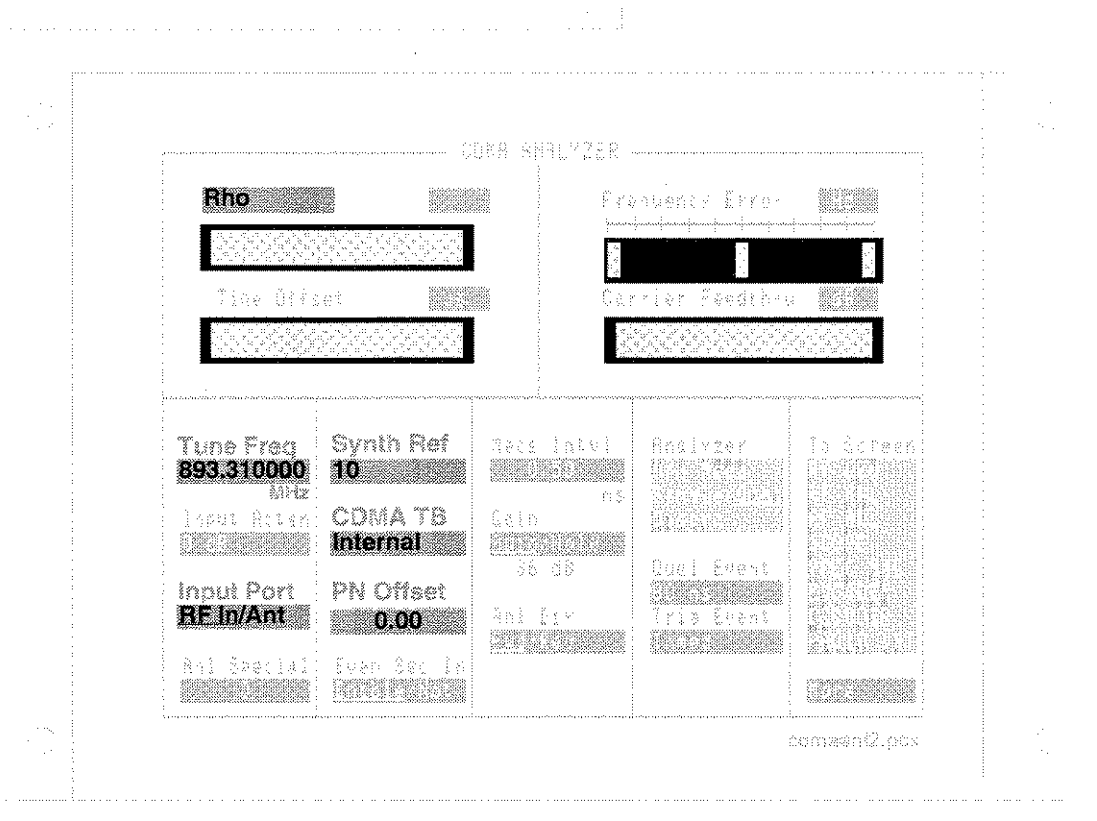

## Code Domain Power, Fast Power, Phase, and Timing

All Code Domain measurements are correlated to external synchronization signals from the base station.

The PN Sequence Offset Index of the base station must be known to synchronize the base station's signal to the Code Domain Analyzer.

The instrument setup and cabling is identical, in most respects, to the setup used for Rho and EVM measurements. If you have already set up your instruments to measure Rho or EVM, you can start making Code Domain measurements by just going to the Code Domain Analyzer screen and set the **Measurement** field to **Cont.**

For details about the steps in the procedure on the following page, see **"Explanation of the Code Domain Measurements Procedure"** on page 62.

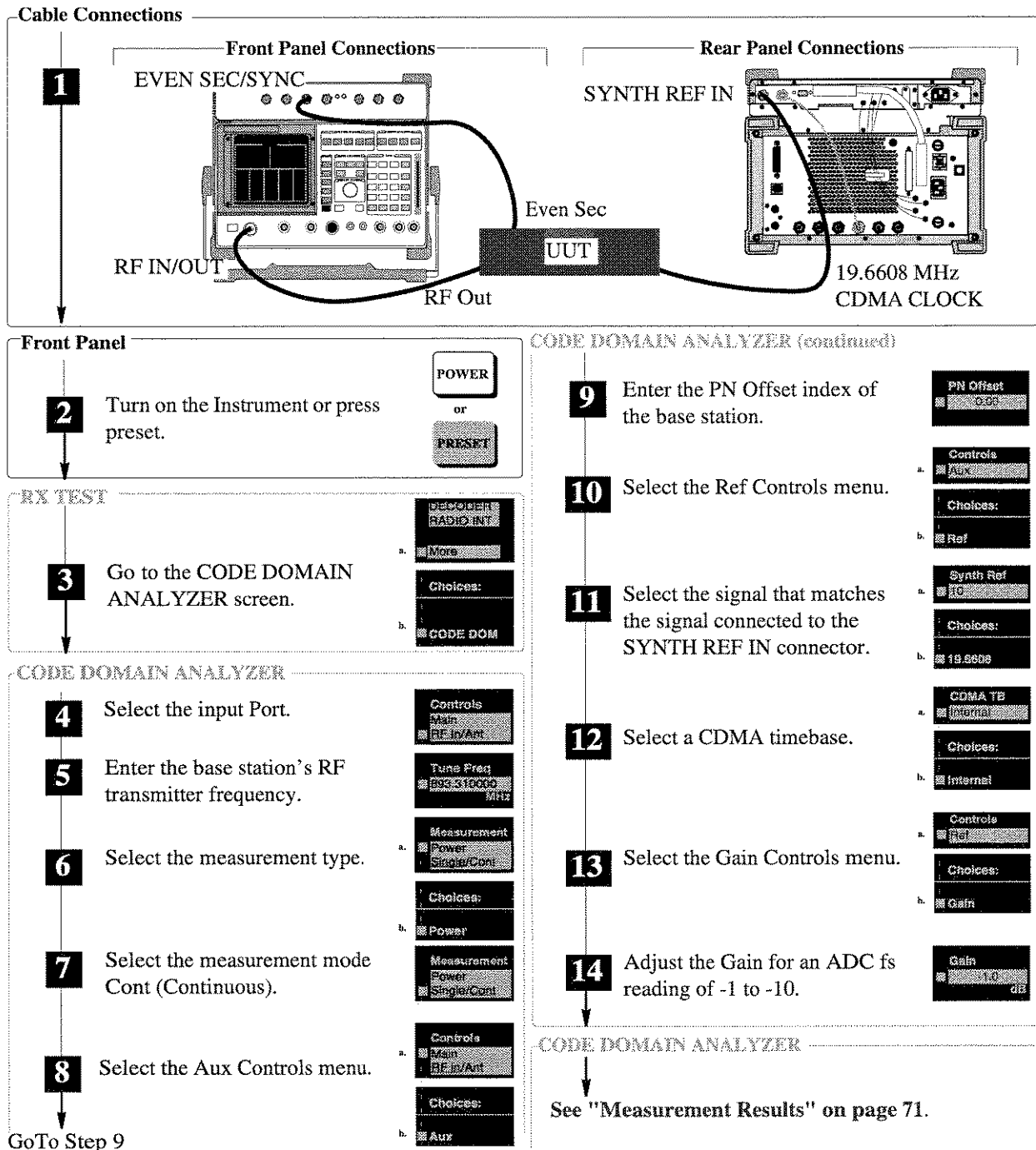

**Figure 5** Code Domain Power, Phase, and Timing Measurement Procedure

### Explanation of the Code Domain Measurements Procedure

These explanations are intended to add detail about the steps required to perform a code domain measurements. For the step by step instruction see "Code Domain Power, Phase, and Timing Measurement Procedure" on page 61.

#### Step 1

The rear panel SYNTH REF connector of the Cellular Adapter is connected to the base station's 19.6608 MHz clock to phase-lock the timebase in the Cellular Adapter to the base station. The 10 MHz output of the Cellular Adapter is derived from that signal, and is connected to the Test Set to phase lock it to the other two devices.

The Even Second clock of the base station provides the system timing reference signal for making the measurements.

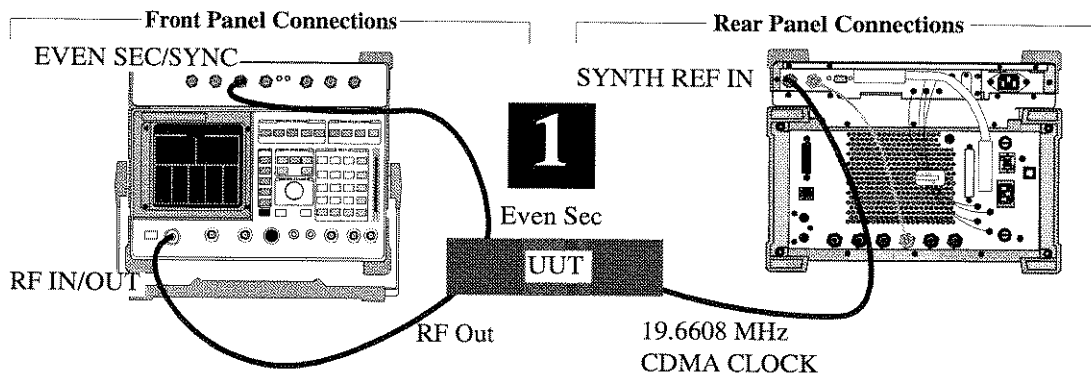

**Step 2** This sets the instruments to a known state. The **RX TEST** screen is displayed when ready.

**Step 3** Selecting the More field displays a list of screens to choose from, including all of the CDMA screens. Selecting **CODE DOM** accesses the **CODE DOMAIN ANALYZER** screen.

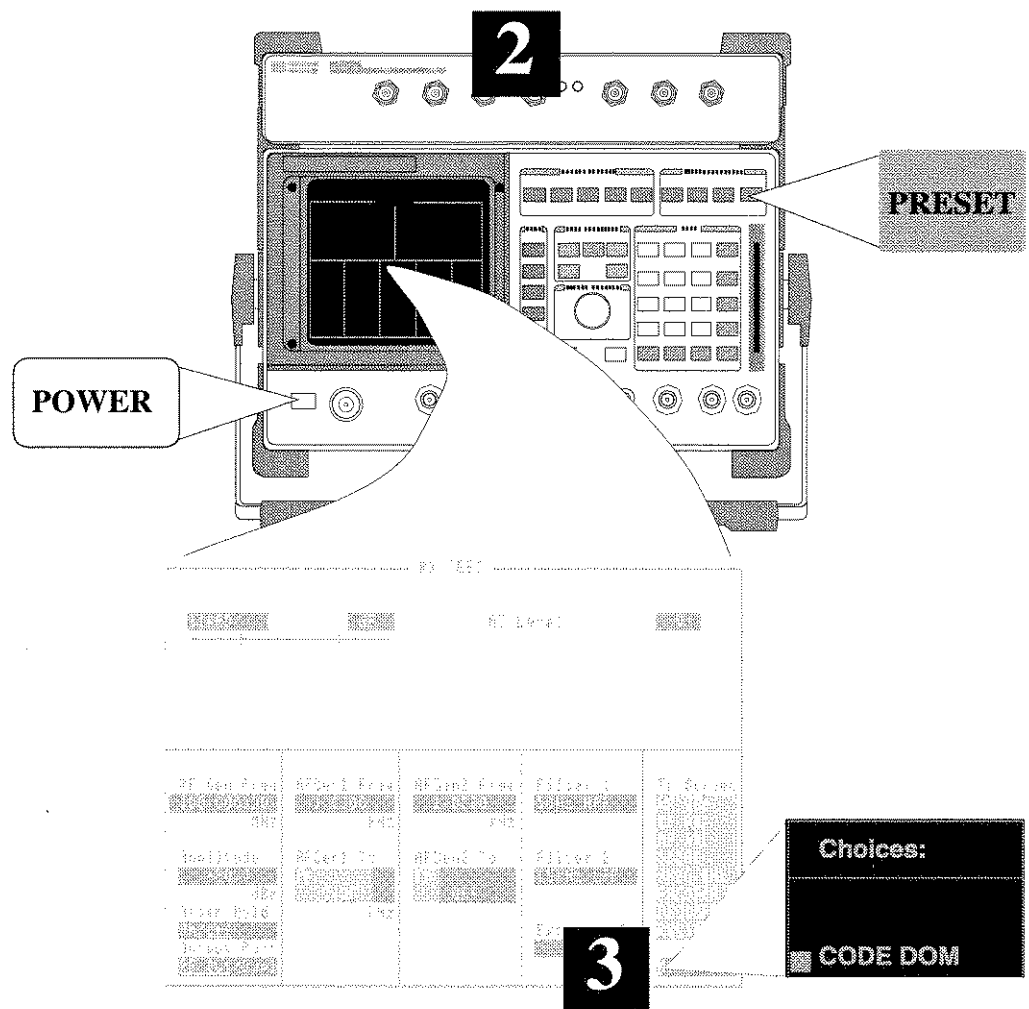

**Step 4** Refer to see chapter 5, "Connectors, Indicators, and Miscellaneous Hardware" for input level suggestions. Under no circumstances should the signal applied to the ANT IN port exceed 200mW (23 dBm).

**Step 5** The **Tune Freq** field is used to enter the center frequency of the CDMA channel being analyzed. The keypad is typically used to enter the frequency, but you can also directly enter the channel number if you prefer.

**TO ENTER THE CHANNEL NUMBER**

Channel tuning is selected on the **CONFIGURE** screen using the fields in the **RF Display** column. (Set **RF Display** to **Chan**. Set **RF Chan Std** to **LS AMPS**.) Refer to the **CONFIGURE** screen description in the Test Set's User's Guide.

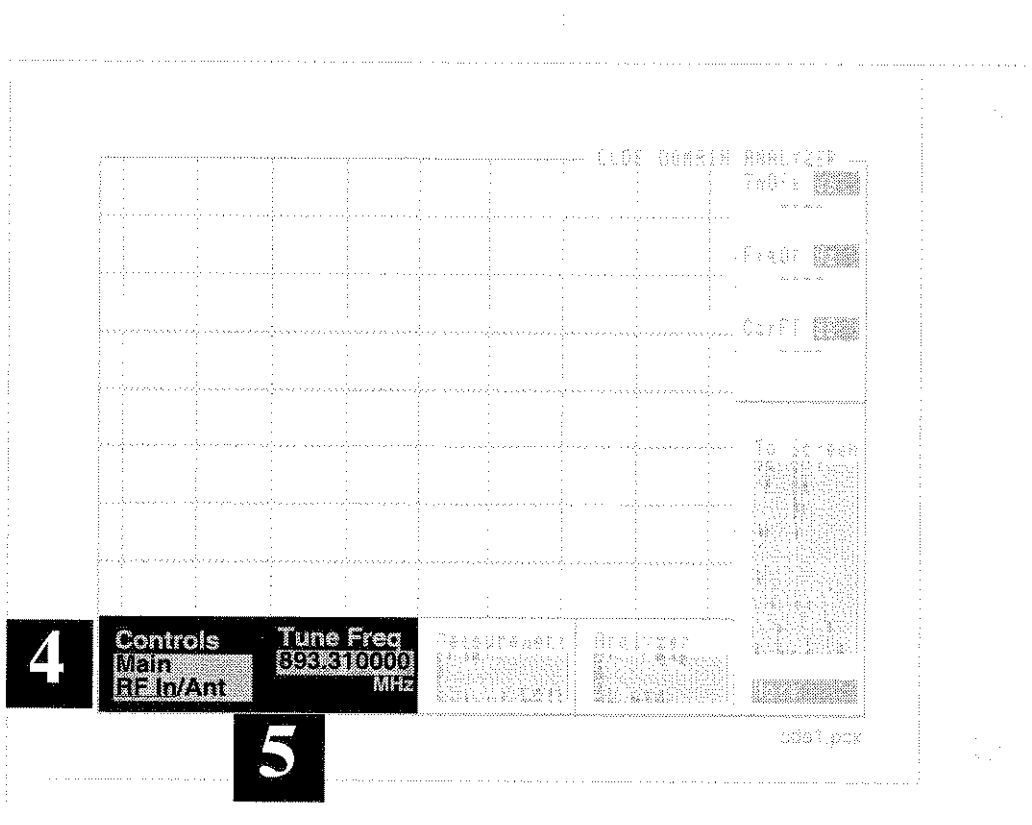



**Step 6**

The Measurement field is used to select the Code Domain measurement type.

If you want to make a **Fast Pwr** measurement, you need to acquire a measured Time Offset value. Time Offset will be measured during Power, Phase and Timing measurements in the Code Domain Analyzer, or during Rho measurements in the CDMA Analyzer. If you have not acquired a Time Offset value, select the Power, Phase, or Timing measurement and continue with these steps. After measurement results are displayed, follow these steps:

1. Select **FP Setup** from the Controls field.
2. Use **Ofs Trnsfer** to transfer the measured value from the **Tm ofs** field to the **Time Offset** field. (After performing this step the values in the **Time Offset** field and the **Tm ofs** fields should match).
3. Access the top field under Controls, select Main and, under Measurement select **Fast Pwr**. Fast Power measurements should now be displayed.

**NOTE:**

If, during a Fast Power measurement, the Data Rate, PN Offset, CDMA TB, or Synth Ref fields settings are changed, you must acquire a new Time Offset value by making a Power Phase, Timing, or Rho measurement.

See "Ofs Trnsfer" on page 129 for more information.

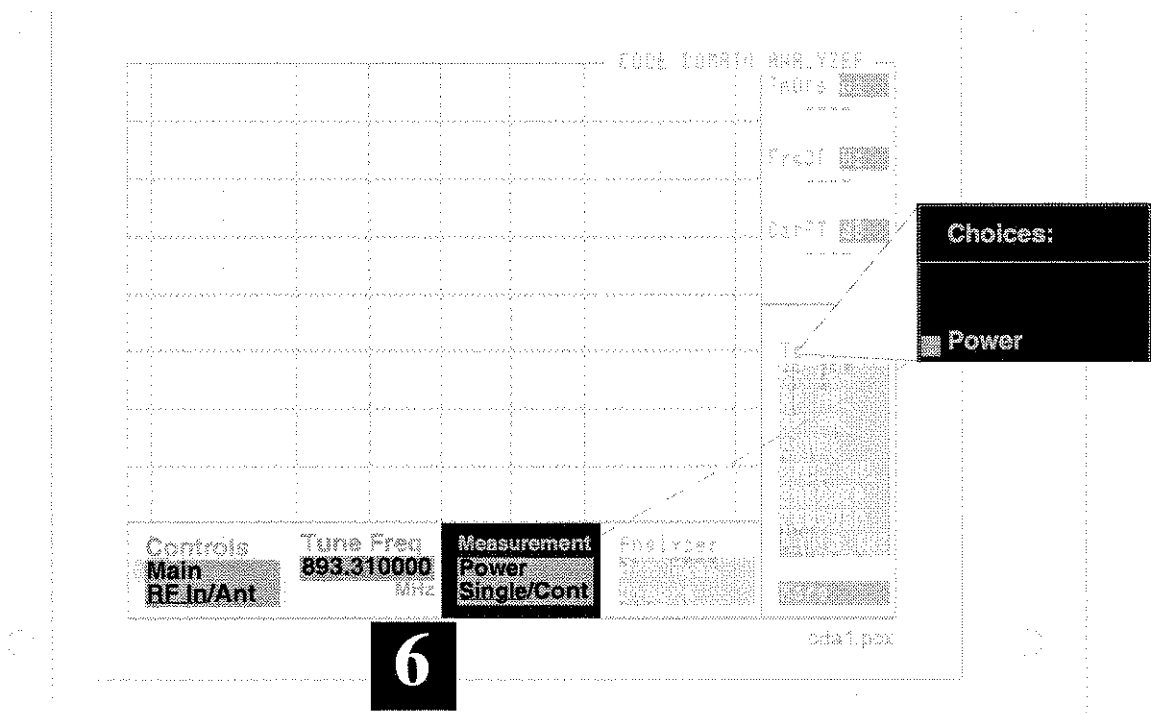

**Step 7** Selecting **Cont** immediately arms the analyzer and re-arms it after each measurement. Measurements are continuously made and updated until **Single** is selected.

If **Single** is selected, you must select **Arm Meas** each time you want to make a measurement.

**Step 8** The **Controls** field is used to access a variety of control menus. Change the **Main** entry to **Aux** (Auxiliary).

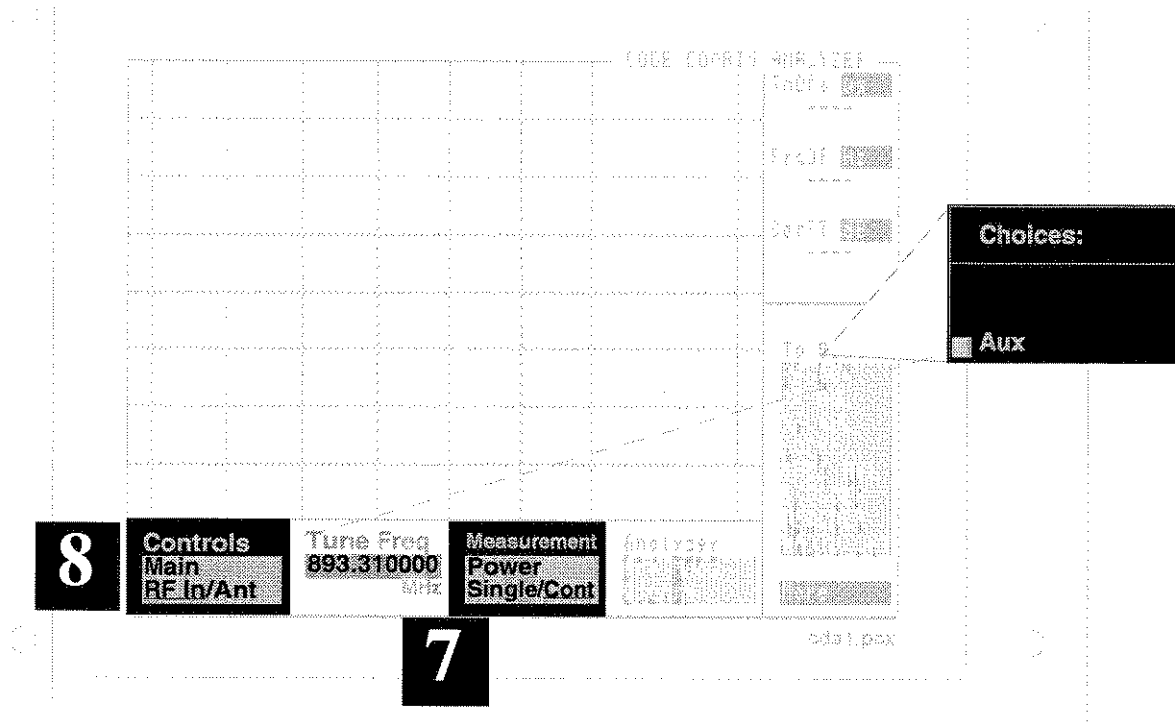

**Step 9** Enter the PN Sequence Offset Index (**PN Offset**) of your base station to synchronize the analyzer's timing to the base station's signal.

**Step 10** Change the **Controls** field to **Refs** (References) to access and change the **Synth Ref** field.

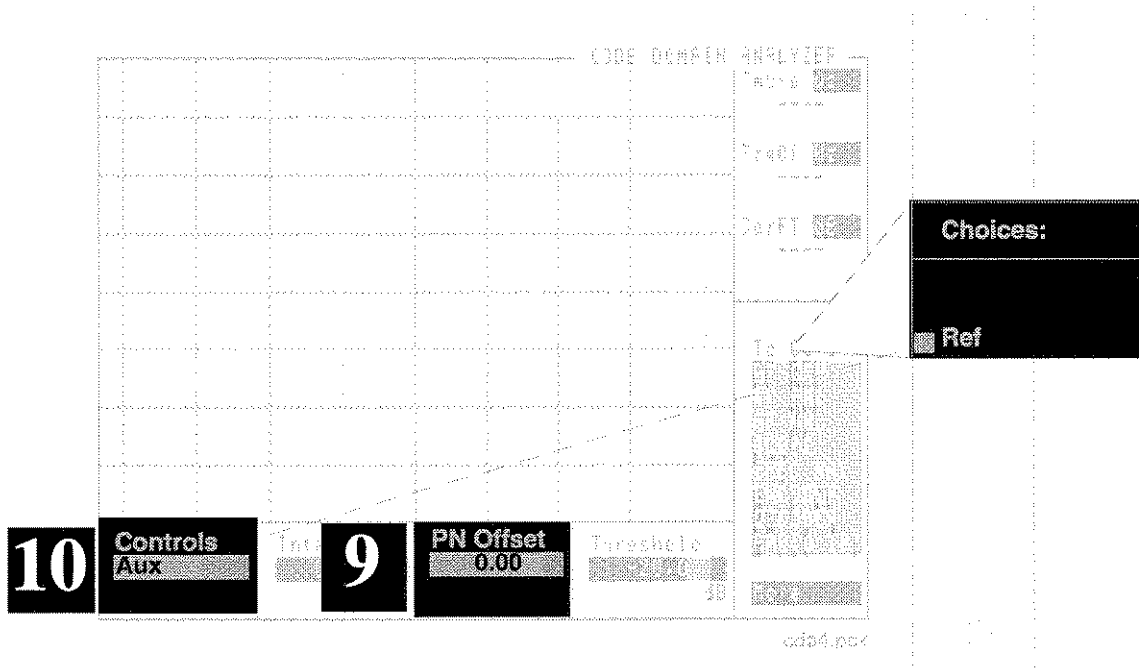

**Step 11** The Synthesizer Reference is used to phase lock the Cellular Adapter's RF synthesizer to the base station. This signal is also used to create the 10 MHz REF OUT signal to phase lock the Cellular Adapter to the Test Set. The REF UNLOCK indicator on the Cellular Adapter should not be lit if the signal selected for the **Synth Ref** field matches the signal connected to the SYNTH REF IN connector.

**Step 12** When the instruments are connected as shown, and internal is selected in the **CDMA TB** field, the CDMA Timebase for the Cellular Adapter is locked to the signal applied to the SYNTH REF IN connector.

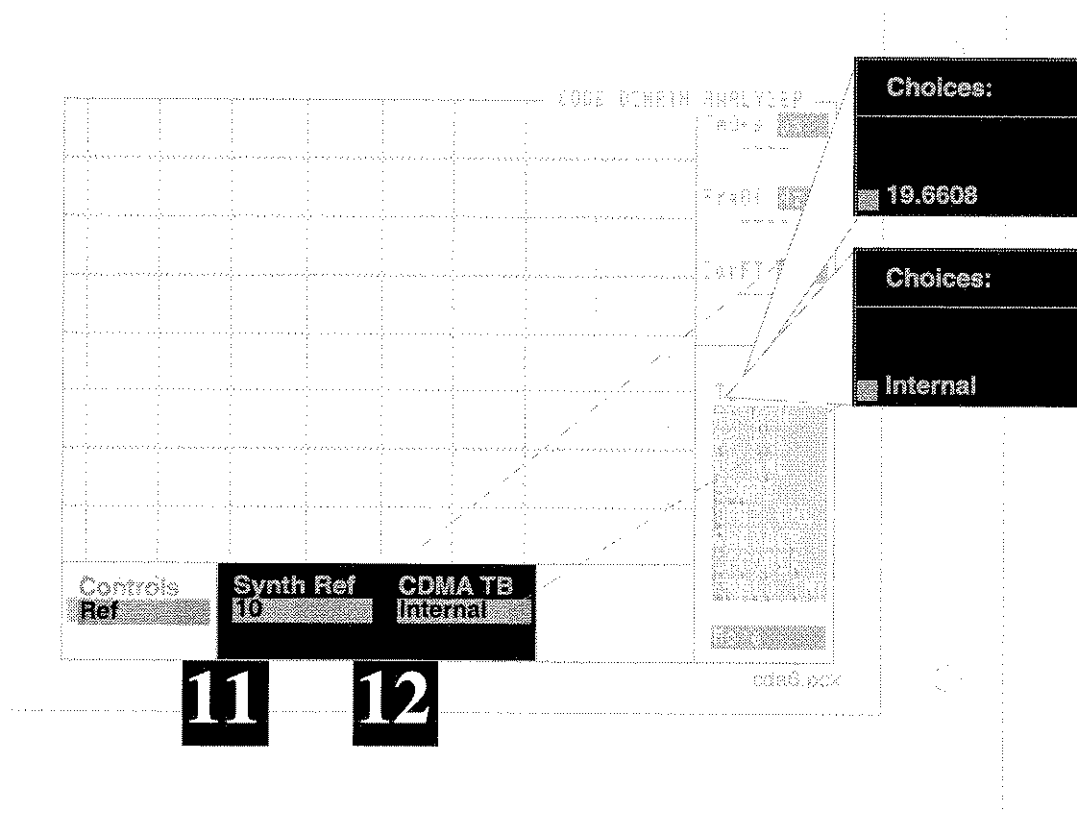

**Step 13**

The **Gain** field adjusts the level of the signal into the Code Domain Analyzer. Access this field by changing the **Controls** menu to **Gain**.

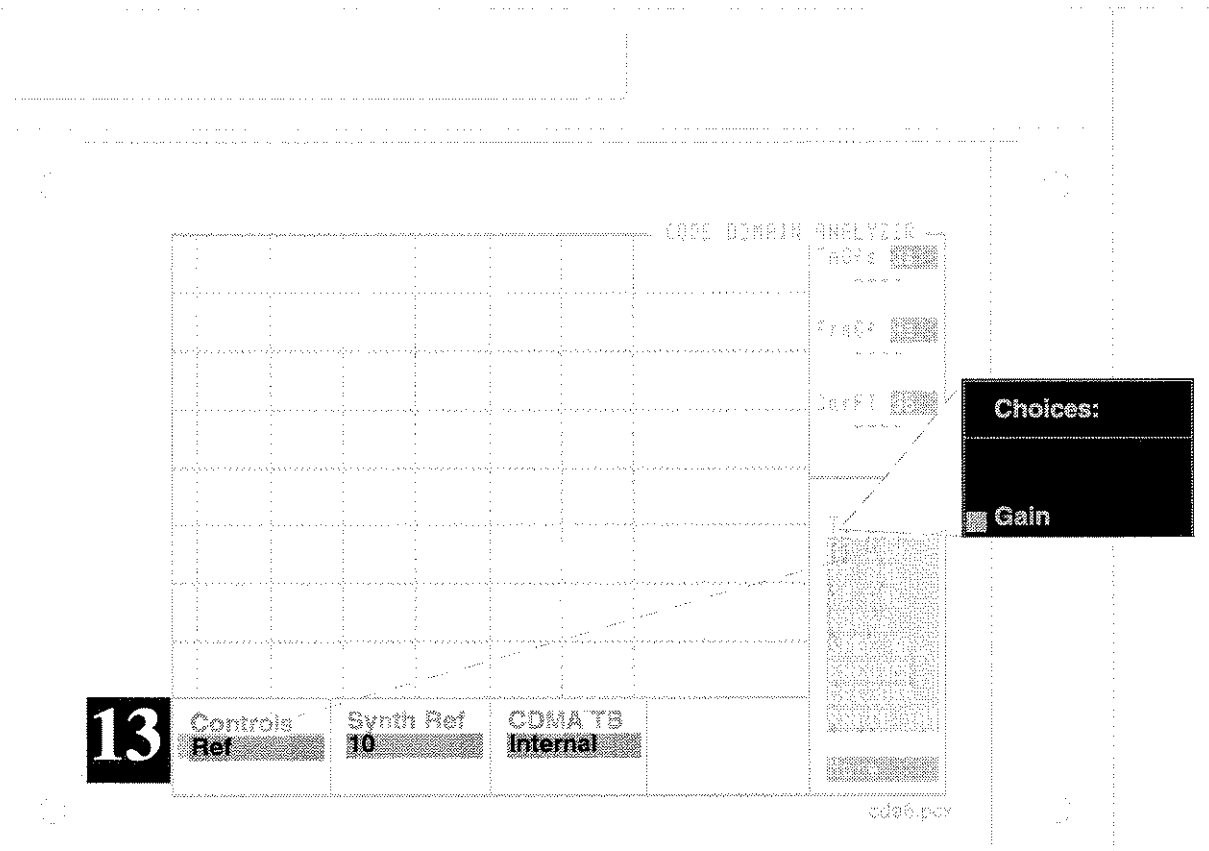

**Step 14** Adjust the **Gain** field until the **ADC fs** measurement is in the range of -1 to -10 dB.

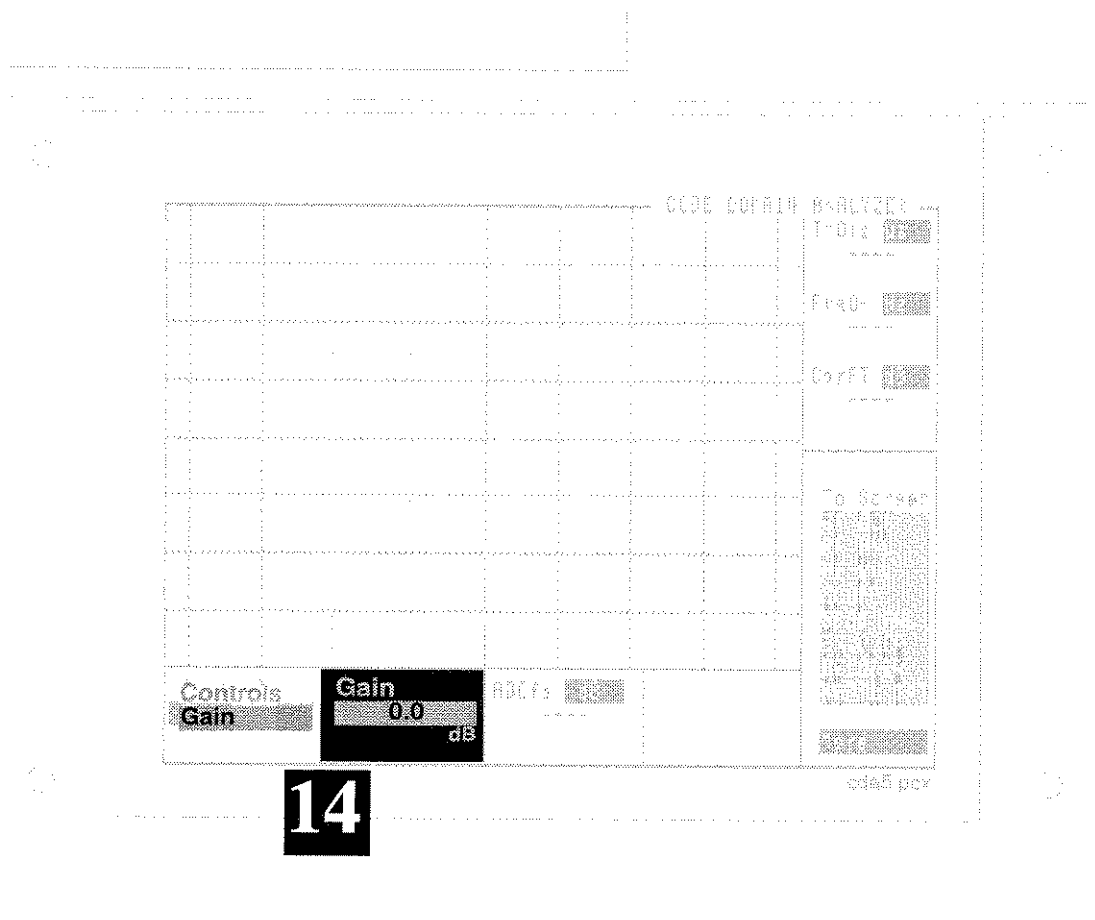

**Measurement Results**

The relative level of each of the 64 Walsh Channels is displayed. Use the **Marker Controls** to check the measurement value of an individual channel.

The Time Offset (**TmOfs**), Frequency Offset (**FrgOf**) and Carrier Feedthru (**CarFt**) of the entire 1.23 MHz signal are displayed in the upper-right corner of the screen. (These are the same values displayed when making a Rho measurement on the CDMA Analyzer screen.)

The first measurement may take several seconds, especially under non-ideal conditions. If no measurements are displayed, verify all instrument settings and connections. You can use the Test Set's Spectrum Analyzer to verify the presence of the 19.6608 MHz and CDMA carrier from your base station. For additional troubleshooting information, see **chapter 3, "Troubleshooting Measurement Problems"**

For further discussion about signal requirements for the SYNTH REF IN and EVEN SECOND/SYNC IN connectors, see **chapter 5, "Connectors, Indicators, and Miscellaneous Hardware"**

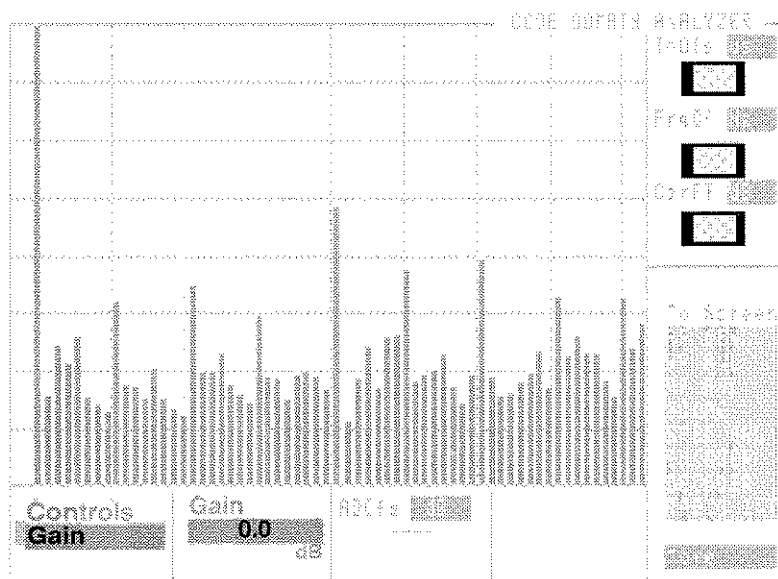

## Performance in Additive Noise (Receiver Test)

Receiver Performance in Additive Noise requires the CDMA Generator to be synchronized to the base station's even second clock. The PN Offset Index of the base station is entered to provide the proper time alignment for the generator.

To perform this test, the base station must be out of service to allow the CDMA Generator signal to be connected directly to the Receive A and B ports. This allows a precise generator level to be set at each input, and prevents unwanted signals from negatively affecting the measurements.

The Cellular Adapter's data buffer and calibrated noise sources are used to create the required test signal.

The Cellular Adapter cannot read back the receiver's Frame Error Rate (FER) during the test. The person performing the test must read this value from the base station or by some other means available.

The procedure on the following page uses a data rate of 9.6 kbps. For details about the steps in the procedure, see "**Explanation of Additive Noise Procedure**" on **page 74**.



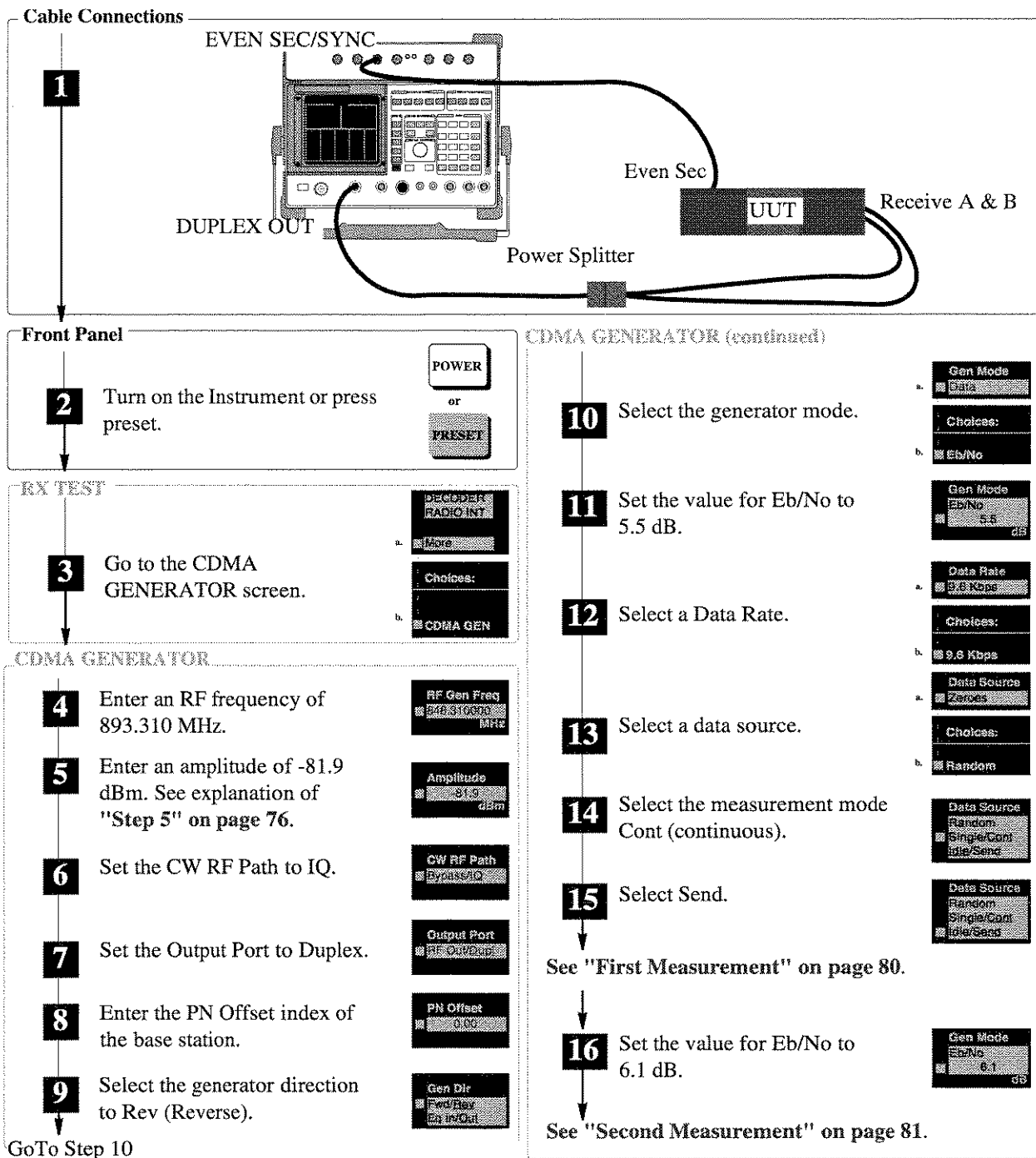

Figure 6 Receiver Performance in Additive Noise Measurement Procedure

### Explanation of Additive Noise Procedure

These explanations are intended to add detail about the steps required to perform a receiver performance in additive noise measurement. For the step by step instruction see "Receiver Performance in Additive Noise Measurement Procedure" on page 73.

#### Step 1

The even second clock of the base station provides the timing reference to generate CDMA signals from the Cellular Adapter. The power splitter provides a signal to both receiver inputs from the CDMA Generator.

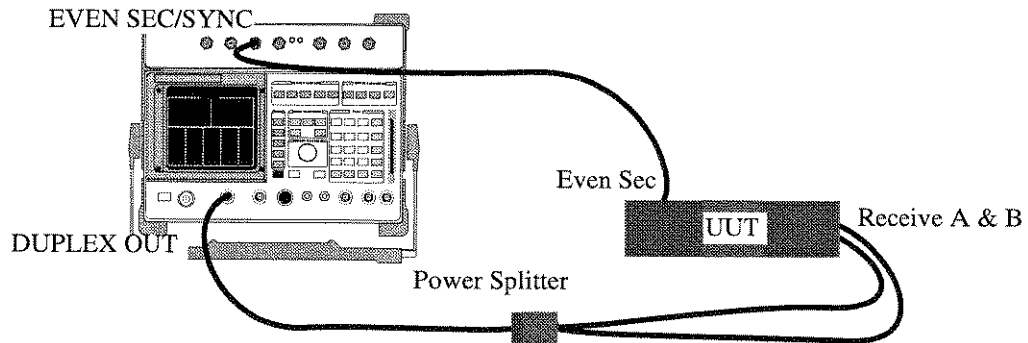

**Step 2** This sets the instrument to a known state. The **RX TEST** screen is displayed when ready.

**Step 3** Selecting the **More** field displays a list of screens to choose from, including all of the CDMA screens. Select **CDMA GEN** to access the generator.

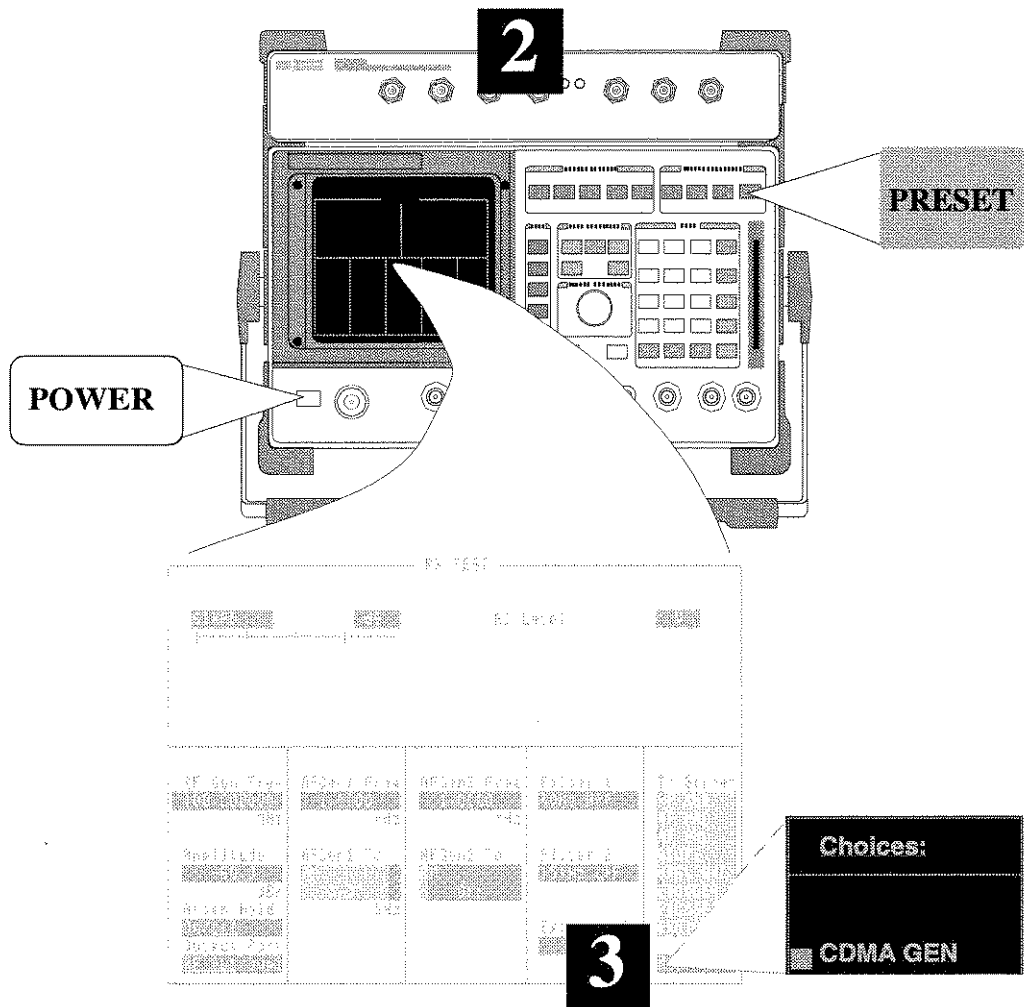

**Step 4** Enter your receiver's tune frequency into the **RF Gen Freq** field.

**Step 5** Enter the amplitude that will result in a level of -81.9 dBm at each of the receiver ports. The level should be the value of the **Amplitude** field minus the loss through the power splitter. For example; if you have 6 dB of loss through the splitter at each output, set the level to -75.9 dBm.

**AMPLITUDE CALIBRATION**

IS-97 standards specify a level of -84 dBm in a 1.23 MHz bandwidth for this measurement. However, the noise generator's level is normalized to a 2 MHz bandwidth signal. A correction factor is generated using the following formula:

$$\frac{10 \times \text{Log}\left(\frac{2\text{MHz}}{1.23\text{MHz}}\right) = 2.1\text{dB} : (-84\text{dBm} + 2.1\text{dB} = -81.9\text{dBm})$$

**Step 6** Setting the **CW RF Path** field to **IQ** enables IQ modulation.

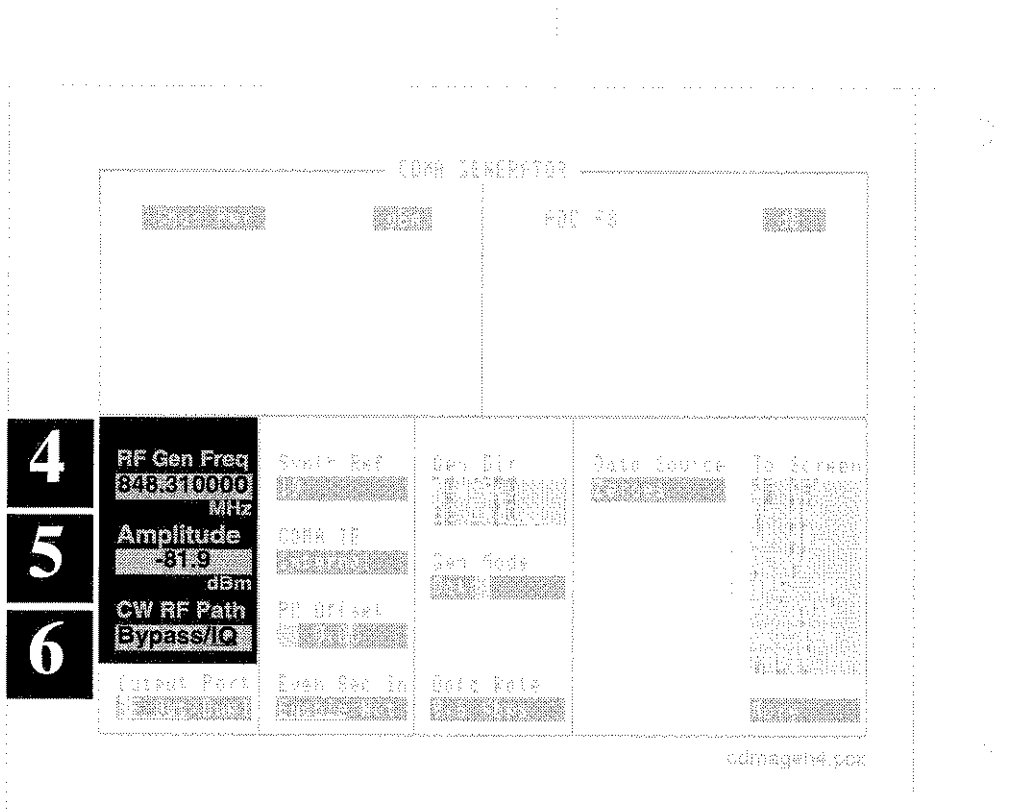

**Step 7** The **Output Port** is set to **Dup1** to use the DUPLEX OUT port.

**Step 8** The PN Sequence Offset Index of the base station is entered to time-align the start of the Cellular Adapter's CDMA signal to the receiver. After an even second pulse is received on the EVEN SECOND/SYNC IN port, the Cellular Adapter delays transmitting its signal to the receiver for the period derived from the PN Offset field's value (1 PN Offset = 64 chips = 52.08 microseconds).

**Step 9** The generator direction (**Gen Dir**) is set to **Reverse** to emulate a mobile.

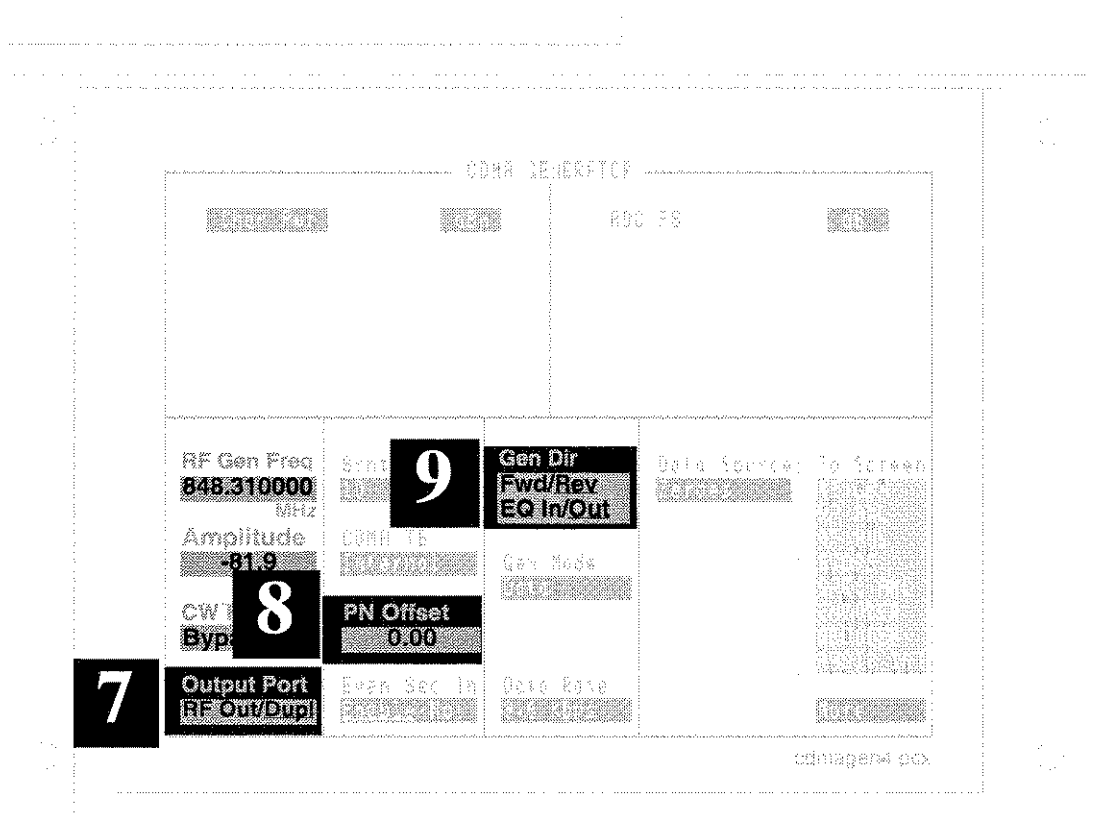

**Step 10** The **Gen Mode** determines the CDMA signal's content. Select  $E_b/N_0$  to create a combination of data and noise.

**Step 11** Setting the value of  $E_b/N_0$  to **5.5 dB** sets the ratio of the energy in the data to the energy in the noise.

**Step 12** Selecting **Data Rate** sets the data rate to rate set 1 (9600 kbps) or rate set 2 (14.4 kbps).

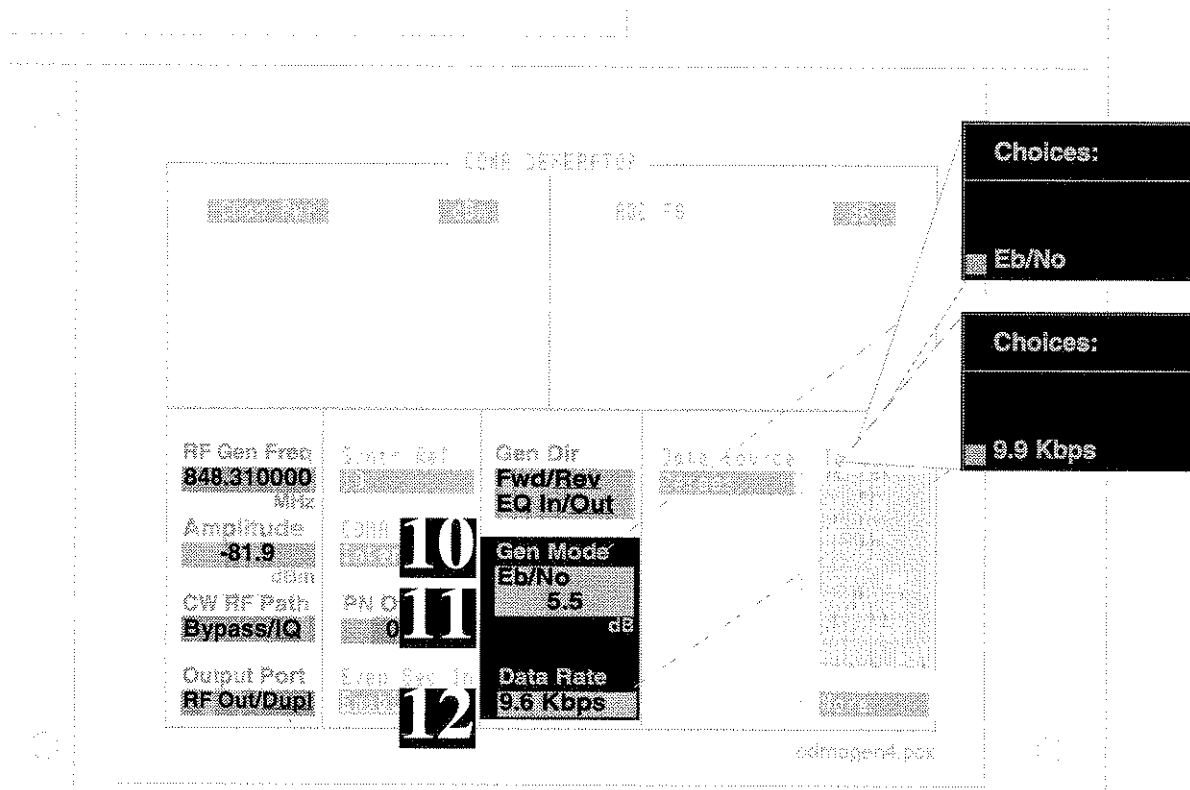

- Step 13** Selecting **Random** for the **Data Source** sets the generator to use 300 frames of random data.
- Step 14** Setting the **Data Source** to **Cont** causes a continuous, repeating output of the random data after **Send** is selected.
- Step 15** **Send** causes the generator to start sending. In this case, the generator continues to send until **Idle** or **Single** is selected.

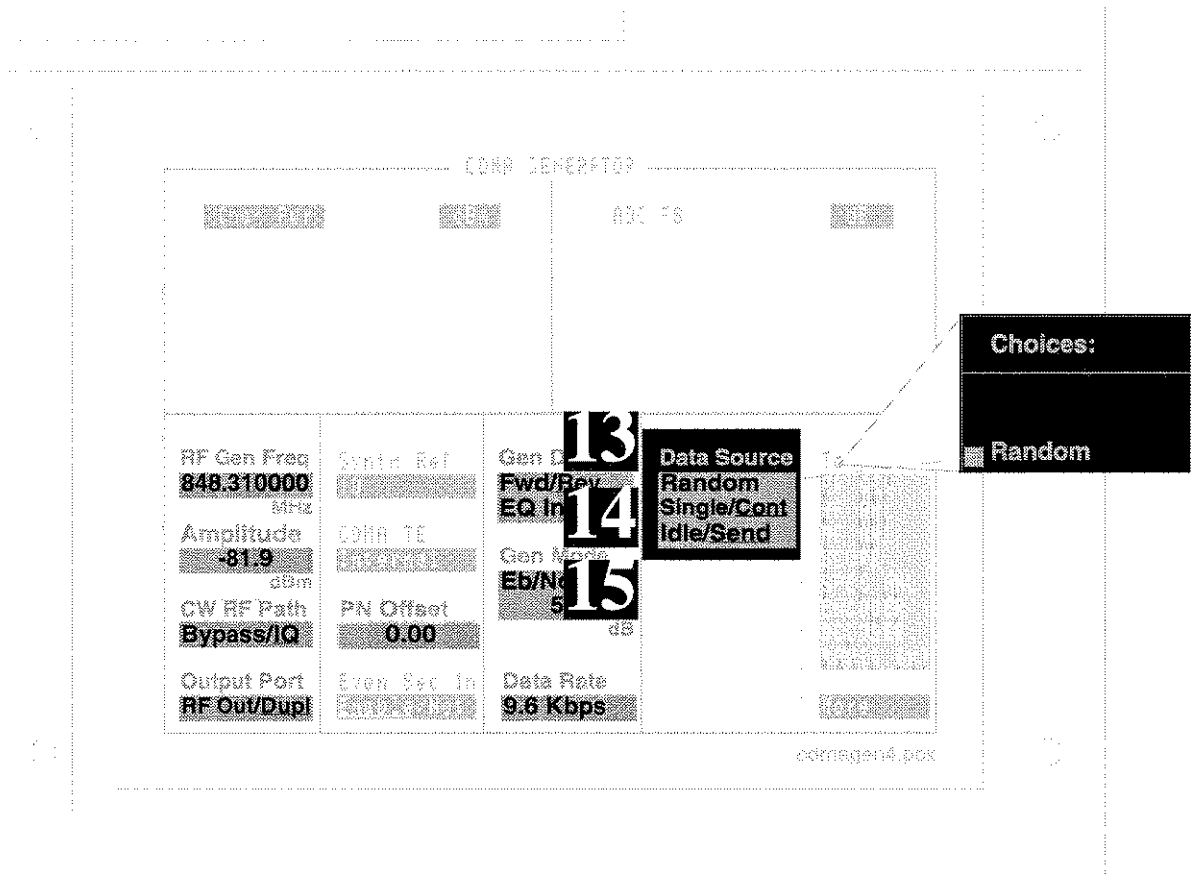

**First Measurement** Read the Frame Error Rate (FER) from your base station. *IS-97 standards specify an FER of no greater than 4.2% with 95% confidence at an  $E_b/N_o$  of 5.5 dB.*  
(Confidence Limits are discussed in section 12.8 of the IS-97 standards.)



**Step 17** Change the  $E_b/N_0$  setting to 6.1 dB.

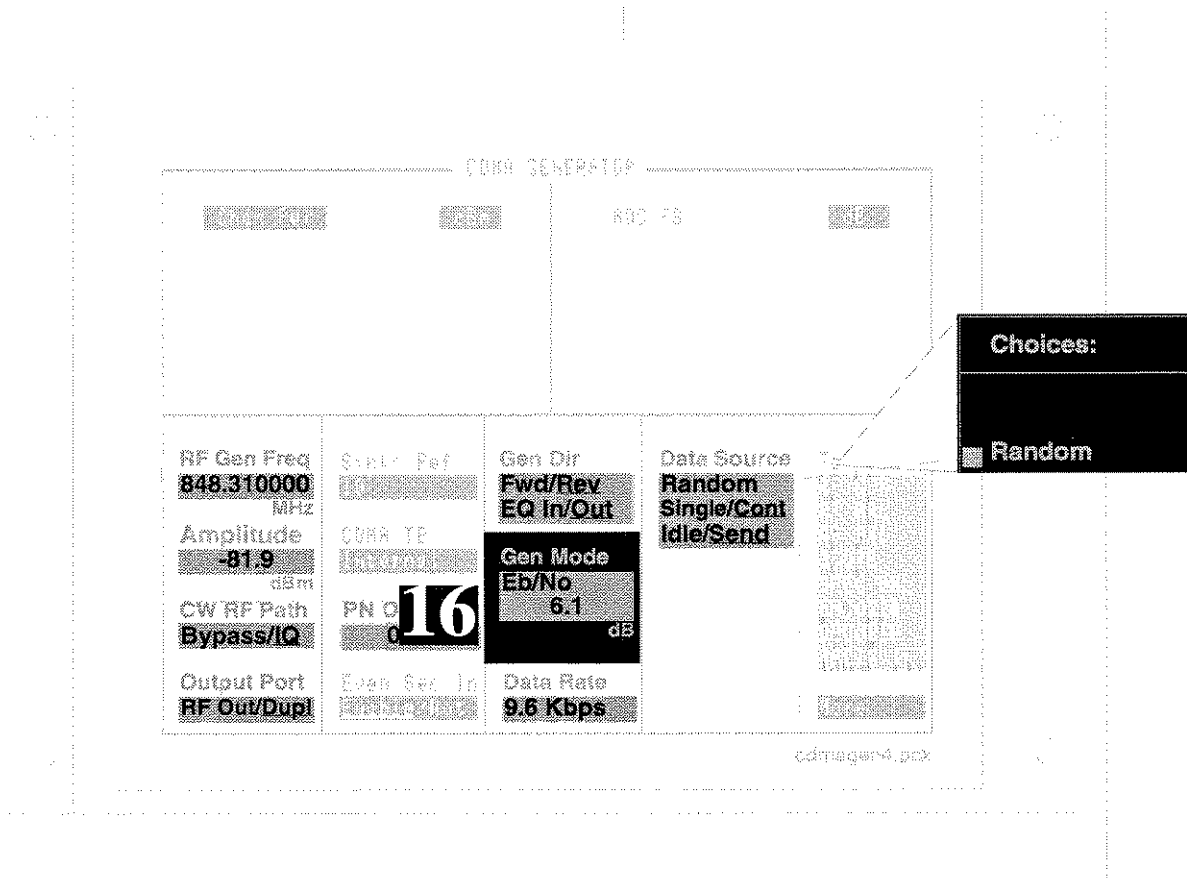

**Second Measurement**

Read the Frame Error Rate (FER) from your base station. *IS-97 standards specify an FER of no greater than 0.4% with 95% confidence at an  $E_b/N_0$  of 6.1 dB.*

## Receiver Sensitivity

Receiver Sensitivity requires the CDMA Generator to be synchronized to the base station's even second clock. The PN Offset Index of the base station is entered to provide the proper time alignment for the generator.

To perform this test, the base station must be out of service to allow the CDMA Generator signal to be connected directly to the Receive A and B ports. This allows a precise generator level to be set at each input, and prevents unwanted signals from negatively affecting the measurements.

The Cellular Adapter's data buffer is used to create the required test signal.

The Cellular Adapter cannot read back the receiver's Frame Error Rate (FER) during the test. The person performing the test must read this value from the base station or by some other means available.

For details about the steps in the procedure on the following page, see **"Explanation of Receiver Sensitivity Procedure"** on page 84.

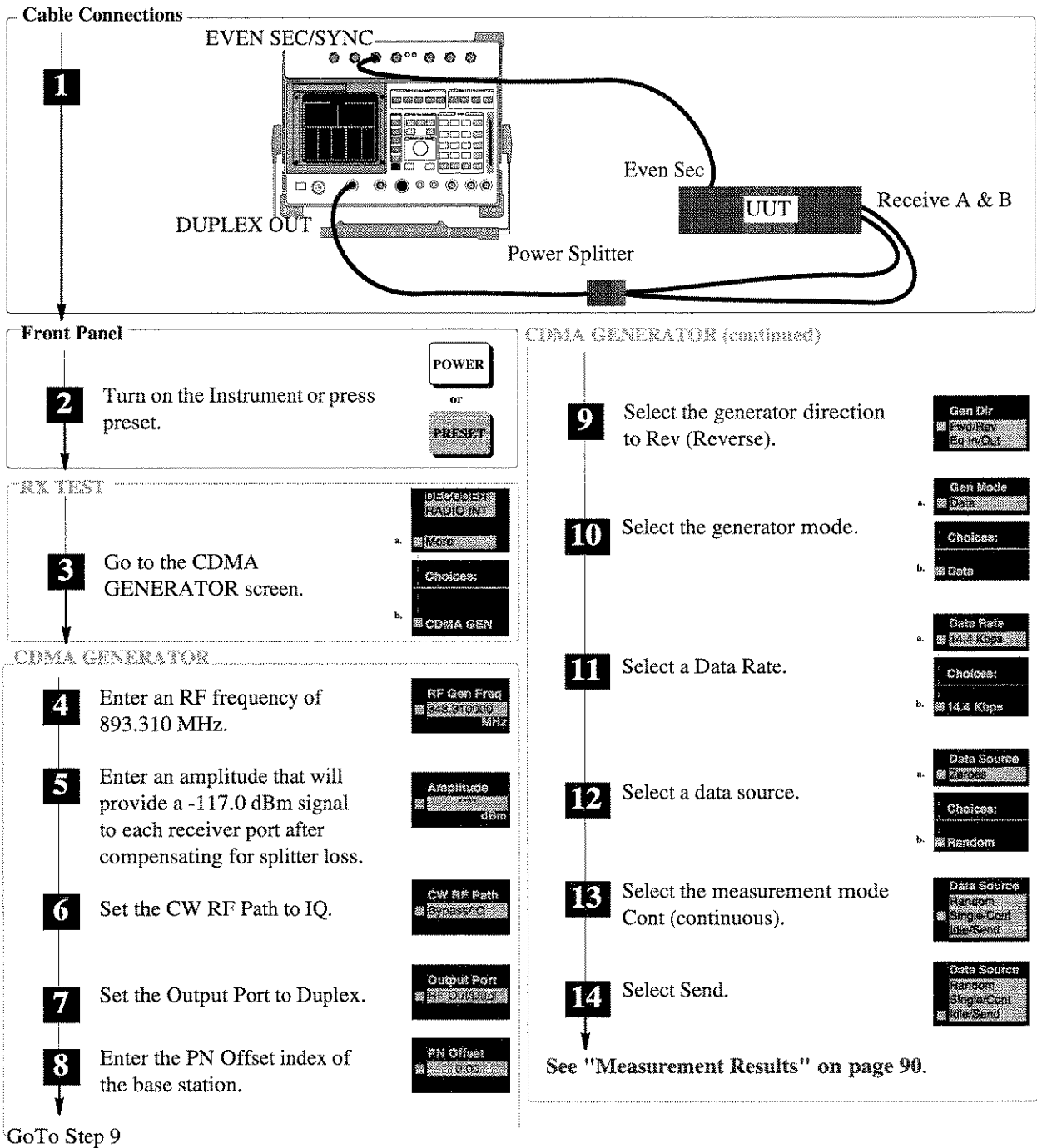

Figure 7 Receiver Sensitivity Measurement Procedure

### Explanation of Receiver Sensitivity Procedure

These explanations are intended to add detail about the steps required to perform a receiver sensitivity measurement. For the step by step instruction see "Receiver Sensitivity Measurement Procedure" on page 83.

#### Step 1

The even second clock of the base station provides the timing reference to generate CDMA signals from the Cellular Adapter. The power splitter provides a signal to both receiver inputs from the CDMA Generator.

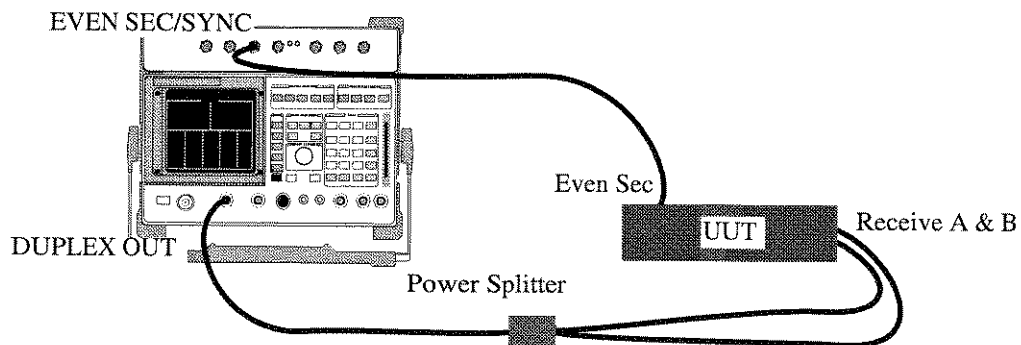

**Step 2** This sets the instrument to a known state. The **RX TEST** screen is displayed when ready.

**Step 3** Selecting the **More** field displays a list of screens to choose from, including all of the CDMA screens. Select **CDMA GEN** to access the generator.

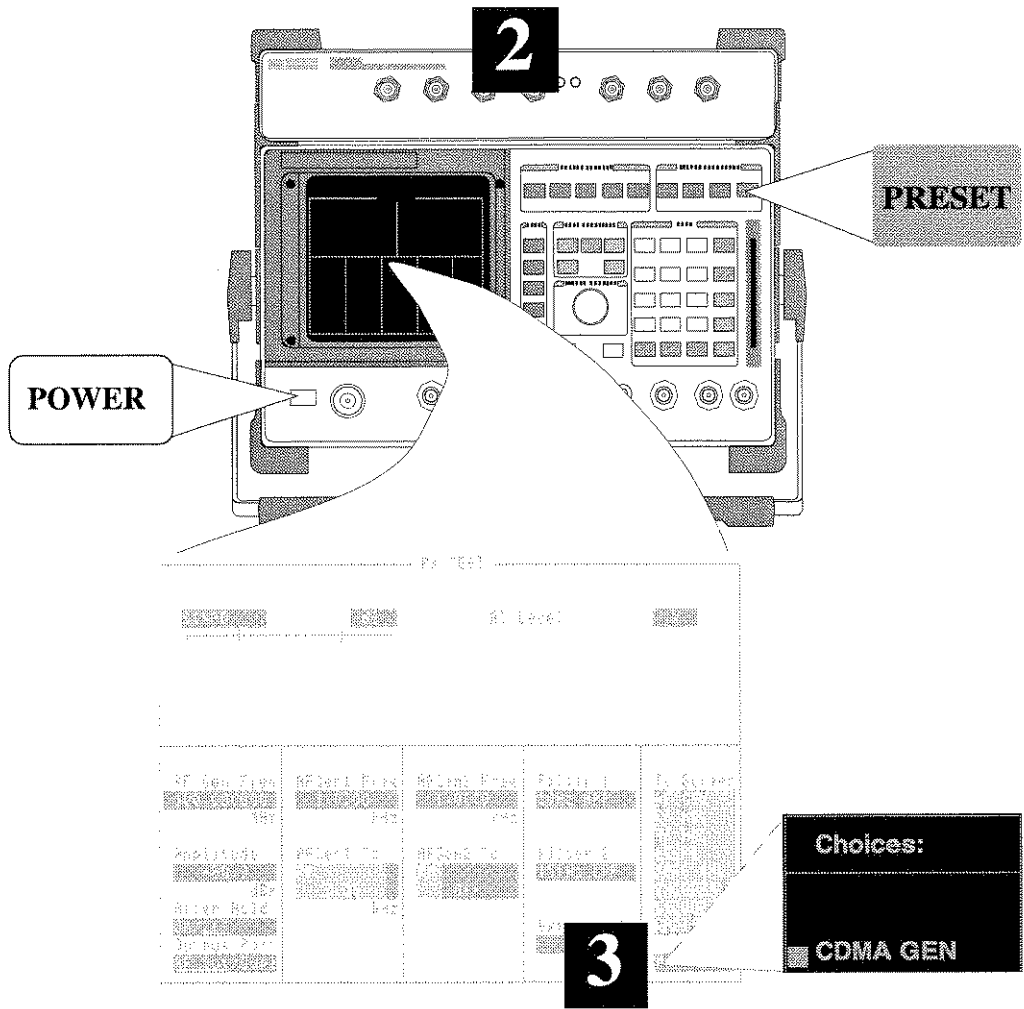

- Step 4** Enter your receiver's tune frequency into the **RF Gen Freq** field.
- Step 5** Set the generator **Amplitude** to a level that will provide a -117 dBm signal to each receiver port after compensating for the loss through the splitter.
- Step 6** Setting the **CW RF Path** field to **IQ** enables IQ modulation.

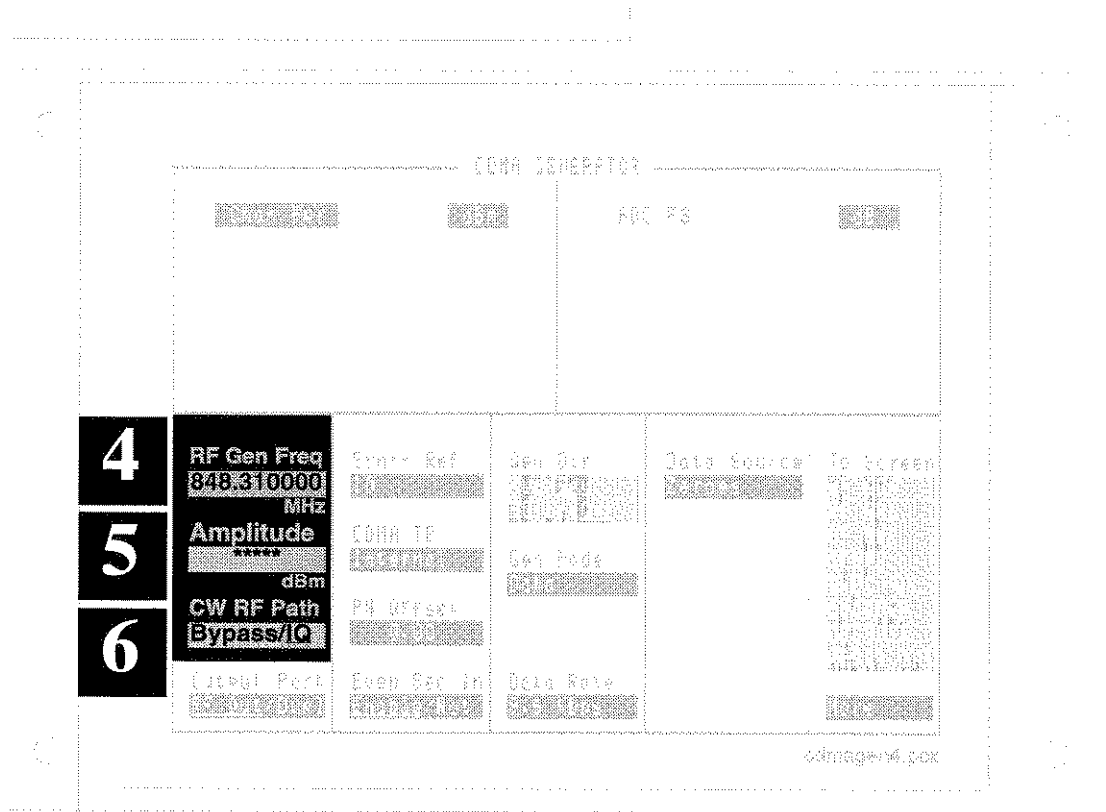

**Step 7** The **Output Port** is set to **Dup1** to use the DUPLEX OUT port.

**Step 8** The PN Sequence Offset Index of the base station is entered to time-align the start of the Cellular Adapter's CDMA signal to the receiver. After an even second pulse is received on the EVEN SECOND/SYNC IN port, the Cellular Adapter delays transmitting its signal to the receiver for the period derived from the PN Offset field's value (1 PN Offset = 64 chips = 52.08 microseconds).

**Step 9** The generator direction (**Gen Dir**) is set to **Reverse** to imitate a mobile.

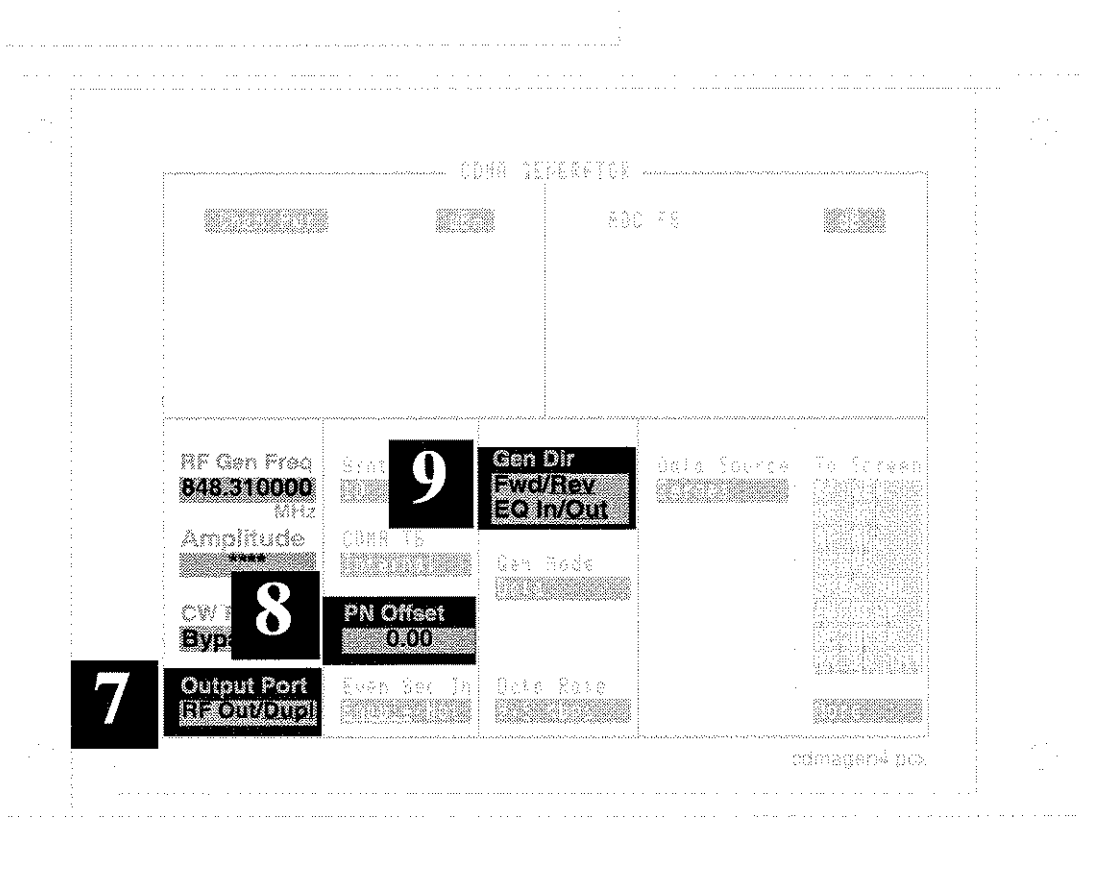

**Step 10** The **Gen Mode** determines the CDMA signal's content; select **Data**.

**Step 11** Select 9.6 kbps or 14.4 kbps, depending on the vocoder used in your receiver.

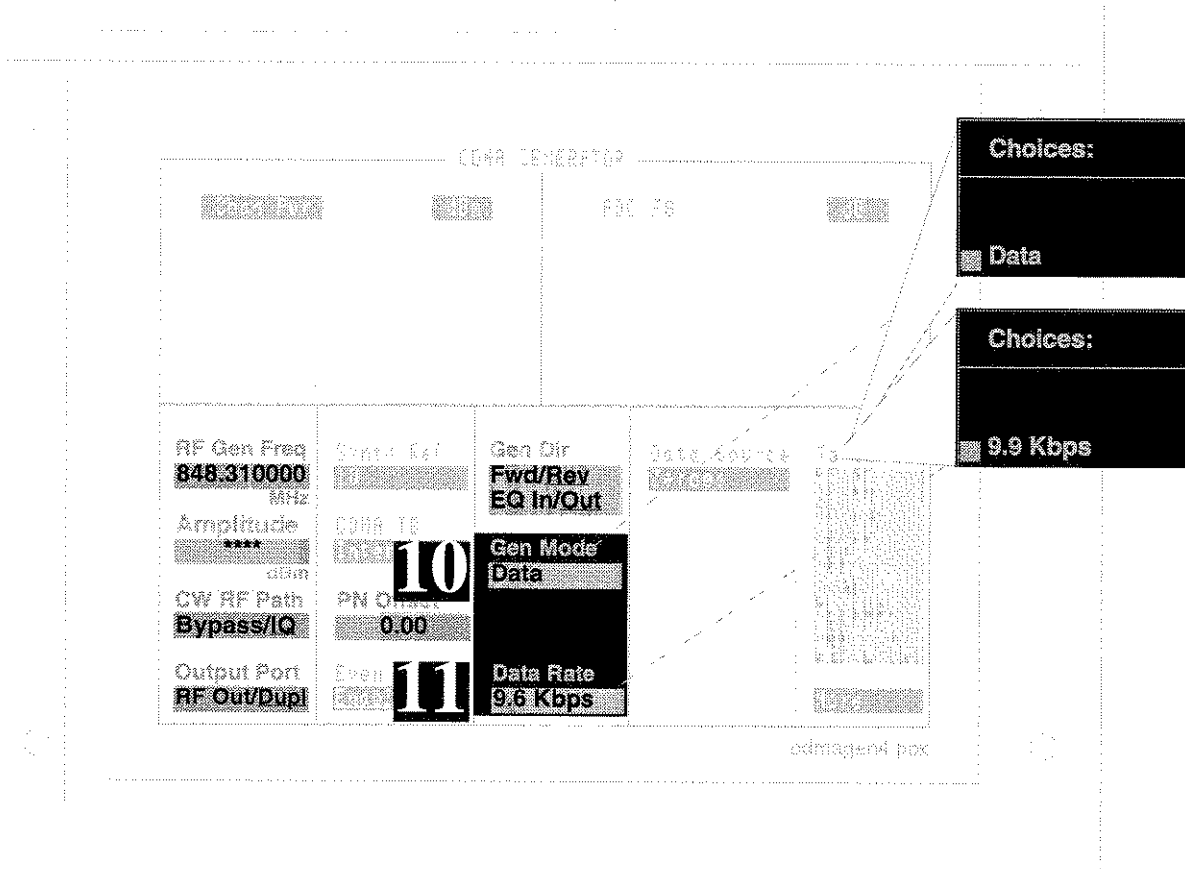



**Step 12** Selecting **Random** for the **Data Source** sets the generator to use pre-loaded error-free data.

**Step 13** Setting the **Data Source** to **Cont** causes a continuous, repeating output of the random data after **Send** is selected.

**Step 14** **Send** causes the generator to start sending. In this case, the generator continues to send until **Idle** or **Single** is selected.

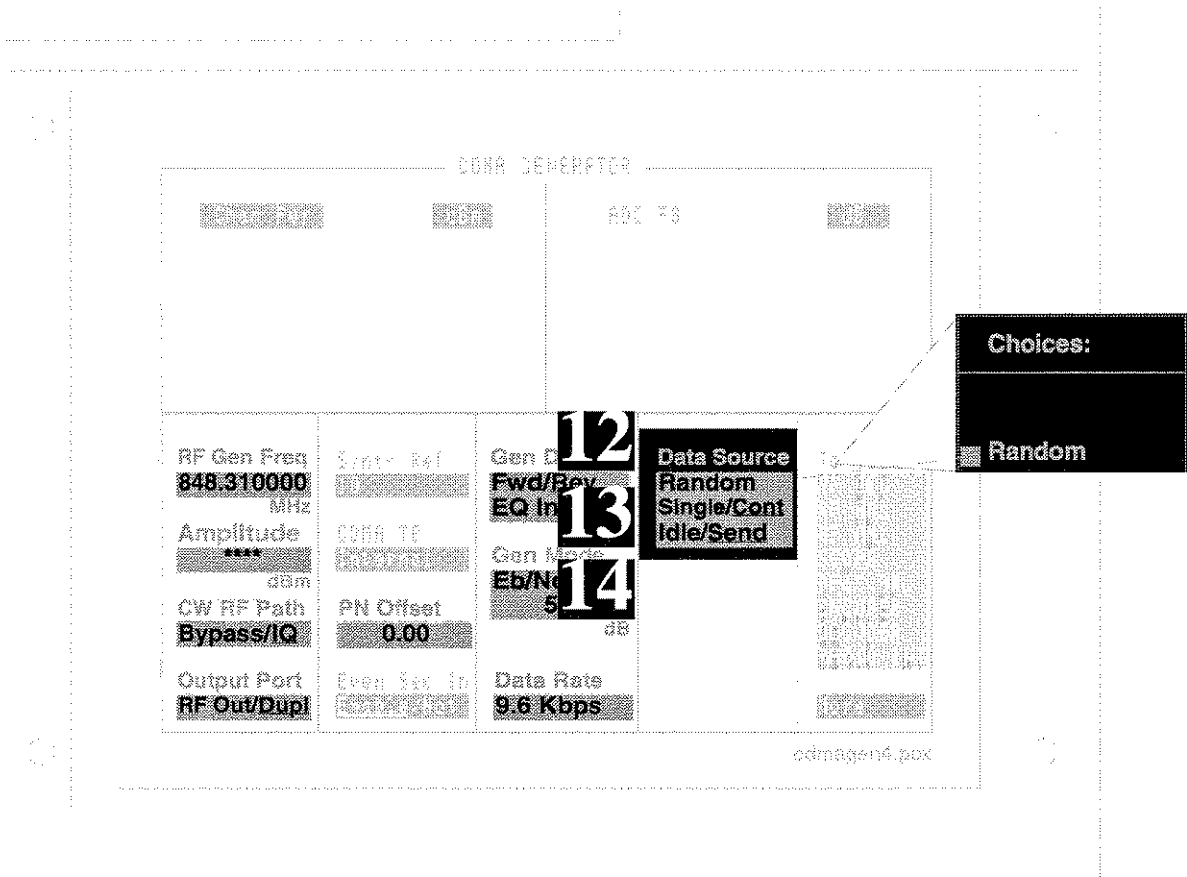

**Measurement  
Results**

Read the Frame Error Rate (FER) from your base station. *IS-97 standards specify an FER of 1% or less with 95% confidence at a signal level of -117 dBm.* (Confidence Limits are discussed in section 12.8 of the IS-97 standards.)

If the Frame Error Rate is much higher than expected, try adjusting the **PN Offset** value in increments of 0.015625 (1 chip) to see if there is a timing problem. To set the increments, position the cursor in front of the PN Offset field and press INCR SET, .015625, ENTER. Use the CURSOR CONTROL knob to change the PN Offset value.

---

## Troubleshooting Measurement Problems

This chapter provides troubleshooting information when making measurements on the CDMA Analyzer or Code Domain Analyzer screens. The CDMA Analyzer and Code Domain Analyzer screens use the same instrument setups to make measurements. Therefore, use the following procedures to make CDMA Analyzer measurements first, then access the Code Domain Analyzer to display code domain results.

---

**REAR PANEL  
CABLING**

Four SMC-ended coax cables are connected between the Cellular Adapter and the Test Set during installation. These cables, along with the large I/O Control cable, must be connected properly for any measurements to be made. For an illustration of how these cables are connected, see **chapter 10, "Installation"** The BNC cable connecting the timebases may be changed as needed for your measurement setup. The setup is properly configured when the REF UNLOCK indicator on the Cellular Adapter is not lit.

---

---

## Verifying the Presence of Your Signal

The minimum signal level for making Rho, EVM, Channel Power, and Code Domain measurements is: -10 dBm when using the RF IN/OUT port, and -46 dBm when using the ANT IN port. Average Power measurements require a minimum level of 0 dBm at the RF/IN OUT port (the ANT IN port cannot be used for measuring Average Power).

### Looking at Your Signal With the Spectrum Analyzer

1. Turn the Test Set Off and On or press PRESET.
2. Connect your signal to the RF IN/OUT port on the Test Set.
3. Select **SPEC ANL** from the To Screen menu to access the Spectrum analyzer.
4. Enter the center frequency of your signal in the **Center Freq** field.
5. Set the **Span** field to 4.0 MHz.
6. Adjust the **Ref Level** field until the CDMA spectrum can be seen to rise above the noise floor, but does not touch the top of the screen. (With a level of -46 dBm at the RF IN/OUT port you will see the characteristic CDMA signal rise about one-half of a division above the noise level.)
7. Select **Main** to access the **Auxiliary** controls.
8. Change the setting to **Avg 5** to provide measurement averaging.
9. Read the signal level (**Lvl dBm**) on the right side of the screen. The level will vary as the marker tracks amplitude variations in the signal.

Power in a CDMA signal is defined for a 1.23 MHz bandwidth. The Spectrum Analyzer, in this case, measures with a 30 kHz resolution bandwidth. This results in a 16 dBm difference between the total CDMA power and the Spectrum Analyzer's reading at the center of the CDMA signal.

The screen image on the following page is an example of what you should see with an input level of 0 dBm.

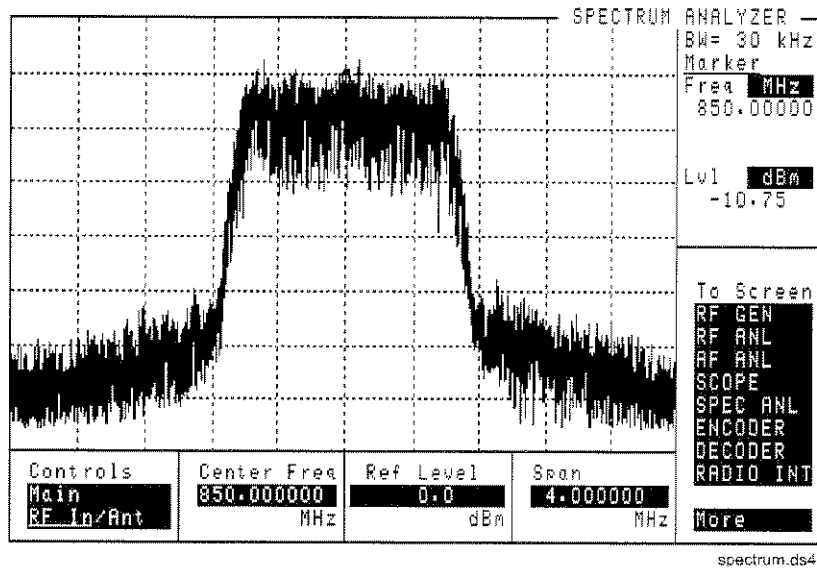

Figure 8

A 0 dBm CDMA Signal Measured With the Test Set's Spectrum Analyzer

**Isolating  
 Measurement  
 Problems**

*After verifying an acceptable signal level using the spectrum analyzer, use this information to determine why a measurement isn't being made.*

#### No Average Power Measurement

1. Verify that your signal is connected to the Test Set's RF IN/OUT port.
2. Verify that the Test Set's rear-panel DET OUT port is connected properly to the Cellular Adapter's AUX DSP IN port.
3. Set the **Analyzer** field (CDMA ANALYZER screen) to **Cont** to make continuous measurements.
4. Verify that the **Tune Freq** field is set to your CDMA channel frequency.
5. Verify the **ADC FS** level is between -1 and -15 dB.
  - If the level is too low, make sure the **Pwr Gain** field is set to **Auto**.
  - If the level is still too low, but the **Pwr Gain** is not set to 72 dB, change the setting from **Auto** to **Hold** and manually increase the gain.

#### No Rho, EVM, Channel Power, or Code Domain Measurements

1. Verify that your signal is connected to the **Input Port** selected on the CDMA ANALYZER screen.
2. Verify that the REF UNLOCK indicator is not lit.
3. Verify the frequency and level of the signal connected to the SYNTH REF port using the Test Set's Spectrum Analyzer. This level should be in the range of 0 to +23 dBm.
4. Verify these CDMA ANALYZER screen settings:
  - **Tune Freq** is set to the CDMA signal center frequency.
  - **Input Port** indicates the port your signal is connected to.
  - **PN Offset** is correct for the base station being measured.
  - **Anl Special** is set to 0.
  - **Anl Dir** is set to **Fwd** (to analyze a base station's signal).
  - **Analyzer** is set to **Cont**.
5. Verify that an acceptable Even Second clock signal is being used:
  1. Set the **Qual Event** field to **External**.
  2. Connect your Even Second Clock signal to the front-panel TRIGGER/QUALIFIER IN port.
  3. Set the **Trig Event** field to 27ms.

Measurements should be triggered every two seconds if the Even Second signal is present and at an acceptable level.

6. If measurements are still not being displayed, the CDMA Analyzer has a triggering problem associated with the **Qual Event** and **Trig Event** settings. For more information, see "Solving Triggering Problems" on page 96.

## Solving Triggering Problems

The CDMA Cellular Adapter provides many different possible triggering modes. The following procedure will verify that a valid trigger mode is selected.

1. Make sure the trigger source has a fixed timing relationship with the pilot PN sequence that the CDMA Cellular Adapter is measuring.

The trigger source can be generated by the Cellular Adapter (internal) or externally generated. The base station's pilot PN sequence is presumed to be closely aligned with the even second signal used to synchronize the CDMA Cellular Adapter's frame clocks. To use one of the Cellular Adapter's frame clocks as a trigger source, select one of the following **Trig Event** field choices:

- 27 millisecond
- 80 millisecond
- 2 second

If the trigger source you have chosen is from an external source, connect it to the TRIGGER/QUALIFIER IN front-panel connector. Select **External** in the **Qual Event** field, and **Delay** in the field. Adjust **Delay** if necessary.

2. Select a trigger qualifier (optional). A trigger qualifier of **None** can be chosen if a trigger qualifier is not necessary.

Trigger qualifiers enable triggering when a selected qualifier occurs.

Example: **Ampl Lo**, **Ampl Mid**, and **Ampl Hi** will not allow a trigger event until the received signal amplitude rises above a specified level. For a description of levels, see **chapter 4, "CDMA Screens Descriptions"**

3. Select a delay (optional). If you want the trigger event to occur after a period of time has elapsed, select **Delay** in the **Trig Event** field. The delay period begins with the trigger qualifier event.



### Example of Trigger Event Timing Problems

The following example shows data blocks including a portion of the downconverted IF waveform not replicated by the reference signal.

To correct this problem, the trigger delay should be adjusted or a different trigger source should be used. In the upper example, the delay should be reduced. In the lower example, the delay should be increased.

For an explanation of data block acquisition and the correlation process, see "DSP Analyzer Trigger Event Timing" on page 197.

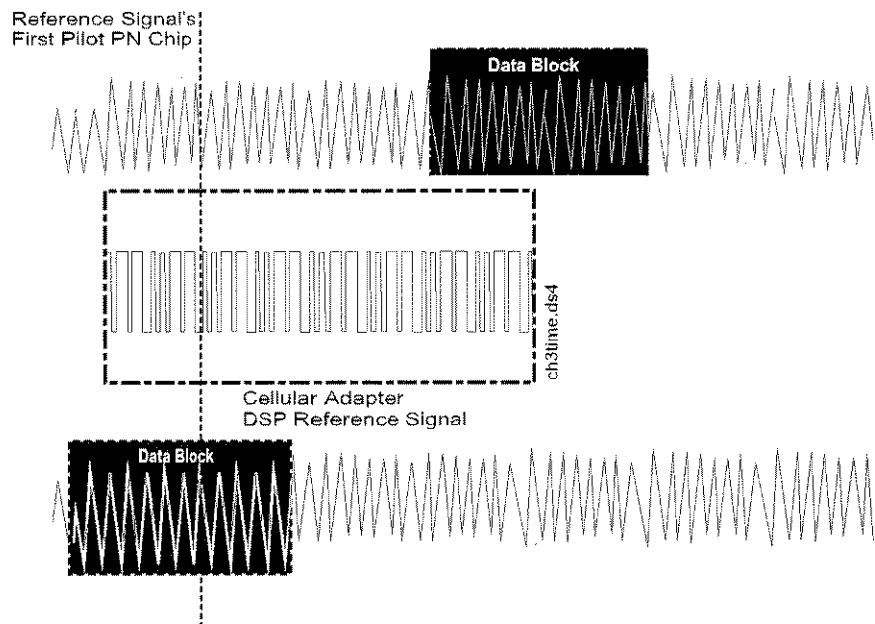

**NOTE:**

The later the trigger event occurs relative to the start of the received IF pilot PN sequence, the more calculations the DSP analyzer has to make in order to obtain correlation and provide measurement results. When the trigger event delay is excessive, you will notice that measurements are slowed. Performing the RF Loopback measurement in will give you an idea of how rapidly measurements should re-display; see chapter 1, "Get Started with a Simple CDMA Test"

Chapter 3, Troubleshooting Measurement Problems  
**Verifying the Presence of Your Signal**

---

## CDMA Screens Descriptions

## CDMA Analyzer Screen

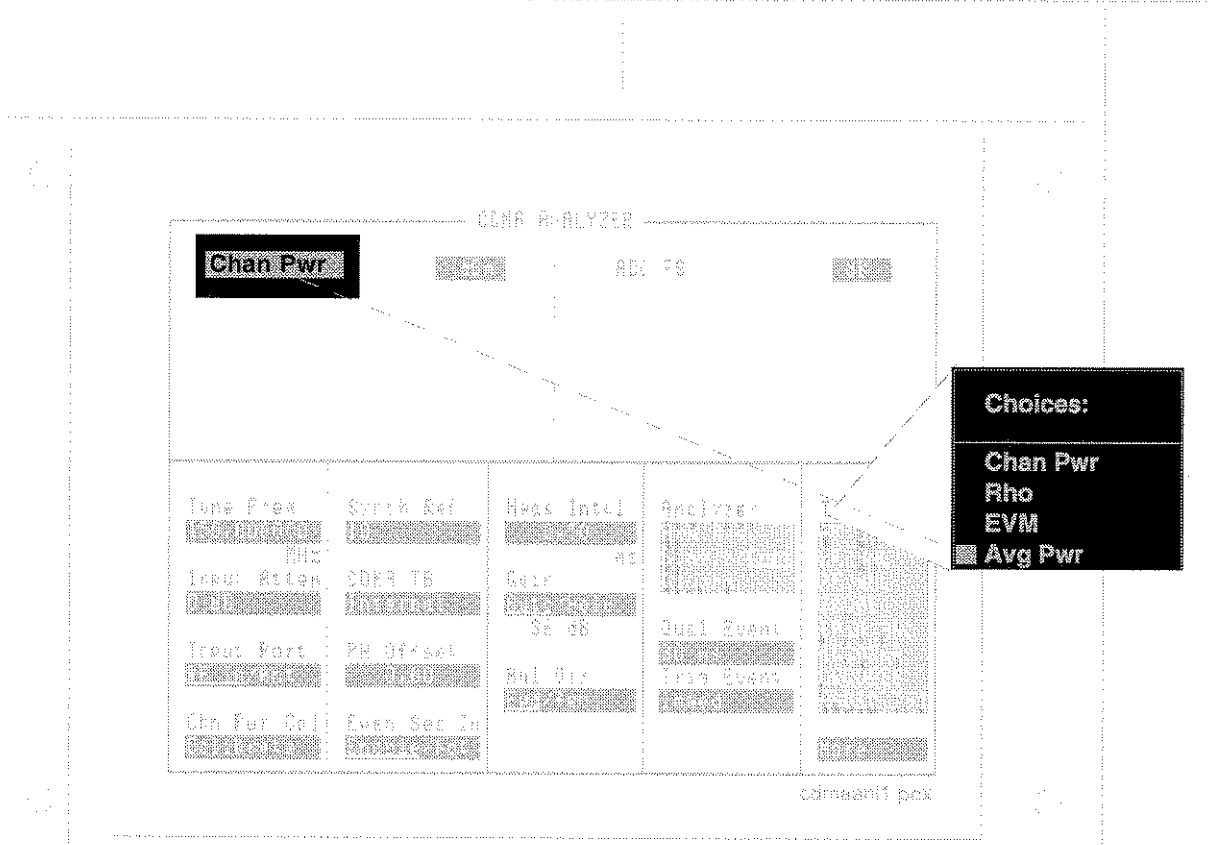

## MEASUREMENT TYPES

A list of available measurement choices is displayed when the top-left field of this screen is selected. The default measurement is **Avg Pwr**.

### Average Power

**Avg Pwr** displays the average power level of the signal connected to the RF IN/OUT port. The units can be changed (watts, volts, or dBm) by positioning the cursor in front of the current units and then pressing the desired units key. (See **Input Port**.)

- **ADC FS** is displayed when Average Power is measured. ADC FS indicates how close the measured power level is to the maximum allowed input level at the RF IN/OUT port for a particular **Pwr Gain** setting. Changes to ADC FS can be made by altering the **Pwr Gain** field setting and by altering the signal level into the RF IN/OUT port (refer to the diagram below). ADC FS should be between  $-1.0$  and  $-10$  dB when the is set to **Auto**, and can be manually set up to  $-0.5$  dB when set to **Hold**. The measurement will be aborted if ADC FS goes above  $-0.5$  dB. Measurement accuracy may be degraded if ADC FS goes below  $-10$  dB..

#### ADC FS FOR OTHER MEASUREMENTS:

The ADC FS level used for Average Power is not the same value used for making correlated measurements (Rho, EVM, Channel Power, and Code Domain). (For more information, see **ADCfs** field description, on page 130.

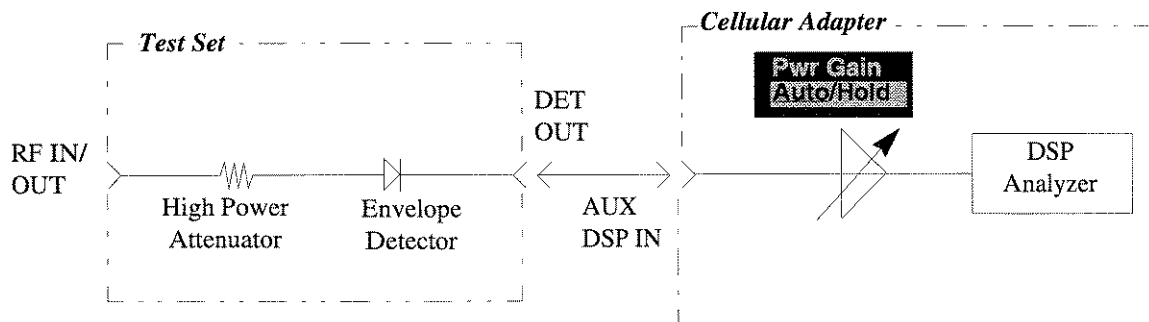

## Rho

Rho is a measure of CDMA waveform quality. The number returned in this measurement indicates how well the measured signal correlates with an ideal reference waveform, with a value of 1 indicating perfect correlation. The CDMA standard specifies 0.912 as the minimum accepted performance for CDMA base stations.

Three additional measurements are displayed when measuring Rho:

- **transmitter time offset** indicates how well your transmitter's signal is time-aligned to system time. The displayed value takes into account the PN Sequence Offset Index of your transmitter that is entered on the CDMA ANALYZER screen.
- **carrier frequency error** is the difference between your transmitter's actual center frequency and the frequency you enter in the **Tune Freq** field.
- **carrier feedthrough** indicates how well the IQ modulator of your transmitter is performing.

This diagram shows the time relationship of the received data block and the internal reference signal at the time index of peak correlation for three different time offsets.

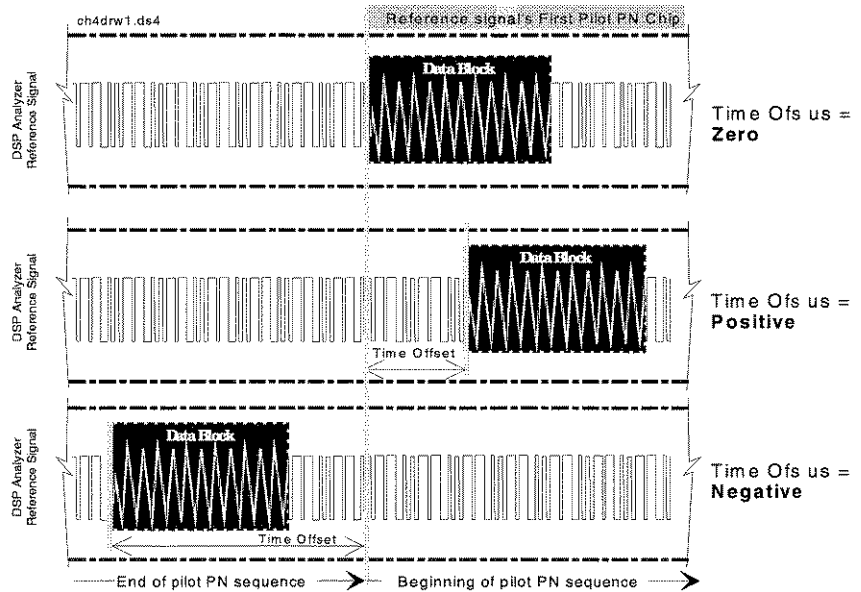

The first example is a measurement with a time offset of zero. The beginning of the received data block aligns with the first pilot PN chip of the reference signal. Zero time offset indicates that the trigger event to the CDMA Analyzer coincided with the arrival of the base station signal's first pilot PN chip.

When the base station's signal is delayed relative to the trigger event, time offset will be a positive value. The second example is a measurement with a positive time offset. The beginning of the data block will align with a portion of the reference signal toward the end of a pilot PN sequence. This indicates that the trigger event to the CDMA Analyzer occurred when the base station was still transmitting a pilot PN sequence prior to the first pilot PN chip of the expected sequence.

When the base station's signal is early relative to the trigger event, time offset will be a negative value. The third example is a measurement with a negative time offset. The beginning of the data block will align with a portion of the reference signal before the first pilot PN chip. This indicates that the trigger event to the CDMA Analyzer occurred after arrival of the base station signal's first pilot PN chip.

**EVM (Error Vector Magnitude)**

EVM is a measurement of the accuracy of the phase and amplitude of the QPSK (Quadrature Phase Shift Keying) or Offset QPSK (OQPSK) modulation. Expressed as a percentage, it is the RMS magnitude value of the error vector which connects the ideal signal phasor to a measured, signal phasor at the detection decision points.

The magnitude of this error vector represents the “error” between the ideal signal and the measured signal.

As part of the measurement, the signal is corrected for clock delay, carrier frequency, carrier phase, and amplitude scaling.

Two other measurements are also displayed when EVM is selected:

- **Magnitude Error** is the difference in the RMS magnitude value (in percent) between the ideal signal phasor and the compensated, measured signal phasor at the detected decision points.
- **Phase Error** is the RMS value of the difference in phase (degrees) between the ideal signal phasor and the compensated, measured signal phasor at the detection decision points.

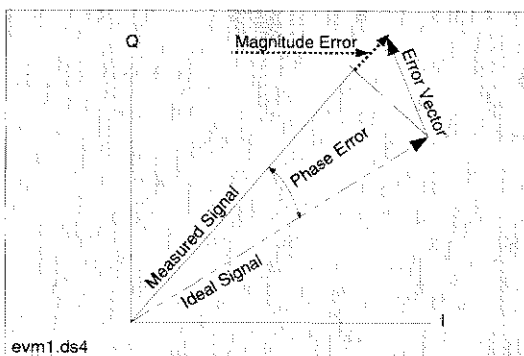

**Channel Power**

**Channel Pwr** is the absolute power level of the RF signal in a 1.23 MHz bandwidth centered around the **Tune Frequency** setting. This measurement must be calibrated using the **Chan Pwr Cal** field each time the **Tune Frequency** is changed.



**CONTROL FIELDS**

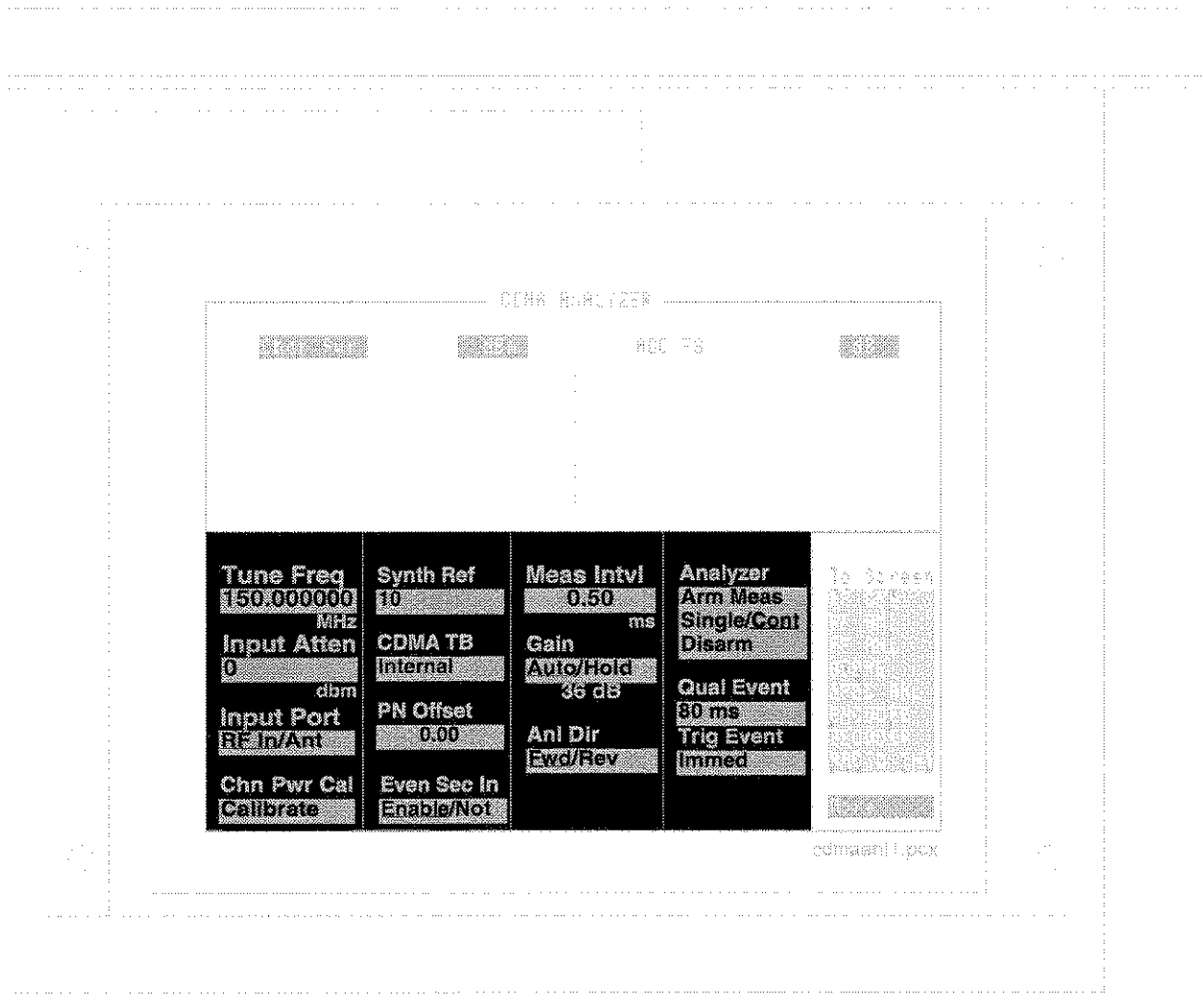

## Analyzer

The **Analyzer** field controls three functions:

- **Arm Meas** arms the CDMA analyzer. The CDMA analyzer needs to be armed only when **Single** (see below) is selected.
- **Single/Cont** selects between “single” measurements and “continuous” measurements.
  - When **Single** is chosen, you must arm each measurement by selecting the **Arm Meas** field (see above).
  - When **Cont** (continuous) is chosen, measurements are automatically armed.

The default selection is **Cont**.

---

### HP-IB OPERATION

The default triggering mode for HP-IB operation is **Continuous**. To specify single triggering using HP-IB, you need to use the **TRIGger:MODE:RETrigger SING** command. After issuing this command, the **Analyzer** field will still indicate **Cont** unless you issue the command **CAN:TRIG:STAT'SINGLE'** to change the field to **Single**. Refer to the Test Set's Programmer's Guide.

- 
- **Disarm** disarms the CDMA analyzer during **Single** operation. To stop continuous measurements, select **Single**. Selecting **Disarm** does not prevent the analyzer from being re-armed during continuous measurements

## Anl Dir

This field selects the type of signal to analyze.

- **Fwd** sets the analyzer to look for base station transmitter data (forward link).
- **Rev** sets the analyzer to look for mobile transmitter data (reverse link).

Default selection: **Fwd**

This field is replaced by the **Pwr Zero** field when making an Average Power measurement (which does not use on this setting).

## Anl Special

Analyzer Special modes change how IQ modulated signals are analyzed and generated by the Cellular Adapter.

- 0 sets the CDMA Generator and CDMA Analyzer to create and analyze signals per the IS-95 standards (standard rotation).
- 1 sets the Cellular Adapter to use reverse rotation for I and Q signals; opposite to the direction specified in the IS-95 standards. In this mode, the CDMA Generator creates reverse rotation IQ signals and the CDMA Analyzer expects reverse rotation IQ signals.
- 2 sets the CDMA Generator to create standard rotation IQ signals, and sets the CDMA Analyzer to expect reverse rotation IQ signals.
- 3 sets the CDMA Generator to create reverse rotation IQ signals, and sets the CDMA Analyzer to expect standard rotation IQ signals.

## CDMA TB

This field selects the reference frequency for the CDMA reference phase-locked-loop. This field is available on all CDMA screens; changing the value on one screen affects this value on all screens. For more information, see "Cellular Adapter Connector Block Diagram" on page 112.

**Internal** locks the internal CDMA frame clocks to the RF Synthesizer's reference.

All other choices require an external signal connected to the CDMA TIMEBASE IN connector. The REF UNLOCK indicator on the front panel is lit when the time base is not able to phase-lock to the selected reference. The frequency of this external signal must be one of the frequencies listed below (in MHz).

- 1
- 1.2288
- 2
- 2.4576
- 4.9152
- 5
- 9.8304
- 10
- 15
- 19.6608
- **Internal**

Default selection: **Internal**.

### Even Sec In

This field controls the internal connection of the EVEN SECOND/SYNC IN connector to the CDMA analyzer. This field is also provided on the CDMA GENERATOR screen.

- **Enable** When this mode is selected, signals applied to the EVEN SECOND IN/ SYNC IN synchronize the Cellular Adapter's timing circuits.
- **Not** When this mode is selected, input signals applied to the EVEN SECOND IN/ SYNC IN are ignored. This mode may be useful when signals other than an even-second clock are used to synchronize the Cellular Adapter. For example, when using a one-second clock, you would select **Not** after synchronization to prevent the Cellular Adapter's internal even-second clock from being retriggered half-way through its cycle.

### Gain

This field sets the IF gain of the CDMA analyzer for Rho, EVM, and Channel Power measurements. (Range: 0 dB to 36 dB in 6 dB steps.)

Gain is adjusted two ways:

- **Auto** measures the signal level and automatically adjusts the gain.
- **Hold** disables automatic operation to allow you to manually enter the desired gain by selecting the current gain setting and entering a new value using the keypad or Cursor Control knob.

This field is replaced by the **Pwr Gain** field when measuring Average Power. (See **Input Atten**.)

### Input Atten

This field controls the RF attenuators of the Test Set. If an "ADC Overdriven" message is displayed at the top of the screen while making measurements, increase the attenuator setting until the message is no longer displayed. This is the "course" level adjustment for the signal level into the CDMA Analyzer. Fine level adjustment is performed by the **Gain** field. (See *Gain*)

---

#### **NOTE:**

The **Input Atten** setting does not affect, and is not displayed with, the Average Power measurement.

**Input Port** This field selects which Test Set port to use as the RF input. This field is not displayed when measuring Average Power, since you *must* use the RF IN/OUT port for that measurement.

---

**INSTRUMENT  
DAMAGE**

To prevent instrument damage, do not exceed the maximum power level indicated below the connectors on your Test Set! The ANT IN connector is for measuring *low level* RF signals. High level (>200 mW) transmitter signals must be measured using the RF IN/OUT port.

---

**Meas Intvl** This field determines the length of the data block when measuring Rho, EVM, or Channel Power. The data block is a time record over which correlated measurements are computed.

As **Meas Intvl** is increased, measurement time is increased.

Increasing **Meas Intvl** gives more accurate measurement results, particularly with frequency error and phase error measurements.

Range: 0.25 to 1.25 ms

**PN Offset** Use this field to enter the PN Sequence Offset Index for your base station. Each whole offset is equal to 64 chips (=52.08 $\mu$ s). Fractional values are rounded off, and can be entered, in increments of 0.015625 (1 chip). This field is available on all of the CDMA screens. Once entered, this value is shared by all CDMA screens.

This value is used by the analyzer when the **Even Sec In** field on the CDMA GENERATOR screen is set to **Enable**. An external even-second clock must be used to synchronize the base station to the Cellular Adapter.

---

**NOTE:**

---

When the **Even Sec In** field is set to **Not**, changes to the **PN Offset** field have no effect on the Cellular Adapter's analyzer.

**Pwr Gain**

This field is used to set the level into the CDMA Analyzer when making Average Power measurements. Levels are set in 6 dB increments. The IF signal level is displayed as **ADC FS** when Average Power is measured, and should be between -1.0 and -10 dB for best measurement results.

**Auto** automatically sets the gain for an ADC FS value in the range of -1 to -10 dB. This is the recommended mode of operation.

**Hold** lets you override the automatic setting to manually set the gain.

This field is only displayed when the **Avg Pwr** measurement is selected. It is replaced by the **Gain** field for all other measurements.

**Pwr Intvl**

This field determines the length of the data block when measuring Average Power. The data block is a time record over which correlated measurements are computed.

Range: 0.25 to 5.00 ms

**Pwr Zero**

Selecting this field calibrates (zeroes) the Average Power meter. This operation should be performed immediately before making the Avg Pwr measurement. This field is only displayed if the Avg Pwr measurement is displayed; it is replaced by the **Ant Dir** field for all other measurements.

---

**REMOVE POWER**

To prevent the introduction of measurement offsets during calibration, disconnect any signals to the RF IN/OUT and ANT IN connectors before using this function.

---

## Qual Event

This field selects a trigger Qualifier. The trigger Qualifier serves as a precursor to the CDMA analyzer trigger event. Selecting a trigger Qualifier is required when a time-delayed trigger event is desired, or if the trigger signal is external (applied to the Cellular Adapter's front-panel TRIGGER/QUALIFIER IN).

If a time delayed trigger is used (see **Trig Event: Delay**), the Qualifier starts the delay timer. When the timer expires, a trigger event occurs and a measurement is made.

### Choices

- **None** causes the trigger event to be determined solely by the selection in the **Trig Event** field.
- **27 ms** is a clock signal generated by the Cellular Adapter.
- **20 ms** is a clock signal generated by the Cellular Adapter.
- **80 ms** is a clock signal generated by the Cellular Adapter.
- **2 s** is a clock signal generated by the Cellular Adapter.
- **Ampl Lo** qualifies a trigger each time the input to the CDMA analyzer rises to greater than  $-18$  dB ADC FS. **ADC FS** is displayed when the Avg Pwr measurement is selected, or when adjusting the **Gain** field on the CODE DOMAIN ANALYZER.
- **Ampl Mid** qualifies a trigger each time the input to the CDMA analyzer rises to greater than  $-12$  ADC FS. (See *Ampl Lo*)
- **Ampl Hi** qualifies a trigger each time the input to the CDMA analyzer rises to greater than  $-6$  ADC FS. (See *Ampl Lo*)
- **External** must be selected if the trigger qualifier is provided by an external source. The external signal connects to the Cellular Adapter's front-panel TRIGGER/QUALIFIER IN connector. A qualifier occurs on the input signal's rising edge.

Default selection: 80 ms

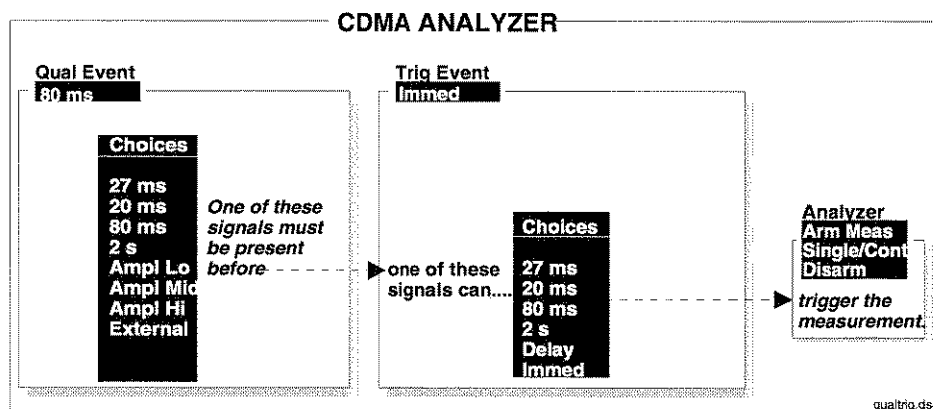

### Synth Ref

This field must be set to the frequency of an external reference signal connected to the Cellular Adapter rear-panel SYNTH REF IN connector. This signal provides a reference to the Cellular Adapter's RF synthesizer. The REF UNLOCK indicator on the front panel will light when the synthesizer reference signal is not compatible with the **Synth Ref** selection. (The **CDMA TB** reference and LO phase-locked loop can also cause the REF UNLOCK indicator to be lit.) This field is available on all CDMA screens; changing the value on one screen affects this value on all screens.

#### Choices

- 1
- 1.2288
- 2
- 2.4576
- 4.9152
- 5
- 9.8304
- 10
- 15
- 19.6608

Default selection: 10 (MHz)

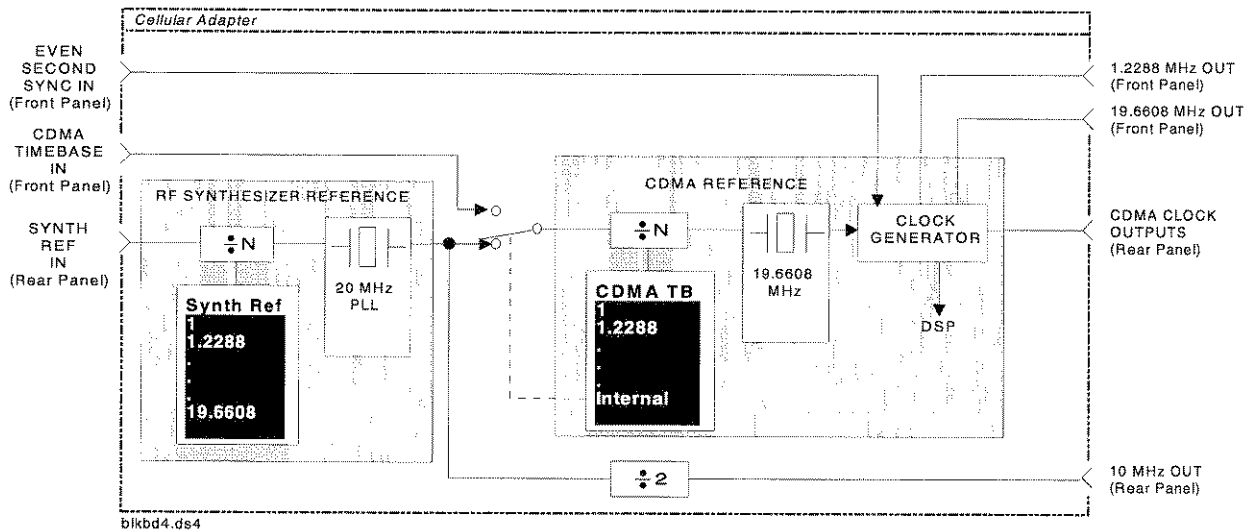

Figure 9 Cellular Adapter Connector Block Diagram



## Trig Event

This field determines when the trigger event to the CDMA analyzer occurs. When the selected trigger in this field is qualified by the selection in the **Qual Event** field, the CDMA analyzer is triggered.

### Choices

- **27 ms** is a clock signal generated by the Cellular Adapter.
- **20 ms** is a clock signal generated by the Cellular Adapter.
- **80 ms** is a clock signal generated by the Cellular Adapter.
- **2 s** is a clock signal generated by the Cellular Adapter.
- **Delay** controls a trigger delay timer, beginning from the positive edge of the selected qualifier. A delay of 20  $\mu$ s to 10,000,000  $\mu$ s is valid. Initially, the time delay will be 100  $\mu$ s.
- **Immed** triggers immediately after receiving the **Qual Event** signal.

Default selection: 'Immed'.

## Tune Freq

Use this field to enter the center frequency of the CDMA channel you are analyzing.

---

### **CHANNEL TUNING**

You can configure the Test Set to allow direct entry of channel numbers (instead of entering the frequency) by using the fields in the **RF Display** column on the CONFIGURE screen. CDMA base stations use the same channel numbers and frequencies associated with the AMPS standard (so select **LS AMPS** for the **RF Chan Std** field). Refer to the Test Set User's Guide for information on this function.

---

### **Chn Pwr Cal**

This field calibrates the Channel Power measurement. When this field is selected, power at the RF IN/OUT port is measured using the average power technique. Channel power is also measured and a correction factor is generated. This correction factor is applied to subsequent channel power measurements. Calibration should be performed whenever a new set of measurements is made and whenever the frequency of the measured signal is changed.

Channel power measured at the ANT IN port can be calibrated externally by applying equal power levels simultaneously to the RF IN/OUT and ANT IN ports.

---

***CALIBRATING THE  
CHANNEL POWER  
MEASUREMENT AT  
THE RF IN/OUT PORT  
USING THE  
INTERNAL CDMA  
GENERATOR***

1. Connect a short BNC-to-Type N cable between the DUPLEX OUT and RF IN/OUT connectors.
  2. Access the CDMA GENERATOR screen to create a measurement reference signal.
    - a Set the **RF Gen Freq** to the center frequency of your CDMA signal.
    - b Set the **Amplitude** to 4 dBm.
    - c Set the **CW Rf Path** to IQ.
    - d Set the **Output Port** to Dupl.
  3. Access the CDMA ANALYZER screen and set the **Tune Freq** to the center frequency of your CDMA signal.
  4. Select the **Chn Pwr Cal** field and wait until the Channel Pwr measurement stabilizes.
  5. Disconnect the cable and connect your transmitter to the RF IN/OUT connector to make a Channel Power measurement.
-

---

## CDMA Generator Screen

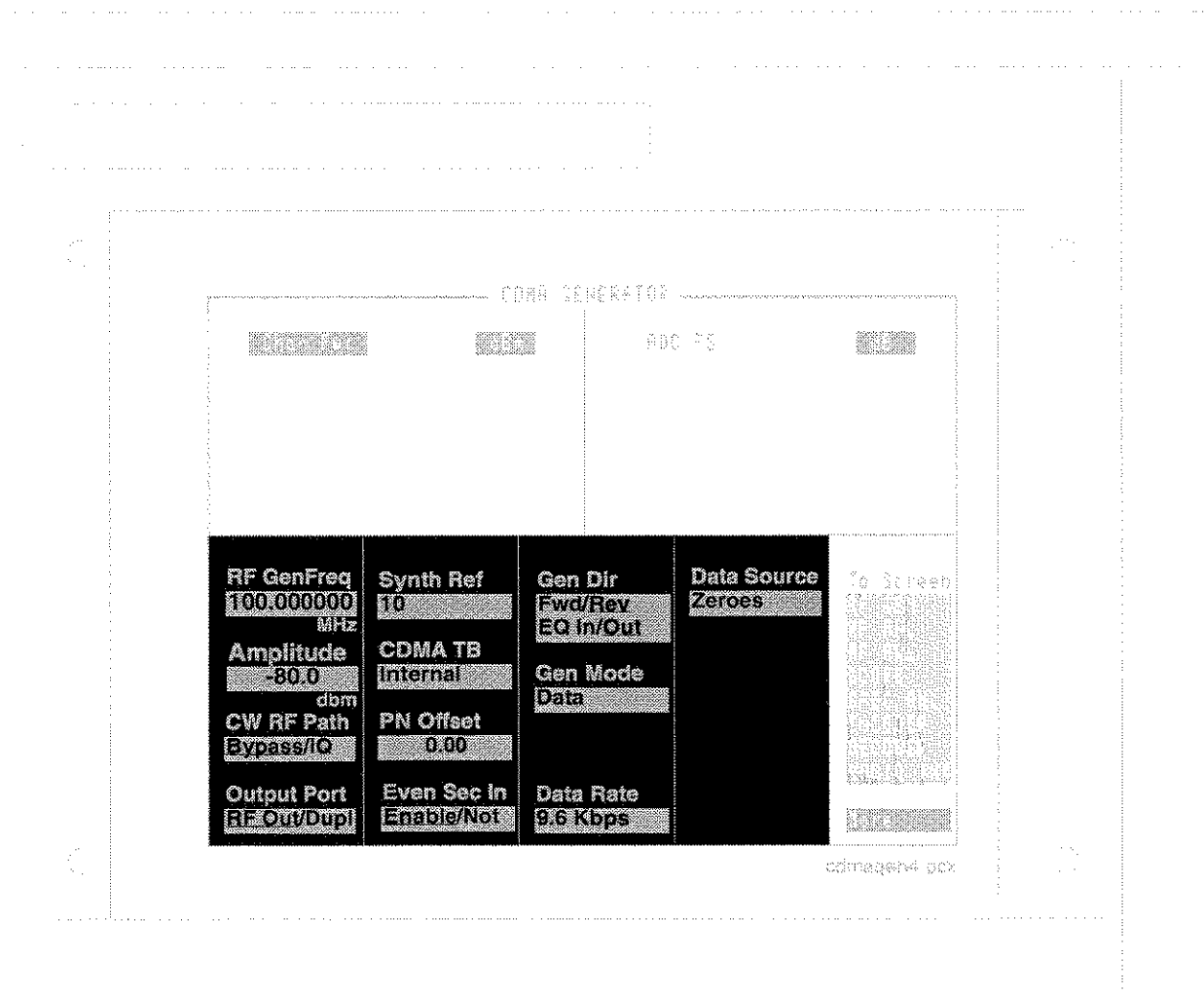

## CONTROL FIELDS

**# of Frames**            *See Data Source*

**Amplitude**            This field sets the output level of the CDMA Generator to the RF IN/OUT or DUPLEX port. Use the DUPLEX OUT port for signal levels greater than -19 dBm.

**CDMA TB**            This field selects the reference frequency for the CDMA reference phase-locked-loop. This field is available on all CDMA screens; changing the value on one screen affects this value on all screens. For more information about the **CDMA TB** and **Synth Ref** controls, see the **Synth Ref** field description, on page 112.

**Internal** locks the internal CDMA frame clocks to the RF Synthesizer's reference.

All other choices require an external signal connected to the CDMA TIMEBASE IN connector. The REF UNLOCK indicator on the front panel will light when the synthesizer reference signal is not compatible with the **Synth Ref** selection. (The **CDMA TB** reference and LO phase-locked loop can also cause the REF UNLOCK indicator to be lit.)

- 1
- 1.2288
- 2
- 2.4576
- 4.9152
- 5
- 9.8304
- 10
- 15
- 19.6608
- **Internal**

Default selection: **Internal**.

### **CW RF Path**

This field selects the path for the CW RF signal within the Cellular Adapter. The CW RF signal comes from the Test Set's CW RF OUT rear-panel connector.

- **Bypass** disables the Cellular Adapter's IQ modulator. This mode is used when generating standard AM, FM, or CW signals in the Test Set.
- **IQ** enables the Cellular Adapter's IQ modulator. This mode turns on the CDMA generator. If the **Data Source** field is set to **Data Buff**, **Alt Data**, **Rand Err**, or **Random**, the data stream is not output until **Send** is selected. (See Data Source)

Default selection: **Bypass**.

### **Data Rate**

This field allows receiver testing at data rates of 9.6 or 14.4 Kbps. This field may not be present on older instruments.

If the Data Buffer is the selected Data Source, and the Data Rate is changed, the transmission state will change to 'Idle'. Select 'Send' to resume data output at the new rate.

#### **Choices**

- **14.4 Kbps**
- **9.6 Kbps**

Default selection: 9.6 Kbps

### Data Source

This field selects where the baseband quadrature spreader gets its data. This field is removed when the **Gen Mode** field is set to **Noise**.

- **Zeroes** uses a data stream of all 0's that is not encoded before being applied to the baseband quadrature spreader and output.
- **Ext** uses external data from the front panel DATA IN connector. This data is not encoded before being applied to the baseband quadrature spreader.
- **Random** uses 300 frames of random, error-free data. (See **Data Buff** for **Single/Cont Idle/Send** operation.)
- **Data Buff** uses data previously loaded into the Cellular Adapter's Data Buffer. You can load your own data into the buffer over HP-IB, see **chapter 6, "CDMA Dual Mode Cellular Test HP-IB"**. This data is encoded before baseband quadrature spreading. Choosing this selection displays these three additional fields:
  - **Single** causes the data stream to be output once when **Send** is selected.
  - **Cont** causes the data stream to be repeated continuously when **Send** is selected. Changing to Single operation while sending causes the data to be interrupted after the current 20 ms frame.
  - **Send** causes the data stream to be output after two rising edges of the internal 80 ms clock are detected.
  - **Idle** indicates that data from the buffer is not being transmitted. Selecting Idle while sending data interrupts the data at the completion of the current 20 ms frame. A data stream of all zeroes (encoded) continues to be transmitted after the initial data stream is interrupted. This is different from the **Zeroes** selection above where the data is not encoded.
- **Start Frame** specifies the first frame of data to send.
- **# of Frames** specifies how many frames of data to send.

### EQ Filter

This field applies (**EQ In**) or bypasses (**Out**) the all-pass Equalization Filter. This field is automatically set by the Generator Direction (**Gen Dir**) field to apply equalization for generating forward link signals, and to bypass equalization for generating reverse link signals (as per IS-95 specifications). Use this field to override the automatic settings (if desired) after setting the **Gen Dir** field.

### Even Sec In

This field controls the internal connection of the EVEN SECOND/SYNC IN connector to the CDMA analyzer. This field is also provided on the CDMA ANALYZER screen.

- **Enable** When this mode is selected, signals applied to the EVEN SECOND IN/ SYNC IN synchronize the Cellular Adapter's timing circuits.
- **Not** When this mode is selected, input signals applied to the EVEN SECOND IN/ SYNC IN are ignored. This mode may be useful when signals other than an even-second clock are used to synchronize the Cellular Adapter. For example, when using a one-second clock, you would select **Not** after synchronization to prevent the Cellular Adapter's internal even-second clock from being retriggered half-way through its cycle.

---

#### NOTE:

---

When the **Even Sec In** field is set to **Not**, changes to the **PN Offset** field have no effect on the Cellular Adapter's analyzer.

### Gen Dir

This field sets the link direction of the CDMA signal.

- **Fwd** (forward) sets the CDMA generator to produce QPSK modulation to imitate a base station. The **EQ Filter** field is automatically set to **EQ In** to apply an equalizing filter to the I and Q paths as part of the baseband filtering.
- **Rev** (reverse) sets the CDMA generator to produce OQPSK modulation to imitate a mobile station. The **EQ Filter** field is automatically set to **Out** to remove the equalizing filter from the I and Q paths.

### Gen Mode

This field selects the type of modulation information sent to the CDMA generator's IQ modulator.

- **Data** allows data to be transmitted to simulate a traffic channel with no additive noise. (See **Data Source**.)
- **Eb/No** causes a combination of data and White Gaussian Noise (AWGN) noise to be transmitted. The value entered is the ratio between the energy of each information bit ( $E_b$ ) and the noise spectral density ( $N_o$ ), expressed in dB.
- **Noise** causes a signal modulated by White Gaussian Noise to be generated. The noise is band limited to 2 MHz and white inside a 1.25 MHz bandwidth centered around the **RF Gen Freq**. This selection removes the **Data Source**, **Start Frame**, and **# of Frames** fields from the screen; those fields are only used with the **Data** and **Eb/No** entries.

**Output Port** This field selects the Test Set port the CDMA Generator sends its signal to (RF IN/OUT or DUPLEX OUT).

**PN Offset** Use this field to enter the PN Sequence Offset Index for your base station. Each whole offset is equal to 64 chips (=52.08  $\mu$  s). Fractional values are rounded off to, and can be entered in, increments of 0.015625 (1 chip). This field is available on all of the CDMA screens. Once entered, this value is shared by all CDMA screens.

This value is used by the analyzer when the **Even Sec In** field is set to **Enable**. An external even-second clock must be used to synchronize the base station to the Cellular Adapter.

---

**NOTE:** When the **Even Sec In** field is set to **Not**, changes to the **PN Offset** field have no effect on the Cellular Adapter's analyzer.

---

**RF Gen Freq** This field specifies the center frequency of the generated CDMA signal.

---

**CHANNEL TUNING** You can configure the Test Set to allow direct entry of channel numbers (instead of entering the frequency) by using the fields in the **RF Display** column on the CONFIGURE screen (set **RF Display** to **Chan**, and set **RF Chan Std** to **LS AMPS**). Refer to the Test Set User's Guide for information on this function.

---

**Send Mode** See *Data Source*

**Start Frame** See *Data Source*



## **Synth Ref**

This field must be set to the frequency of an external reference signal connected to the Cellular Adapter rear-panel SYNTH REF IN connector. This signal provides a reference to the Cellular Adapter's RF synthesizer. The REF UNLOCK indicator on the front panel is lit when the synthesizer is not able to phase-lock to the selected reference. This field is available on all CDMA screens; changing the value on one screen affects this value on all screens. For more information about the CDMA TB and Synth Ref controls, see the Synth Ref field description, on page 112.

### **Choices**

- 1
- 1.2288
- 2
- 2.4576
- 4.9152
- 5
- 9.8304
- 10
- 15
- 19.6608

Default selection: 10 (MHz)

## Code Domain Analyzer Screen

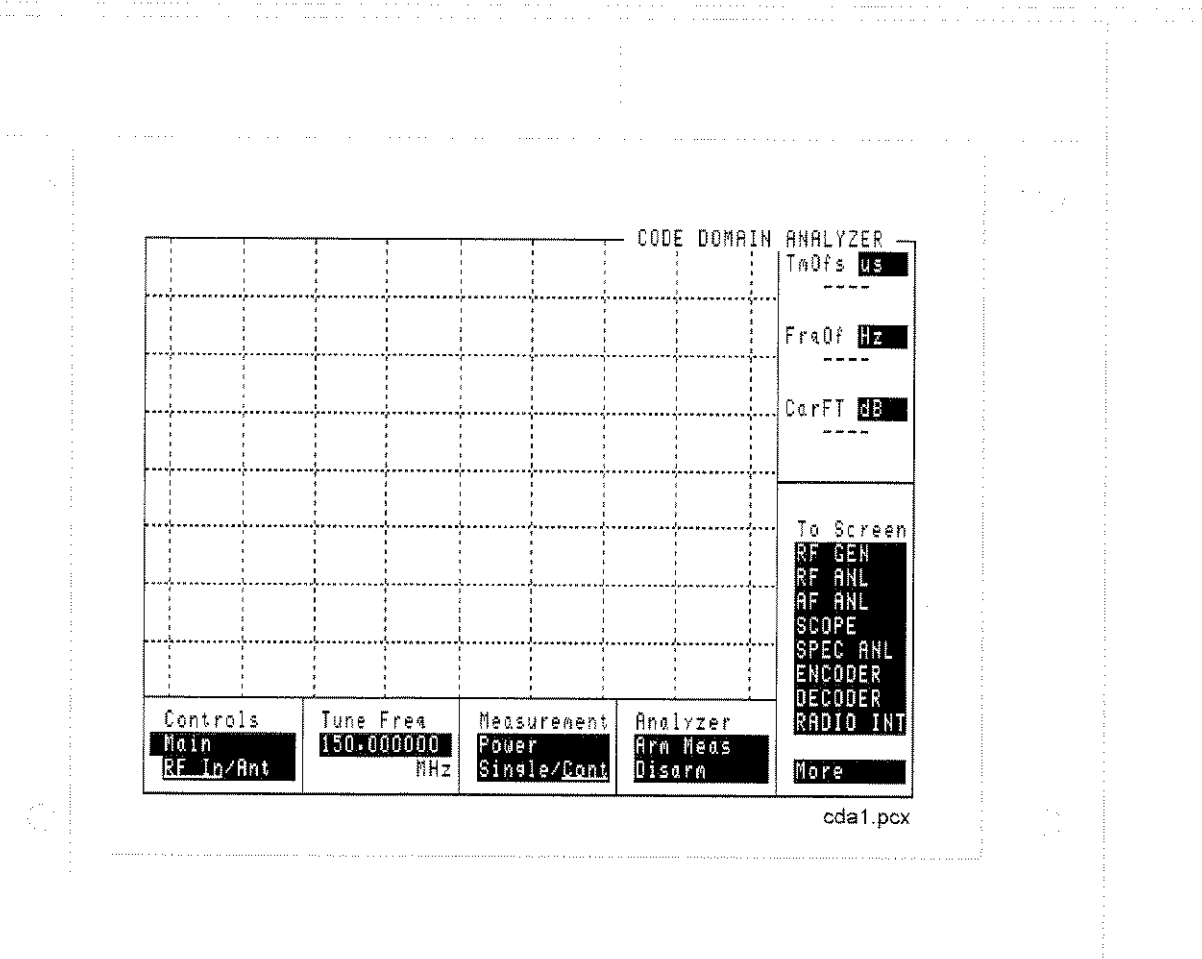

## MEASUREMENT FIELDS

The Code Domain Analyzer screen resembles a spectrum analyzer in many aspects. Many of the same features, such as Markers, are shared by these functions. However, where the spectrum analyzer displays signal level verses frequency, the Code Domain analyzer displays the relative signal level, timing, and phase of each Walsh Channel in the CDMA signal.

*The Code Domain Analyzer is designed to measure Forward (base station transmitter) signals.*

Use the **Measurement** field to select the type of Code Domain measurement to display. Use the **Marker** functions to move the marker to an individual Walsh Channel to display its measurement value.

### **Power**

Code Domain Power displays the power for each of the 64 Walsh Channels, relative to the total power inside a 1.23 MHz bandwidth centered at the Tune Frequency. Each Walsh Channel level is displayed as an individual vertical bar. Because this is a relative measurement, the unit of measure is always dB (not dBm or watts). This allows a comparison of signal levels between the Pilot, Sync, Paging, and Traffic channels.

### Fast Power

**Fast Power** is a faster method of measuring Code Domain Power. A value for **Time Offset** must be transferred from a non-fast power measurement before measurements begin, or when changes to the following fields occur:

- Data Rate
- PN Offset
- CDMA TB
- Synth Ref

Refer to the **Ofs Transfer** field description under FP Setup Menu Controls.

The number of measurement averages desired can be entered in the FP Setup menu. These values are then used to calculate and display successive Code Domain Power measurements.

### Timing and Phase

**Code Domain Phase** displays the phase error for each of the 64 Walsh Channels, *relative to the Pilot Channel* (Walsh 0). Measurements are displayed as vertical bars above or below a zero reference in the center of the screen. Signals above the reference are leading in phase; signals below are lagging.

**Code Domain Timing** displays the time offset for each of the 64 Walsh Channels, *relative to the Pilot Channel* (Walsh 0). Measurements are displayed as vertical bars above or below a zero reference in the center of the screen. Signals above the reference are leading in time; signals below are lagging.

## CONTROL MENUS

CODE DOMAIN ANALYZER settings are arranged into several menus that are accessed using the **Controls** field. The control groups are:

- **Main** accesses the **RF In/Ant**, **Tune Freq**, **Measurement**, and **Analyzer** fields.
- **Marker** controls the marker to look at the level of individual Walsh Channels.
- **Trigger** accesses the trigger controls: **Qual Event** and **Trig Event**.
- **Aux** accesses the **PN Offset**, measurement **Threshold**, and measurement **Interval** fields.
- **Gain** lets you alter the gain into the CDMA Analyzer while reading the **ADCfs** value.
- **Refs** accesses the **CDMA TB** and **SYNTH REF** controls to provide measurement synchronization.
- **FP Setup** accesses the **Ofs Trnsfer** and **Num Avgs** field used to make **Fast Power** measurements.

Many of these controls are duplicates from the CDMA ANALYZER and CDMA GENERATOR screens.

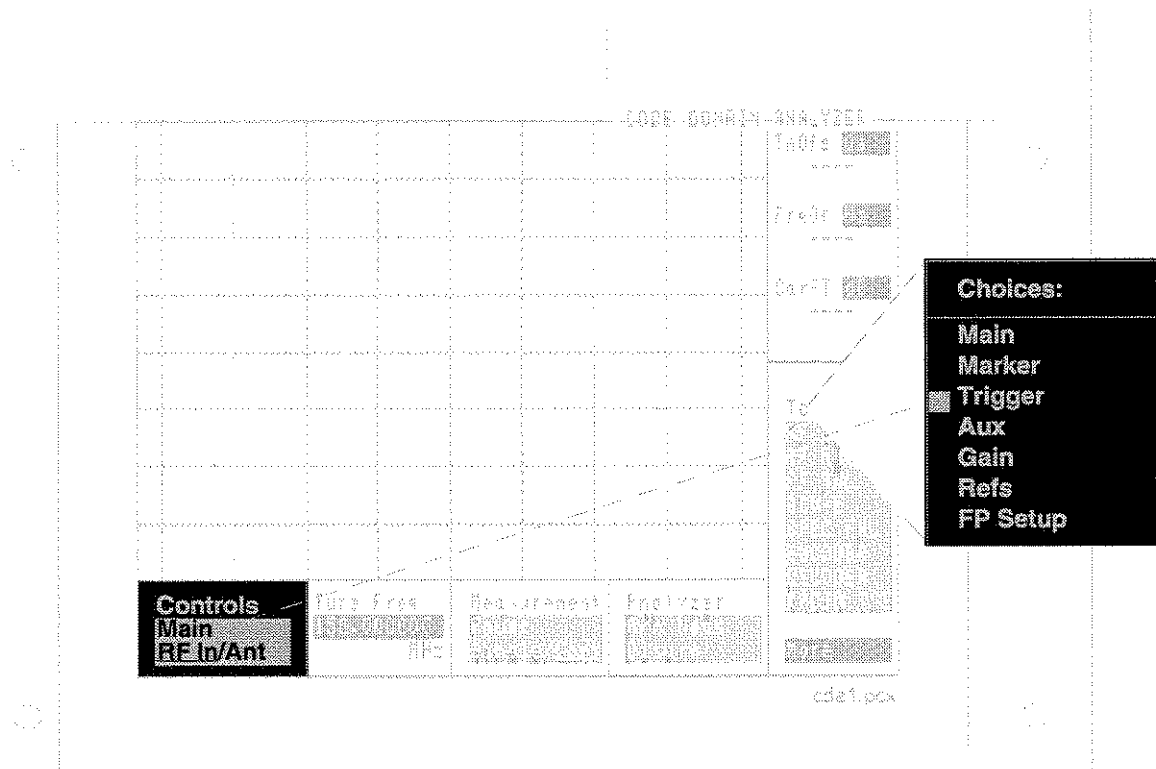

## Main Menu Controls

Controls	Tune Freq	Measurement	Analyzer	RADIO INT
Main	893.310000	Power	Arm Meas	More
RF In/Ant	MHz	Single/Cont	Disarm	

screen6.ds4

### RF In/Ant

This field selects the Test Set's RF input. For recommended input levels, see "Recommended Input Levels" on page 136.

---

#### CAUTION:

The maximum safe level into the ANT IN connector is 200 mW. Exceeding this level could cause permanent damage to the Test Set.

### Tune Freq

Use this field to enter the center frequency of the CDMA channel you are analyzing.

---

#### CHANNEL TUNING

You can configure the Test Set to allow direct entry of channel numbers (instead of entering the frequency) by using the fields in the **RF Display** column on the **CONFIGURE** screen. CDMA base stations use the same channel numbers and frequencies associated with the AMPS standard (so select **LS AMPS** for the **RF Chan Std** field). Refer to the Test Set User's Guide for information on this function.

### Measurement

This field controls the type of Code Domain measurement to make: Power, Timing, or Phase. It also controls the measurement "mode":

- **Single** is used when you want to make one measurement. You must select the **Arm Meas** function of the **Analyzer** field before a measurement can be made.
- **Cont** is used to continuously make measurements. Measurements are automatically re-armed after each measurement.

### Analyzer

This field is used to Arm or Disarm measurements when making a *Single* measurement (does not affect Continuous measurements). Selecting Disarm stops the analyzer during a Single measurement.

## Aux Menu Controls

Controls	Interval	PN Offset	Threshold	RADIO INT
Aux	0.50 ms	0.0	-20.0 dB	More

screen7.ds4

### Interval

This field determines the length of the data block. The data block is a time record over which correlated measurements are computed. As **Interval** is increased, measurement time is increased. Increasing **Interval** gives more accurate measurement results, particularly with frequency error and phase error measurements.

### PN Offset

Enter the PN Offset of your base station to time-align the CDMA Cellular Adapter's PN Sequence with the base station.

This value is used by the analyzer when the **Even Sec In** field on the CDMA GENERATOR screen is set to **Enable**. An external even-second clock must be used to synchronize the base station to the Cellular Adapter.

---

### NOTE:

---

When the **Even Sec In** field is set to **Not**, changes to the **PN Offset** field have no effect on the Cellular Adapter's analyzer.

### Threshold

Enter the measurement display threshold for making Code Domain Timing and Phase measurements. Walsh Channels that have power levels below the threshold value are not displayed. Querying these measurements for Walsh Channels that are below the threshold level using HP-IB will return a default value of 9e99.

## FP Setup Menu Controls

Controls	Time Offset	Ofs Transfer	Num Avgs	RADIO INT
FP Setup	0.00	Transfer	1	More
	us			

screen8.ds4

### Time Offset

This field allows you to manually enter a time offset. To obtain a value to enter in this field you must make at least one of the following measurements

- Power
- Timing
- Phase
- Rho

After making the measurement, access the FP Setup screen, and enter the value obtained from the **TM Ofs** field or, for Rho measurements, the **Time Offset** measurement field on the CDMA ANALYZER screen.

An entry into the **Time Offset** field can also be made automatically, using the **Ofs Transfer** field. See the **Ofs Transfer** field description, on page 129.

The Code Domain Analyzer, when measuring Fast Power, uses the value in the Time Offset field instead of re-measuring the time offset parameters each time a Code Domain measurement is made



### **Ofs Transfer**

This field transfers the time offset value from the **Tm Ofs** field to the **Time Offset** field automatically. Before selecting **Ofs Transfer**, you must make at least one of the following measurements:

- Power
- Timing
- Phase

When you select **Ofs Transfer**, the measured time offset value displayed in the **Tm Ofs** field in the upper-right portion of the display will be entered into the **Time Offset** field.

When using this command programmatically, be sure a value for **Tm Ofs** has been obtained from a Power, Timing, or Phase measurement. (One method of ensuring the measurement has completed would be to send an HP-IB command to query the results of the **Tm Ofs** field before sending the transfer command).

### **Num Avgs**

The Number of Averages determines how many measurements are averaged when measuring Fast Power. Averaging reduces measurement speed.

## Gain Menu Controls

Controls	Gain	ADCFs	dB	RADIO INT
Gain	0.0		dB	More

screen9.ds4

### Gain

Alters the IF level into the CDMA Analyzer. (Range: 0 dB to 36 dB.)

### ADCFs

Indicates how close the measured power level is to the maximum allowed input level for the analyzer's Analog-to-Digital Converter (ADC). This level is affected by the **Gain** setting, the **Input Atten** setting on the CDMA ANALYZER screen, and the RF level of the signal connected to the Test Set.

For best measurement performance, ADCfs should be between  $-1.0$  and  $-10$  dB. The measurement will be aborted if ADCfs goes above 0 dB. Measurement accuracy may be degraded if ADCfs goes below  $-10$  dB.

**Marker Menu  
Controls**

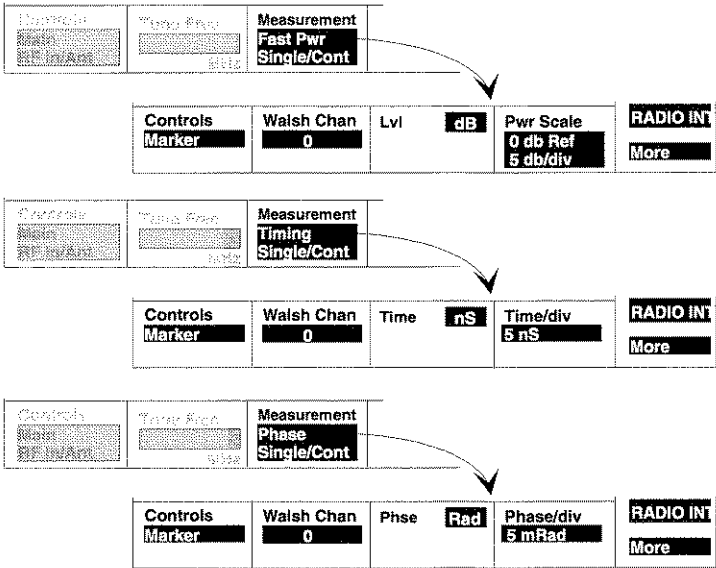

screen10.ds4

**Walsh Chan**

This field selects the Walsh Channel to move the marker to. The marker can be moved by either entering the Walsh Channel number directly using the keypad, or by using the Cursor Control knob.

#### **Lvl**

This measurement displays the relative level of the selected Walsh Channel when compared to the total power in a 1.23 MHz bandwidth centered around the **Tune Freq** setting. The measurement is displayed when the **Main** controls **Measurement** field is set to **Power** or **Fast Pwr**.

#### **Time**

This measurement displays the time difference between the selected Walsh Channel and the Pilot (Walsh 0). The measurement is displayed when the **Main** controls **Measurement** field is set to **Timing**

#### **Phase**

This measurement displays the phase difference between the selected Walsh Channel and the Pilot (Walsh 0). The measurement is displayed when the **Main** controls **Measurement** field is set to **Phase**

#### **Pwr Scale**

The upper part of this field is used to select the reference level for power measurements (relative to the total power of the entire CDMA channel). The reference is the top line of the screen and defaults to 0 dB.

The lower part of this field is used to select the display resolution for the power measurement; 1, 2 or 5 dB per vertical division.

These fields are displayed when the **Main** controls **Measurement** field is set to **Power** or **Fast Pwr**.

#### **Time/div**

This field is used to select the time-per-division display scale for Code Domain Timing measurements. The default is 5 ns/div. This field is displayed when the **Main** controls **Measurement** field is set to **Timing**.

#### **Phase/div**

This field is used to select the phase-per-division display scale for Code Domain Phase measurements. The default is 5 mRad/div. This field is displayed when the **Main** controls **Measurement** field is set to **Phase**.

## Refs Menu Controls

Controls	Synth Ref	CDMA TB		RADIO INT
Refs	10 us	27 ms		More

screen11.ds4

### Synth Ref

Select the frequency (MHz) from a list of choices that can be connected to the rear panel SYTH REF IN connector to phase lock the Cellular Adapter's RF Synthesizer to the base station. The REF UNLOCK indicator on the Cellular Adapter is lit if it cannot lock to the selected signal.

### CDMA TB

Select the frequency (MHz) from a list of choices that can be connected to the front panel CDMA TIMEBASE IN connector to phase lock the Cellular Adapter's timebase to the base station's timebase. The default is **Internal**; a signal derived from the SYNTH REF IN connector's signal. The REF UNLOCK indicator on the Cellular Adapter is lit if it cannot lock to the selected signal. For more information about the **CDMA TB** and **Synth Ref** controls, see the **Synth Ref** field description, on page 112.

## Trigger Menu Controls

Controls	Qual Event	Trig Event		RADIO INT
Trigger	80 ms	Immed		More

screen13.ds4

### Qualifier and Trigger

These controls determine which signals are used to trigger the Code Domain Analyzer. For an explanation of how these fields work together, see the [Qual Event](#) field description, on page 111.

---

## Connectors, Indicators, and Miscellaneous Hardware

The following descriptions are for the Cellular Adapter.

The fields indicated in these descriptions are shown on the **CDMA ANALYZER** or **CDMA GENERATOR** screens. For field and measurement descriptions for these screens, see chapter 4, "CDMA Screens Descriptions"

---

## Recommended Input Levels

**Table 1**                      **Input Level Considerations**

<b>Input Atten</b>	<b>ANT IN Peak Input Power</b>	<b>RF IN/OUT with 14 dB Input Attenuator</b>
0 dB	-16 dBm	+20 dBm
20 dB	+4 dBm	+40 dBm
40 dB	+23 dBm	+47.8 dBm

Crest factor of IS 95 Forward Link channels:

- Pilot only: approximately 7 dB
- Pilot + Sync + Paging + Traffic: variable crest factor greater than 7 dB



## Timebase Connections

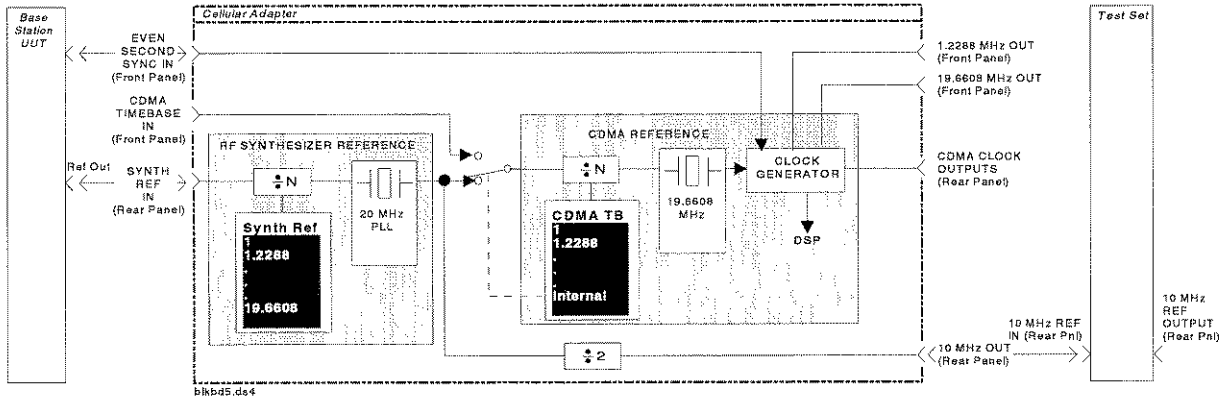

Figure 10 Typical Setup for Base Station Tests

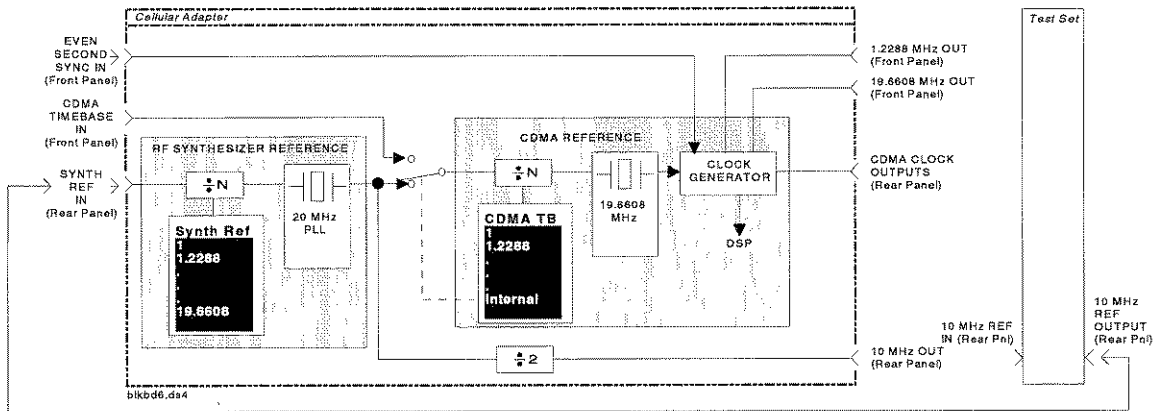

Figure 11 Typical Setup for Stand Alone Operation

---

## Connectors

### 1.2288 MHz OUT CHIP CLOCK

This front-panel output provides a 1.2288 MHz (CDMA chip rate) square wave with a 50% duty cycle. This signal comes from the CDMA frame clocks.

#### Operating Considerations

Nominal output level = CMOS

Output impedance = 50Ω

Frequency accuracy = the same as the signal applied to the CDMA TIMEBASE IN connector when a reference frequency is chosen in the **CDMA TB** field. When **Internal** is chosen, the frequency stability of the CDMA frame clocks is determined by the SYNTH REF IN signal.

### 19.6608 MHz OUT 16 × CHIP CLOCK

This front-panel output provides a 19.6608 MHz (16 times the CDMA chip rate) square wave with a 50% duty cycle. This signal comes from the CDMA frame clocks.

#### Operating Considerations

Nominal output level = CMOS

Output impedance = 50Ω

Frequency accuracy = the same as the signal applied to the CDMA TIMEBASE IN connector when a reference frequency is chosen in the **CDMA TB** field. When **Internal** is chosen, the frequency stability of the CDMA frame clocks is determined by the SYNTH REF IN signal.

## 10 MHz OUT

This rear-panel port outputs a 10 MHz reference. This signal is phase locked to the signal applied to the SYNTH REF IN port. All CDMA frame clocks are phase locked to this signal when the **CDMA TB** field is set to **Internal**.

### Operating Considerations

Nominal output level: >+5 dBm

Output impedance = 50Ω

Frequency accuracy = the same as the signal applied to the SYNTH REF IN connector. (The reference input must be within ±10 ppm of the selected **Synth Ref** frequency).

### See Also

For more information, see "REF UNLOCK Indicator" on page 147, and see "SYNTH REF IN" on page 145.

## 114.3 MHz IF IN

This rear-panel port is where the Cellular Adapter receives the 114.3 MHz IF from the Test Set's receiver section. It is usually connected to the Test Set's 114.3 MHz IF OUT port.

### Operating Considerations

Input impedance = 50Ω

Input level range = -53 to -20 dBm

Input Bandwidth = the incoming signal is downconverted to a second IF of 3.6864 MHz. An 8 MHz LPF provides additional filtering before being analyzed.

### See Also

For more information see see "114.3 MHz IF IN" on page 139.

### AUX DSP IN

This rear-panel port is where the Cellular Adapter receives the signal from the Test Set's DET OUT connector to make Average Power measurements.

#### Operating Considerations

Nominal Input impedance =  $100\Omega$

### CDMA CLOCK OUTPUTS

This connector provides 20 ms, 27 ms, 80 ms, and 2s CDMA frame clocks on a rear-panel 9-pin connector. Nominal output level = CMOS.

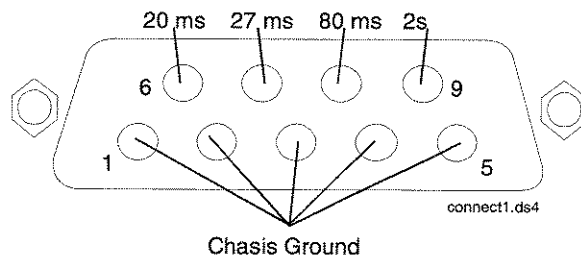

See "Timing Diagrams" on page 194 for an illustration of the timing relationships between the front panel EVEN SEC/SYNC input and the CDMA frame clock outputs.

## **CDMA TIMEBASE IN**

This front-panel port is the CDMA timebase input to the CDMA reference phase locked loop. When the `CDMA TB` field is set to `Internal`, the CDMA frame clocks are phase locked to the RF synthesizer's 10 MHz reference. When one of the following frequencies are chosen, the CDMA frame clocks are locked to the signal on the CDMA TIMEBASE IN connector. For more information about the `CDMA TB` and `Synth Ref` controls, see "Synth Ref" on page 112.

- 1
- 1.2288
- 2
- 2.4576
- 4.9152
- 5
- 9.8304
- 10
- 15
- 19.6608

### **Operating Considerations**

Frequency accuracy typically needed for phase lock:  $\pm 10$  ppm

Input impedance =  $50\Omega$

Input level = 0 dBm to +23 dBm

## **CONTROL I/O**

This rear-panel connector provides data communication between the Test Set and the Cellular Adapter. The Cellular Adapter cannot be turned on without this cable attached to an operating Test Set.

## CW RF IN

This rear-panel port is the RF carrier input to the Cellular Adapter. This signal is normally connected to the Test Set's CW RF Out port.

### Operating Considerations

If the **CW RF Path** field is set to IQ, the CW signal is modulated by I and Q drive signals before being routed to the rear-panel IQ RF OUT connector. If this field is set to Bypass, this signal is routed directly to the IQ RF OUT connector without being modulated.

---

### NOTE:

If the rear-panel RF cables are not connected between the Cellular Adapter and the Test Set, a cable must be connected between the Test Set's CW RF OUT and IQ RF IN ports to allow the Test Set to function by itself.

---

Nominal input level = 0 dBm,  $\pm 4$  dB

Maximum input level = +12 dBm

Input impedance = 50 $\Omega$

Frequency range:

- 500 to 1000 MHz without IQ modulation
- 810 to 956 MHz with IQ modulation.

### See Also

For more information, see "IQ RF OUT" on page 144.

## DATA IN

This front-panel port provides a data input to the CDMA Generator. The Cellular Adapter has the capability to perform quadrature spreading on this data input.

### Operating Considerations

Input level = TTL

Input impedance = 50 k $\Omega$

Data Rate = 1.2288 Mcps

**DIAGNOSTIC  
MONITOR OUT**

This front-panel port provides various signals used to service the Cellular Adapter.

When servicing the Cellular Adapter, this port is connected directly to the Test Set's AUDIO IN (HI) connector. Diagnostic routines are then run using the Test Set's internal IBASIC computer to locate a faulty module.

**EVEN SECOND/  
SYNC IN**

This front-panel port is an input for the even second clock from the base station under test. A positive edge on this connector starts two timers. One timer, after reaching terminal counts, starts CDMA frame clocks. The other timer starts pilot PN sequence generation; see "Timing Diagrams" on page 194. The **Even Sec In** field on the CDMA GENERATOR screen controls this port, see "Even Sec In" on page 119.

**Operating Considerations**

Input impedance = 50 k $\Omega$

Input level range = TTL

**I Baseband Out/Q  
Baseband Out**

These rear-panel outputs provide buffered versions of the I and Q drive signals (the signals driving the inputs to the Cellular Adapter's I/Q modulator).

**Operating Considerations**

The I and Q drive signals are balanced by DACs that provide the correct dc offset for the I/Q modulator in the Cellular Adapter. These offset adjustments will not necessarily be correct for I/Q modulators other than the Cellular Adapter.

Output impedance = 50 $\Omega$

Nominal output level = 250 mV (open circuit)

Frequency = approximately 600 kHz

## **IQ RF OUT**

This rear-panel port is the output for the RF carrier. The carrier may or may not be IQ modulated, depending on the **CW RF Path** field setting.

This port is normally connected to the Test Set's rear-panel IQ RF IN connector.

### **Operating Considerations**

When the **CW RF Path** field is set to IQ, the carrier is **always** IQ modulated.

- Output impedance = 50 $\Omega$
- Nominal output level:
  - -9.5 dBm when IQ modulated.
  - 0 dBm un-modulated (CW).
- Frequency range:
  - 500 to 1000 MHz without IQ modulation
  - 810 to 956 MHz with IQ modulation.

## **MAINS (LINE)**

This connection furnishes AC Line power to the Cellular Adapter however, the instrument is not turned on until the connected Test Set is turned on.

### **Operating Considerations**

Line Voltage range: 100 V to 240 V

Line Frequency range: 50 Hz to 60 Hz

Typical power consumption: < 120 VA over the entire range of line voltages and frequencies.

---

#### **WARNING:**

**Using line voltages and/or frequencies other than those listed can cause an electrical shock and/or fire hazard.**

---

#### **NOTE:**

The Test Set can be operated without AC line power to the Cellular Adapter if the rear-panel RF cables are connected between the two instruments.

#### **See Also**

Refer to the in chapter 6 of the Test Set's User's Guide for a list of available power cords.



**Q Baseband Out  
(See I Baseband  
Out)**

**SYNTH REF IN**

This rear-panel connector provides a phase reference for the RF synthesizer. One of the following frequencies (in MHz) must be used:

- 1
- 1.2288
- 2
- 2.4576
- 4.9152
- 5
- 9.8304
- 10
- 15
- 19.6608

The Test Set's 10 MHz REF OUTPUT is normally used as a reference signal.

**Operating Considerations**

The reference frequency applied to the SYNTH REF IN port must be specified in the **Synth Ref** field. The REF UNLOCK indicator on the front panel will light when the synthesizer reference signal is not compatible with the **Synth Ref** selection. (The **CDMA TB** reference and LO phase-locked loop can also cause the REF UNLOCK indicator to be lit.) For more information about the **CDMA TB** and **Synth Ref** controls, see "Synth Ref" on page 112.

If an external reference, rather than the Test Set's 10 MHz REF OUT, is used as the RF synthesizer reference, the Cellular Adapter's 10 MHz REF OUTPUT should be connected to the Test Set's 10 MHz REF INPUT to phase lock the Test Set to the same external reference. Any external reference must be spectrally pure (very low noise) to provide a noise-free 10 MHz REF OUT signal and allow the HP 83201 to achieve phase lock.

Frequency accuracy typically needed for phase lock:  $\pm 10$  ppm

Nominal Input impedance:

- For 1 to 19.6608 MHz signals:  $50\Omega$

Input level:

- For 1 to 19.6608 MHz signals: 0 dBm to +23 dBm

**TRIGGER/  
QUALIFIER IN**

This front-panel input is active when an external trigger qualifier is selected.

If the trigger is to occur on the TRIGGER/QUALIFIER IN signal, select **Delay** in the **Trigger** field and select a delay of 0.0  $\mu$ s. If the TRIGGER/QUALIFIER IN signal is a qualifier, select a trigger source in the **Trigger** field.

**Operating Considerations**

Input impedance = 50 k $\Omega$

Input level range = TTL

**See Also**

For more information, see "Qual Event" on page 111, and see "Trig Event" on page 113. For troubleshooting information see "Example of Trigger Event Timing Problems" on page 97.

**RF IN/OUT**

This type-N connector is only present on cellular adapters with option 002 or 003, and is only used for CDPD testing. This port is sampled by the cellular adapter's Digital Signal Processor, and is connected to the base station's RF output to measure signals up to 60 W. Refer to the *CDPD MDBS Software User's Guide* for more information.

**RF IN/OUT TO  
TEST SET**

This type-N connector is only present on cellular adapters with option 002 or 003, and is only used for CDPD testing. This port is connected to the Test Sets RF IN/OUT port to provide RF measurements on the CDPD signal. Refer to the *CDPD MDBS Software User's Guide* for more information.

---

## Indicators

### **PWR Indicator**

This indicator lights when the Cellular Adapter is turned on. There is no separate POWER switch for the Adapter. After mains (line) power is supplied, the Adapter is turned on when the connected Test Set is turned on.

### **REF UNLOCK Indicator**

This indicator lights under the following conditions:

- The synthesizer reference PLL is out-of-lock.
- The CDMA timebase PLL is out-of-lock.
- The LO PLL is out-of-lock.

This condition exists when the frequency of the reference signal or the CDMA timebase input (if used) does not match the setting for the **Synth Ref** field, or the **CDMA TB** field, or when a reference signal level is incompatible.

#### **See Also**

For more information, see "SYNTH REF IN" on page 145, and see "CDMA TIMEBASE IN" on page 141.

---

## Miscellaneous Hardware

### FUSE

An internal fuse provides over-current protection for the Cellular Adapter. The fuse may need replacement if mains power has been connected but the Cellular Adapter's PWR indicator *and* cooling fan are off with the Test Set correctly connected and operating properly.

Refer to the Cellular Adapter Assembly Level Repair Manual for instructions on removing the instrument cover to replace the fuse.

#### Operating Considerations

Rating: 2.0 Amp, 250 V Size: AGC Type: normal blow

---

#### **WARNING:**

**Replacing a fuse with a different type, size, or rating than is supplied with the instrument can cause an electrical shock and/or fire hazard.**

---

---

## CDMA Dual Mode Cellular Test HP-IB

This chapter contains status reporting information, programming examples, and HP-IB command syntax drawings specific to the Cellular Adapter.

Refer to the Test Sets's HP-IB *Programmer's Guide* (PN 08920-90204) for general information about HP-IB operation, including HP-IB command syntax for the Test Set. For detailed IBASIC programming information, refer to the *HP Instrument BASIC User's Handbook* (PN E2083-90005).

---

## Example Programs

**RF Loop-back/ Rho Measurements** This program example uses a Test Set and an Cellular Adapter to create and analyze a CDMA signal. The CDMA Analyzer makes Rho, Frequency Error, Time Offset, and Carrier Feedthru measurements and prints them. A cable is used to route the signal from the DUPLEX OUT port to the RF IN/OUT port.

**Loopback Example Program (HP Instrument BASIC)**

```
10 Hpib=714                !This example uses the default HP-IB address 714.
20 CLEAR SCREEN
30 OUTPUT Hpib;"*RST"      !Preset the Test Set to a known state.
40 INPUT "Cable DUPLEX OUT to RF IN - press ENTER on controller.",AS
50 OUTPUT Hpib;"DISP CGEN" !Display the CDMA Generator screen.
60 OUTPUT Hpib;"RFG:FREQ 850 MHZ" !Set the RF Gen Freq to 850 MHz.
70 OUTPUT Hpib;"RFG:AMPL -10 dbm" !Set Amplitude to -10 dBm.
80 OUTPUT Hpib;"CCOM:PATH 'IQ'" !Set create CDMA signals.
90 OUTPUT Hpib;"RFG:OUTP 'Dupl'" !Set the Output Port to Duplex.
100 OUTPUT Hpib;"CGEN:DIR 'Fwd'" !(match the analyzer direction).
110 OUTPUT Hpib;"DISP CAN" !Display the CDMA Analyzer screen.
120 OUTPUT Hpib;"CAN:MODE 'Rho'" !Select the Rho measurement.
130 OUTPUT Hpib;"RFAN:FREQ 850 MHZ" !Set the Tune Freq.
140 OUTPUT Hpib;"MEAS:CAN:RHO?" !Read the Rho Measurement value.
150 ENTER Hpib;Rho_val      !Enter the value for Rho into a variable.
160 OUTPUT Hpib;"MEAS:CAN:TIME:OFFS?" !Read back Time Offset.
170 ENTER Hpib;Time_off_val
180 OUTPUT Hpib;"MEAS:CAN:ERR:FREQ?" !Read back Frequency Error.
190 ENTER Hpib;Freq_error_val
200 OUTPUT Hpib;"MEAS:CAN:CAR:FEED?" !Read back Carrier Feedthru.
210 ENTER Hpib;Carr_fdthru_val
220 PRINT "Rho=";Rho_val;"dB" !Print the Rho value.
230 PRINT "Time Offset=";Time_off_val;"us"
240 PRINT "Frequency Error=";Freq_error_val;"Hz"
250 PRINT "Carrier Feedthru=";Carr_fdthru_val;"dB"
260 END
```

**Code Domain  
Power  
Measurement**

This program example uses the Test Set and Cellular Adapter to create and analyze a CDMA signal using the Code Domain Analyzer. The analyzer measures the relative power level of all Walsh Channels in that signal. The Marker functions of the Code Domain Analyzer are used to specify which of the 64 Walsh Channels to query (Walsh Channel 32 in this case), and prints the measurement result.

**Code Domain Example Program (HP Instrument BASIC)**

```
20 CLEAR SCREEN
30 OUTPUT Hpib;"*RST"           !Preset the Test Set to a known state.
40 INPUT "Cable DUPLEX OUT to RF IN - press ENTER on controller ",A$
50 OUTPUT Hpib;"DISP CGEN"      !Display the CDMA Generator screen.
60 OUTPUT Hpib;"RFG:FREQ 850 MHZ" !Set the RF Gen Freq to 850 MHz.
70 OUTPUT Hpib;"RFG:AMPL -10 dbm" !Set Amplitude to -10 dBm.
80 OUTPUT Hpib;"CCOM:PATH 'IQ'" !CW RF Path to IQ for CDMA signals.
90 OUTPUT Hpib;"RFG:OUTP 'Dupl'" !Set the Output Port to Duplex.
100 OUTPUT Hpib;"CGEN:DIR 'Fwd'" !Imitate a base station (fwd) channel.
110 OUTPUT Hpib;"DISP CDAN"      !Display the CODE DOMAIN Analyzer screen.
120 OUTPUT Hpib;"RFAN:FREQ 850 MHZ" !Set the Tune Freq.
130 OUTPUT Hpib;"CDAN:MEAS 'POWER'" !Select the Power measurement.
140 OUTPUT Hpib;"CDAN:MARK:POS 32" !Move Marker to Walsh Channel 32.
150 OUTPUT Hpib;"MEAS:CDAN:MARK:LEV?" !Query the marker level.
160 ENTER Hpib;Marker_lev !Enter returned value into a variable.
170 PRINT "Walsh Channel 32 power is =";Marker_lev;"dB"
180 END
```



---

## Data Buffer Operation

The Data Buffer allows you to enter coded CDMA traffic data to test CDMA receivers.

The CDMA Generator's Data Buffer contains separate memory locations for data designated as 9.6 kbps and data designated as 14.4 kbps. Each location can be loaded with up to 1800, 20-millisecond frames of user-defined data.

Data can only be loaded over HP-IB (not the serial or parallel ports). If a program attempts to exceed the 1800-frame limit, the error message **Attempt to load too many frames of data.** will be displayed. The 1800-frame limit can be exceeded by sending a start frame in the fram:load command that is too high for the number of frames being loaded.

After the data is loaded, it can be used as the CDMA Generator's data source by setting the **Data Source** field to **Data Buff**. The **Start Frame** and **# of Frames** fields are used to select which frames of data to output. If these field settings attempt to access frames outside the 1800-frame limit, the error message **Reduce 'Start Frame' or '# of Frames'.** will be displayed when you attempt to send data using the Idle/Send field.

Refer to the "Data Buffer Loading Example" on page 155 for HP-IB command syntax.

## Data Structure

Data is loaded in hexadecimal format, and the number of characters in each frame must be compatible with the selection made in the **Data Rate** field on the CDMA GENERATOR screen.

If the data rate is 9.6 kbps, each frame must contain 48 characters (192 bits) of data. If the data rate is 14.4 kbps, each frame must contain 72 characters (288 bits), with 67 characters used for traffic channel information bits.

---

### NOTE:

---

The data frame length must conform to the selected Data Rate. Refer to the following program example for HP-IB code to specify Data Rate.

Use the following frame structures:

|-- 8 control bits --|-- 172 or 268 traffic channel information bits --|-- 12 tail bits --|

The first 8 bits (2 characters) are used by the reverse traffic channel encoder for control information. Setting the first bit to 1 causes the frame quality indicator to detect an error. A 0 in this bit is interpreted as standard encoding. The seven remaining bits are set to 0.

The next 172 bits (9.6 kbps Data Rate) or 268 bits (14.4 kbps Data Rate) are the reverse traffic channel information bits.

The 12 tail bits (3 characters) can be set to any value.

#### Example of a properly encoded 9.6 kbps frame.

```
00212fb1d55bddd39b6f4c8ddf7bb526d0cccc60dc2edfff
```

#### Example of an encoded 14.4 kbps frame with the first bit set to indicate a frame error.

```
80063d783f58a57b92c34858d57212fb155bddd39b6f4c8ddf7bb526d0cccc60dc  
2edfff
```

Because the first bit is a one (8 = 1000 in binary), the CDMA Generator will output a CRC or frame quality indicator of all zeros. This should generate a frame error detected by the base station.

**Data Buffer  
Loading Example**

This example shows how you could load 300 frames (6 seconds) of random data at a 9.6 kbps data rate. Since the entire program would be several pages long (with 300 lines used for data), this edited example shows the first and last parts of the program. The jump from line 40 to line 3000 omits the remaining 295 lines of frame data loading.

```
10   DIM Test$(300)[60]
20   Test$(1)="cbuf:data '00212fb1d55bdd39b6f4c8ddf7bb526d0cccc60dc2edfff'"
30   Test$(2)="cbuf:data '00de3be21c4862a07e69e91cfe04d6d3fe28a95c67838fff'"
40   Test$(3)="cbuf:data '00fc301c0faaf8dc643c2b44e1511671055ac58cf9343fff'"
3000 Test$(299)="cbuf:data '00647423689398d6db4c844982e986b446ba419abf01ffff'"
3010 Test$(300)="cbuf:data '00210965a147d93ca846661d85cb8fd75ccd59be6a0acfff'"
3020 Hpib=714
3030 Start_frame=0           ! Load data at the specified frame.
3035 OUTPUT Hpib;"cgen:data:rate '9.6 kbps'" ! Specify data rate
3040 OUTPUT Hpib;"cbuf:fram:load "&VAL$(Start_frame)
3050 FOR I=1 TO 300
3060 OUTPUT Hpib;Test$(I)
3070 DISP "Writing frame ",I           !Prompt to display what frame is being loaded.
3080 NEXT I
3090 DISP "Download is done..."
3100 END
```

---

## Status Registers

### **CDMA Status Reporting**

Status reporting is used to communicate the Test Set's current status information to the application program. A description of Status Reporting and its uses can be found in the Programming Manual.

### **Status Register Group Contents**

Figure 12 on page 157 shows the Status Register Groups in the Test Set. For events and errors directly related to CDMA functions performed by the HP 8921 Option 600, the CDMA Status Register #1 Group and the Calibrating Status Register Groups are provided. These register groups are documented in the following sections.

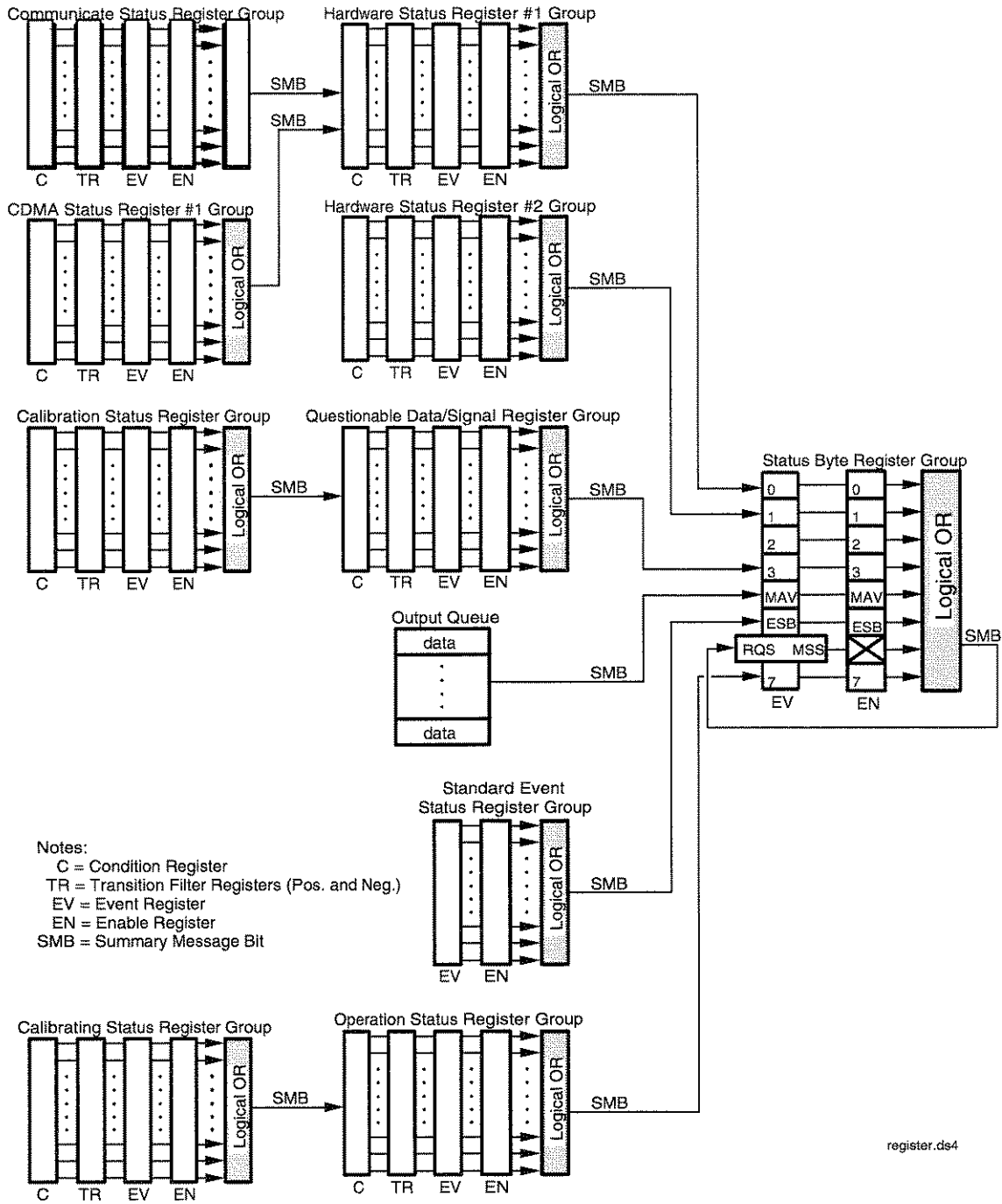

Figure 12 Test Set Status Register Groups

**CDMA Status Register #1 Group**

The CDMA Status Register #1 Group contains information about the state of CDMA measurements. The CDMA Status Register #1 Group uses 16-bit registers and includes a Condition Register, Transition Filters, an Event Register, an Enable Register, and a Summary Message. Figure x shows the structure and STATUS commands for the CDMA Status Register #1 Group.

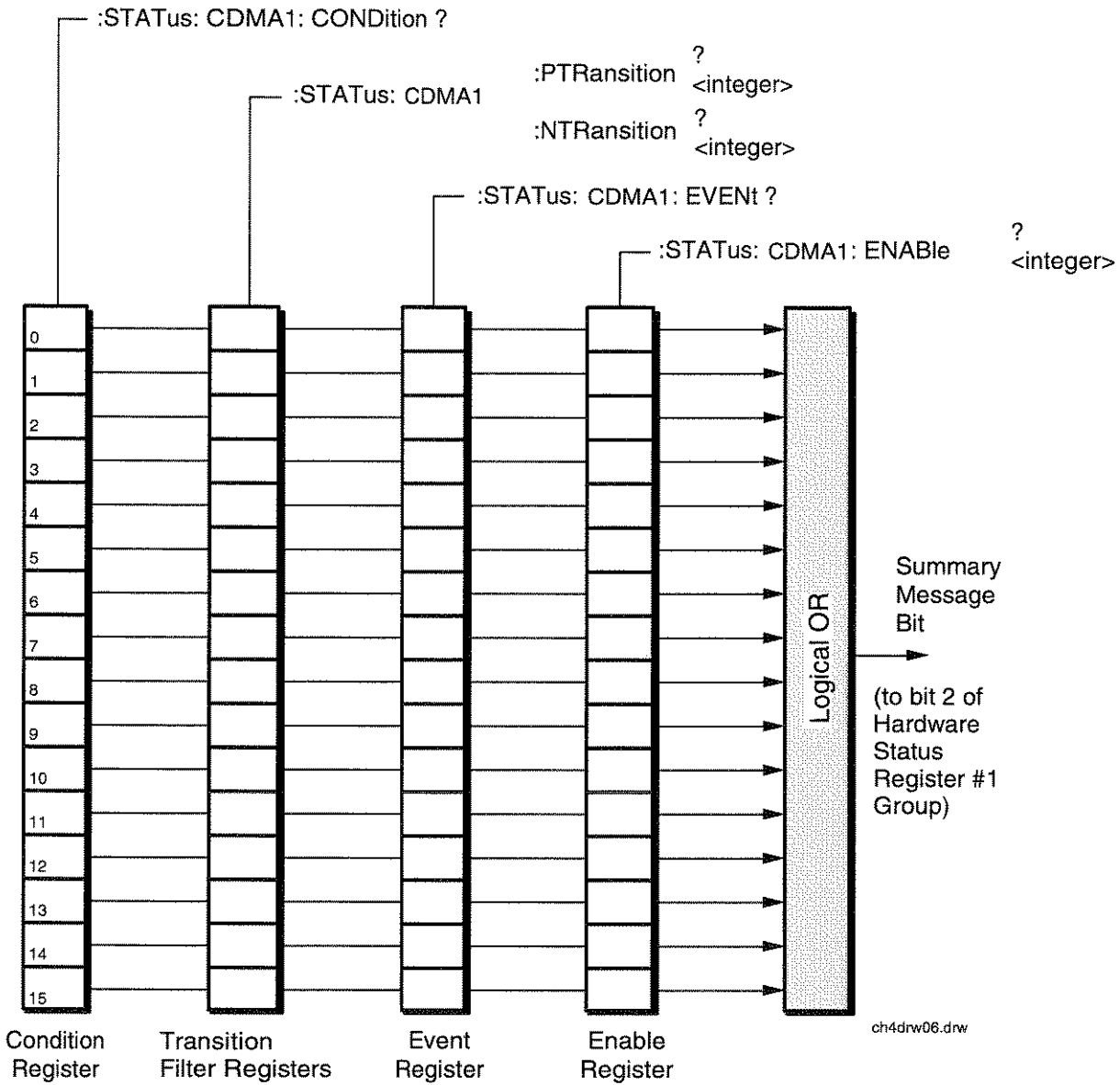

Figure 13 CDMA Status Register #1 Group

**Table 2** CDMA Status Register #1 Group Condition Register Bit Assignments

Bit Number	Binary Weighting	Condition	Comment
15	32768	Unused in the Test Set	
14	16384	Unused in the Test Set	
13	8192	Unused in the Test Set	
12	4096	Unused in the Test Set	
11	2048	Unused in the Test Set	
10	1024	Unused in the Test Set	
9	512	Unused in the Test Set	
8	256	Unused in the Test Set	
7	128	Unused in the Test Set	
6	64	Unused in the Test Set	
5	32	Unused in the Test Set	
4	16	Unused in the Test Set	
3	8	Minimizer error	Poor signal quality. Unable to extract signal.
2	4	Miscellaneous DSP error	DSP error <integer> occurred.
1	2	Can't correlate error	Cannot correlate to input signal. Make sure the even second clock is connected and the correct mode is selected, the PN offset index setting is correct, and the correct references are set (see CDMA TB, PN Offset, and Synth Ref in the CDMA Screens Descriptions).
0	1	ADC overdrive error	Analyzer is overdriven. Reduce signal level or gain.

**Accessing the CDMA Status Register #1 Group's Registers**

The following sections show the syntax and give programming examples, using the HP BASIC programming language, for the STATus commands used to access the CDMA Status Register #1 Group's registers.

#### Reading the Condition Register

##### Syntax

STATus:CDMA1:CONDition?

##### Example

```
OUTPUT 714;"STAT:CDMA1:COND?"  
ENTER 714;Register_value
```

#### Reading the Transition Filters

##### Syntax

STATus:CDMA1:PTRansition?  
STATus:CDMA1:NTRansition?

##### Example

```
OUTPUT 714;"STAT:CDMA1:PTR?"  
ENTER 714;Register_value
```

#### Writing the Transition Filters

##### Syntax

STATus:CDMA1:PTRansition <integer>  
STATus:CDMA1:NTRansition <integer>

##### Example

```
OUTPUT 714;"STAT:CDMA1:PTR 256"
```



#### Reading the Event Register    Syntax

**STATus:CDMA1:EVENT?**

#### Example

**OUTPUT 714;"STAT:CDMA1:EVENT?"**  
**ENTER 714;Register\_value**

#### Clearing the Event Register

The EVENT register is cleared whenever it is queried or whenever the Common Command \*CLS is sent to the Test Set.

#### Reading the Enable Register

##### Syntax

**STATus:CDMA1:ENABLE?**

##### Example

**OUTPUT 714;"STAT:CDMA1:ENAB?"**  
**ENTER 714;Register\_value**

#### Writing the Enable Register

##### Syntax

**STATus:CDMA1:ENABLE <integer>**

##### Example

**OUTPUT 714;"STAT:CDMA1:ENAB 256"**

#### Clearing the Enable Register

The ENABLE register is cleared by writing to it with an integer value of zero.

### Calibrating Status Register Group

The Calibrating Status Register Group contains information about events associated with calibrating CDMA measurements. This register group uses 16-bit registers and includes a Condition Register, Transition Filters, an Event Register, an Enable Register, and a Summary Message. Figure x shows the structure and STATus commands for the Calibrating Status Register Group.

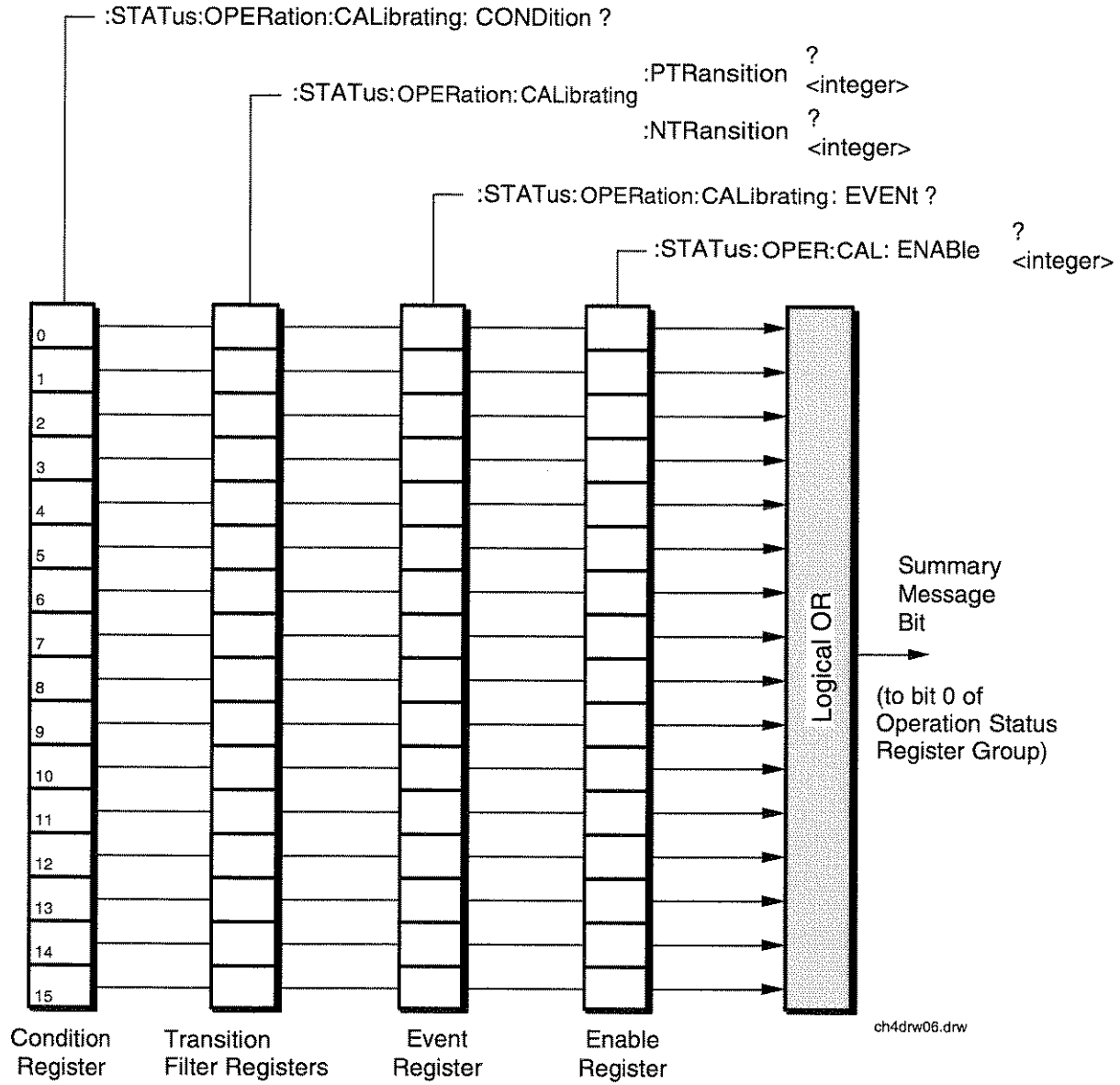

**Figure 14** Calibrating Status Register Group

**Table 3**                      **Calibrating Status Register Group Condition Register Bit Assignments**

<b>Bit Number</b>	<b>Binary Weighting</b>	<b>Condition</b>	<b>Comment</b>
15	32768	Unused in the Test Set	
14	16384	Unused in the Test Set	
13	8192	Unused in the Test Set	
12	4096	Unused in the Test Set	
11	2048	Unused in the Test Set	
10	1024	Unused in the Test Set	
9	512	Unused in the Test Set	
8	256	Unused in the Test Set	
7	128	Unused in the Test Set	
6	64	Unused in the Test Set	
5	32	Unused in the Test Set	
4	16	Unused in the Test Set	
3	8	Unused in the Test Set	
2	4	Unused in the Test Set	
1	2	Channel power calibration	Calibrating Channel Power
0	1	Digital power zeroing	Zeroing Average Power

**Accessing the Calibrating Status Register Group's Registers**

The following sections show the syntax and give programming examples, using the HP BASIC programming language, for the STATus commands used to access the Calibrating Status Register Group's registers.

#### Reading the Condition Register

##### Syntax

**STATus:OPERation:CALibrating:CONDition?**

##### Example

```
OUTPUT 714;"STAT:OPERation:CALibrating:COND?"  
ENTER 714;Register_value
```

#### Reading the Transition Filters

##### Syntax

**STATus:OPERation:CALibrating:PTRansition?**  
**STATus:OPERation:CALibrating:NTRansition?**

##### Example

```
OUTPUT 714;"STAT:OPERation:CALibrating:PTR?"  
ENTER 714;Register_value
```

#### Writing the Transition Filters

##### Syntax

**STATus:OPERation:CALibrating:PTRansition <integer>**  
**STATus:OPERation:CALibrating:NTRansition <integer>**

##### Example

```
OUTPUT 714;"STAT:OPERation:CALibrating:PTR 256"
```

#### Reading the Event Register    Syntax

**STATus:OPERation:CALibrating:EVENT?**

#### Example

**OUTPUT 714;"STAT:OPERation:CALibrating:EVENT?"**  
**ENTER 714;Register\_value**

#### Clearing the Event Register

The EVENT register is cleared whenever it is queried or whenever the Common Command \*CLS is sent to the Test Set.

#### Reading the Enable Register

##### Syntax

**STATus:OPERation:CALibrating:ENABLE?**

#### Example

**OUTPUT 714;"STAT:OPERation:CALibrating:ENAB?"**  
**ENTER 714;Register\_value**

#### Writing the Enable Register

##### Syntax

**STATus:OPERation:CALibrating:ENABLE <integer>**

#### Example

**OUTPUT 714;"STAT:OPERation:CALibrating:ENAB 256"**

#### Clearing the Enable Register

The ENABLE register is cleared by writing to it with an integer value of zero.

### Calibration Status Register Group

The Calibration Status Register Group contains information about errors that can occur during calibration. Refer to the Test Set's Programmer's Guide for a complete description of the Calibration Status Register Group.

This register group uses 16-bit registers and includes a Condition Register, Transition Filters, an Event Register, an Enable Register, and a Summary Message. Figure 15 shows the structure and STATus commands for the Calibration Status Register Group.

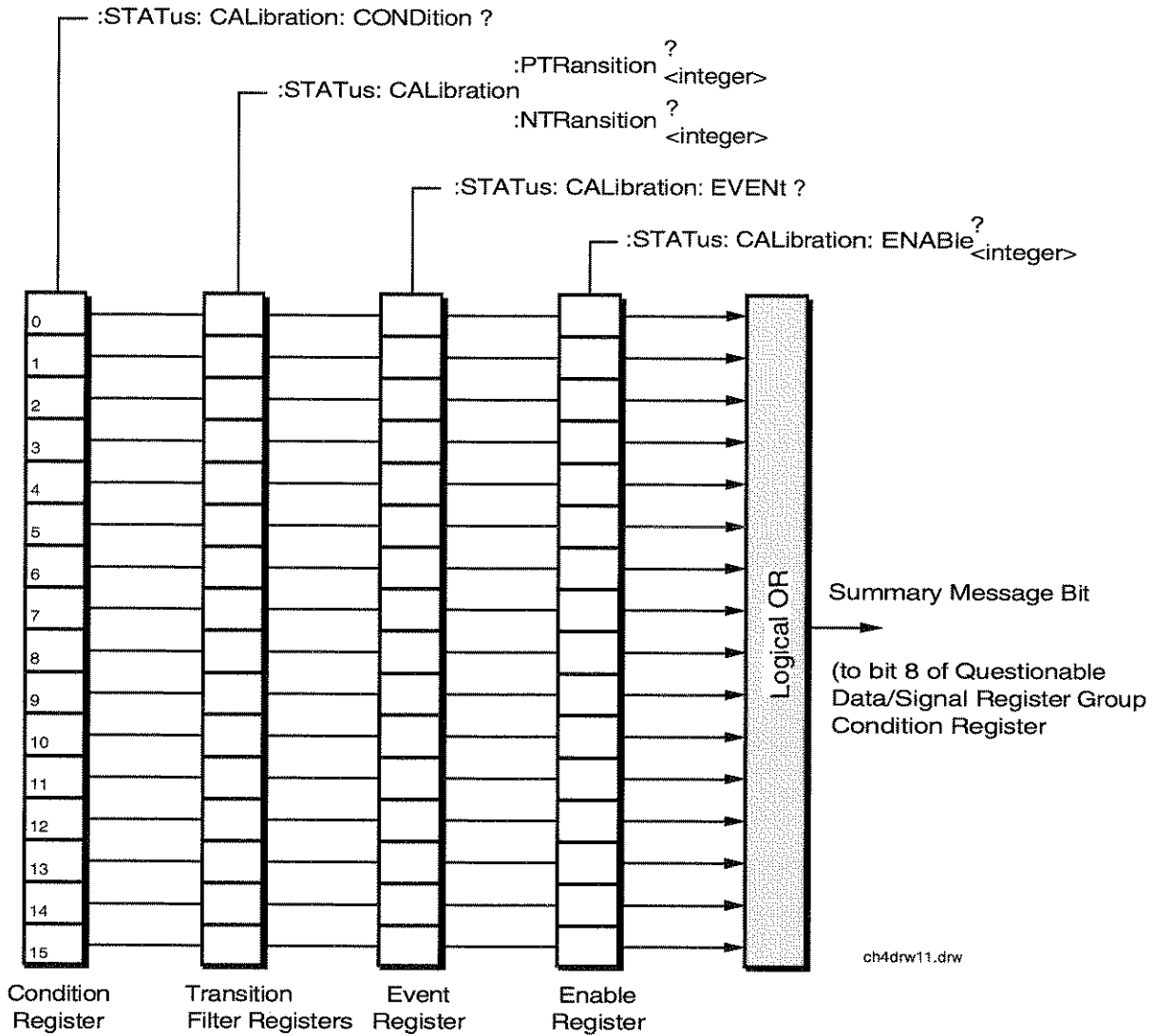

**Figure 15** Calibration Status Register Group

**Table 4 Calibration Status Register Group Condition Register Bit Assignments**

Bit Number	Binary Weighting	Condition	Comment
7	128	Channel power port error	Set Input Port to 'RF In' to calibrate.
6	64	Channel power calibration error	Input power is out of bounds. Check level into analyzer.
5	32	Digital Power zero error	Zero degraded. Reduce generator level for best results.

**Accessing the Calibration Status Register Group's Registers**

The following sections show the syntax and give programming examples, using the HP BASIC programming language, for the STATus commands used to access the Calibrating Status Register Group's registers.

**Reading the Condition Register**

**Syntax**

**STATus:CALibration:CONDition?**

**Example**

```
OUTPUT 714;"STAT:CAL:COND?"
ENTER 714;Register_value
```

**Reading the Transition Filters**

**Syntax**

**STATus:CALibration:PTRansition?**  
**STATus:CALibration:NTRansition?**

**Example**

```
OUTPUT 714;"STAT:CAL:PTR?"
ENTER 714;Register_value
```

### Writing the Transition Filters

#### Syntax

```
STATus:CALibration:PTRansition <integer>  
STATus:CALibration:NTRansition <integer>
```

#### Example

```
OUTPUT 714;"STAT:CAL:PTR 256"
```

### Reading the Event Register Syntax

```
STATus:CALibration:EVENT?
```

#### Example

```
OUTPUT 714;"STAT:CAL:EVENT?"  
ENTER 714;Register_value
```

### Clearing the Event Register

The EVENT register is cleared whenever it is queried or whenever the Common Command \*CLS is sent to the Test Set.

### Reading the Enable Register

#### Syntax

```
STATus:CALibration:ENABle?
```

#### Example

```
OUTPUT 714;"STAT:CAL:ENAB?"  
ENTER 714;Register_value
```

### Writing the Enable Register

#### Syntax

```
STATus:CALibration:ENABle <integer>
```

#### Example

```
OUTPUT 714;"STAT:CAL:ENAB 256"
```

### Clearing the Enable Register

The ENABLE register is cleared by writing to it with an integer value of zero.



---

## HP-IB Syntax Diagrams

These diagrams should be used in conjunction with the command syntax listing in the Test Set's User's Guide.

### HP-IB Command Syntax Diagram Listing

- "CDMA ANalyzer (CANaylzer) Setting Syntax" on page 171.
- "CDMA Data Buffer (CBuffer) Setting Syntax" on page 175.
- "CDMA Common (COMmon) Setting Syntax" on page 176.
- "Code Domain Analyzer (CDANalyzer) Setting Syntax" on page 177.
- "CDMA Generator (CGENERator) Setting Syntax" on page 180.
- "Real Number Setting Syntax" on page 181.
- "Multiple Real Number Setting Syntax" on page 182.
- "MEASure Query Setting Syntax" on page 183.
- "Number Measurement Syntax" on page 186.

**Diagram Conventions**

Use the following diagram to see the conventions used in the syntax diagrams.

Statement elements are connected by lines. Each line can be followed in only one direction, as indicated by the arrow at the end of the line. Any combination of statement elements that can be generated by starting at the root element and following the line the proper direction is syntactically correct. An element is optional if there is a path around it. The drawings show the proper use of spaces. Where spaces are required they are indicated by a hexagon with the word "space" in it, otherwise no spaces are allowed between statement elements.

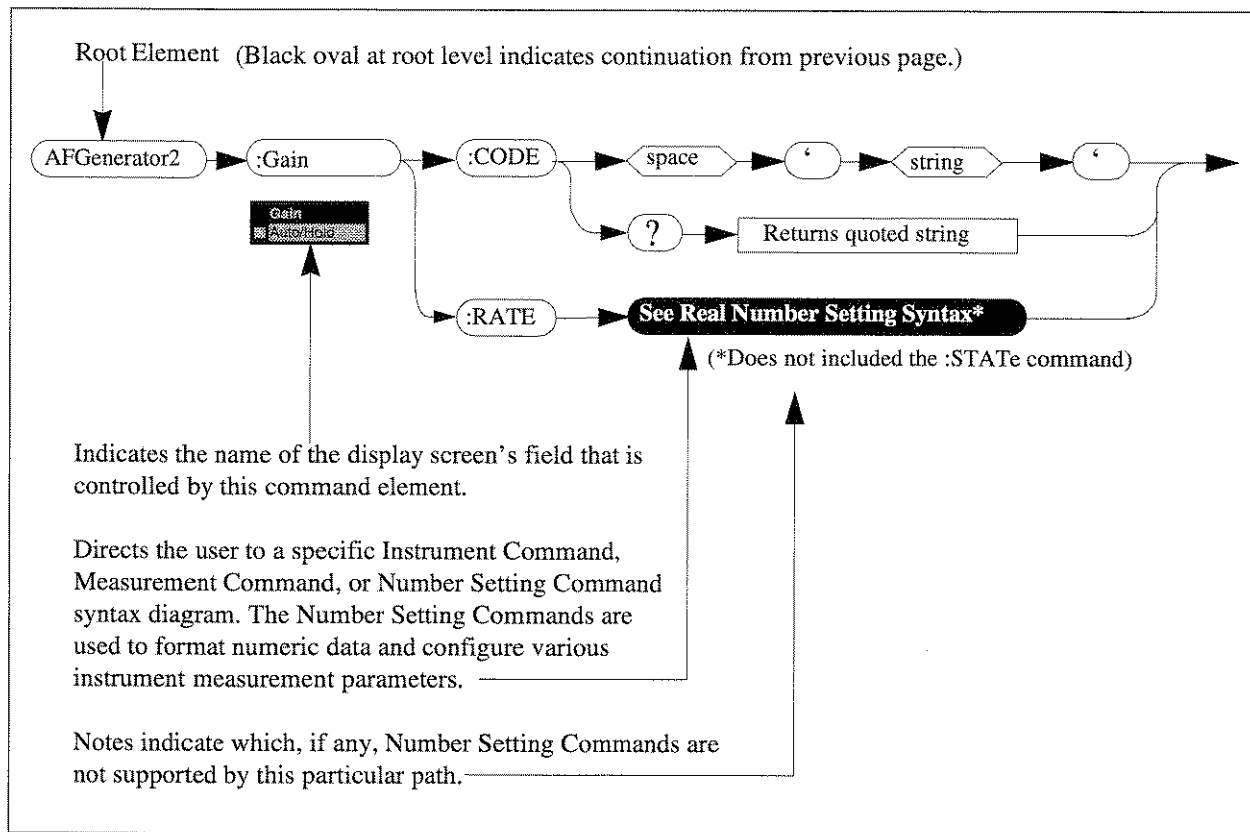

### CDMA Analyzer (CANalyzer) Setting Syntax

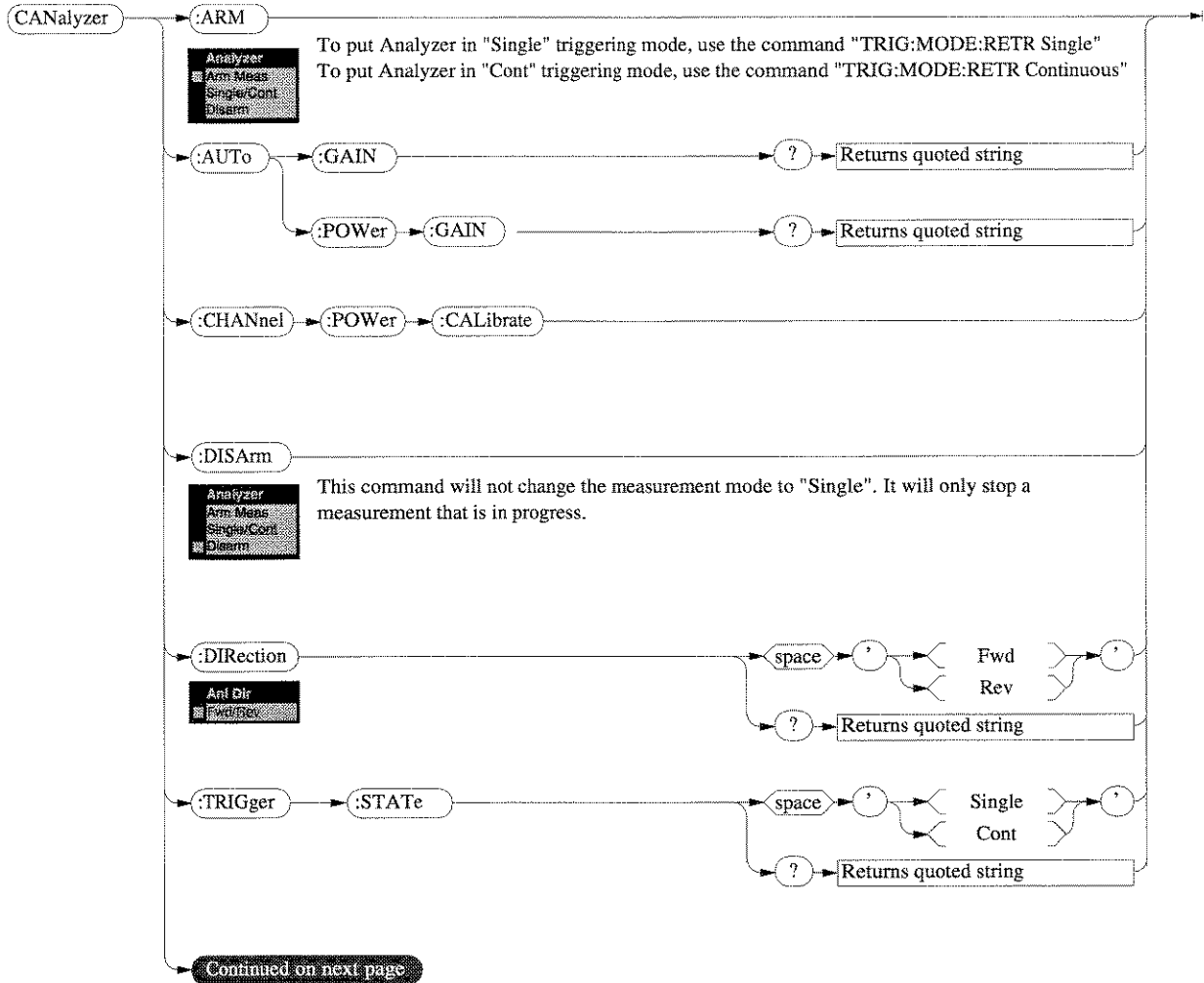

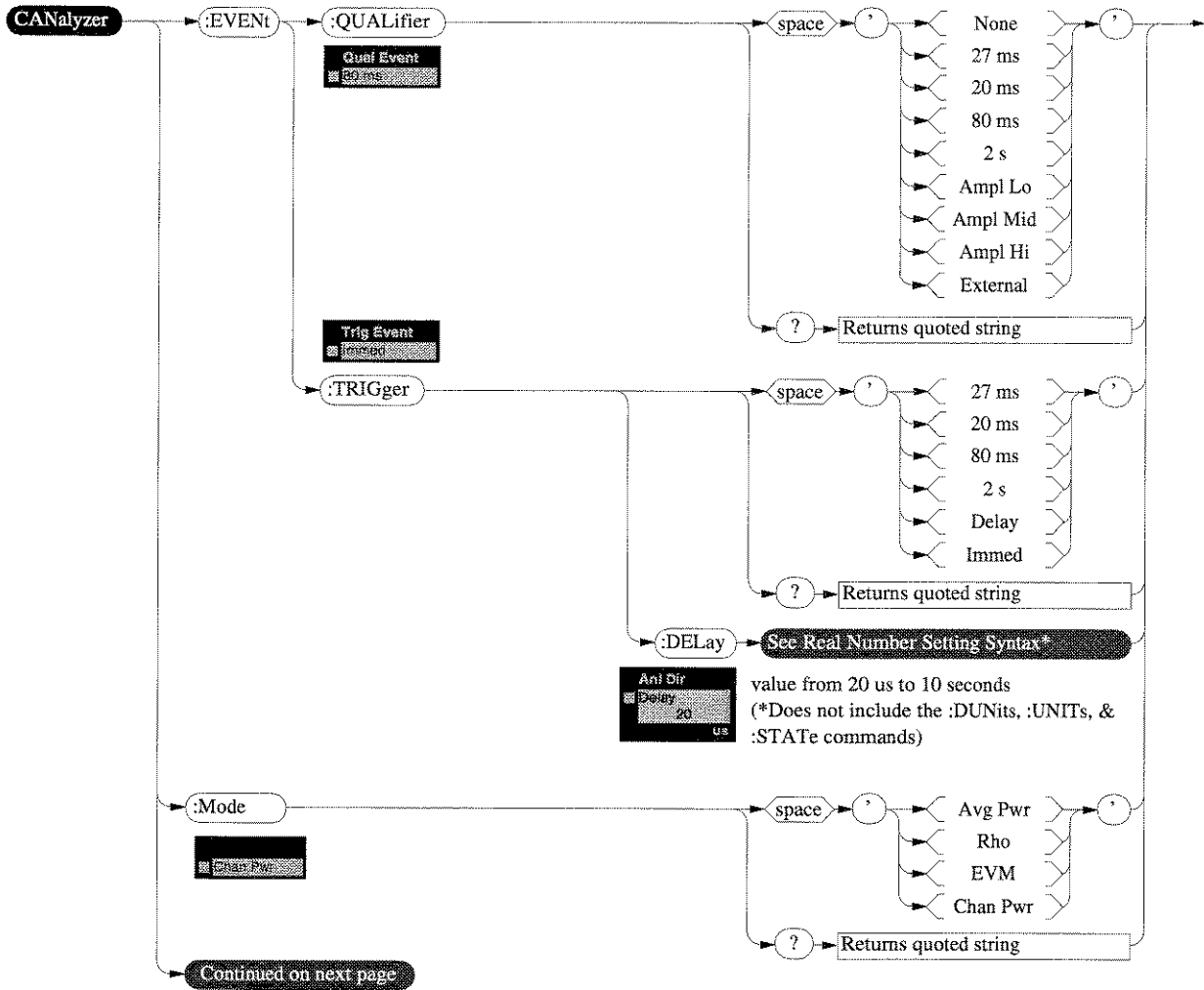

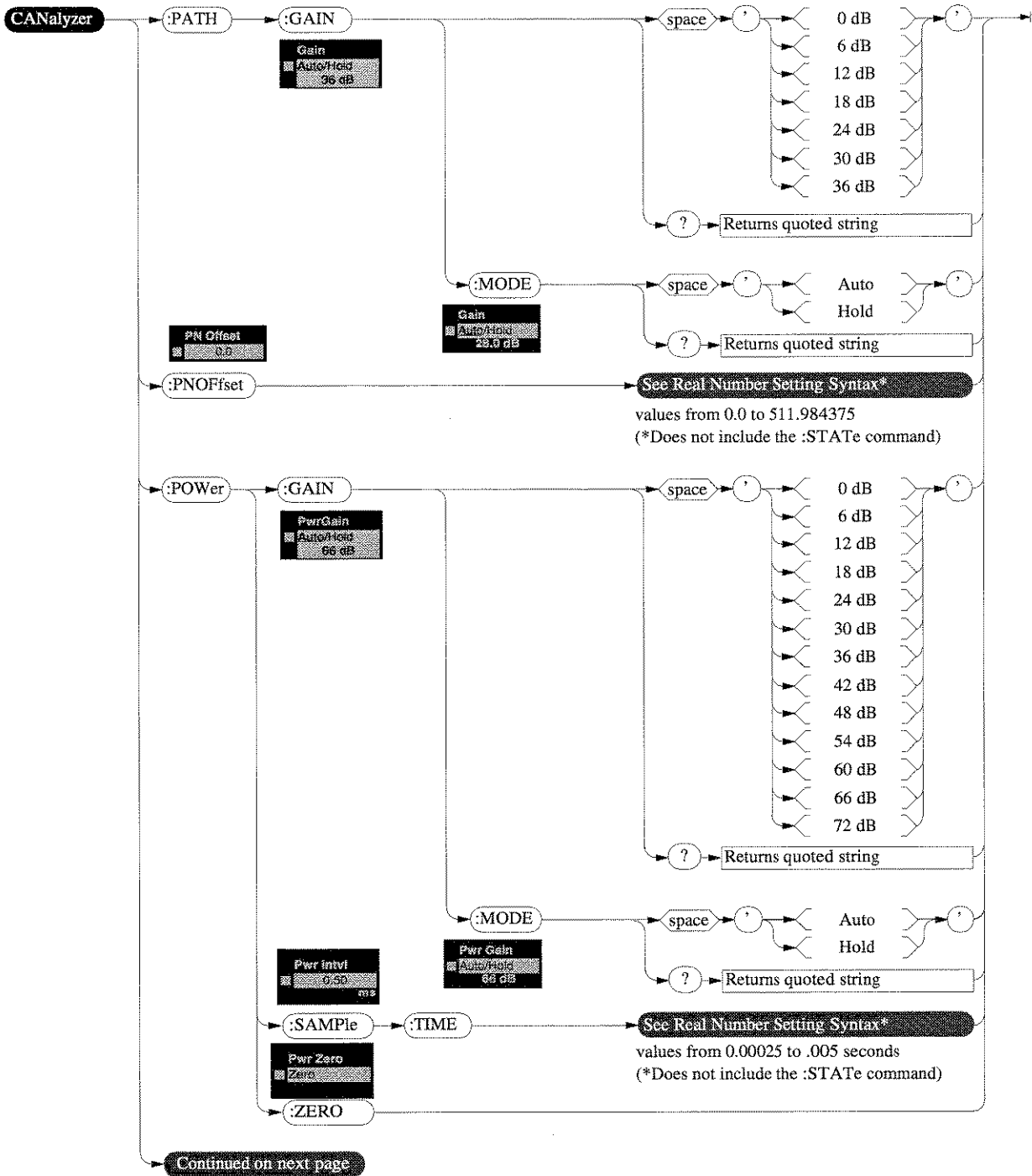

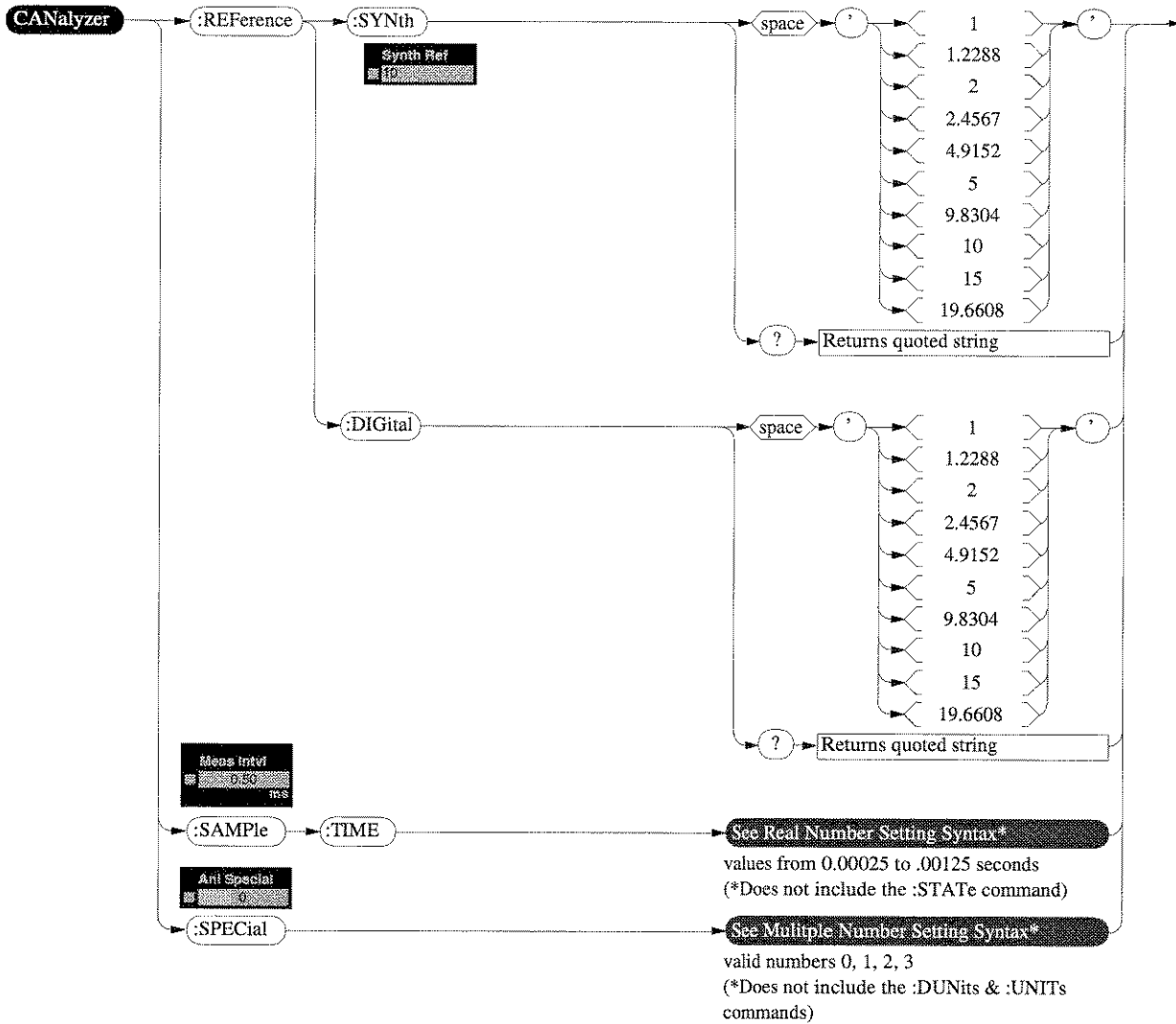

### CDMA Data Buffer (CBuffer) Setting Syntax

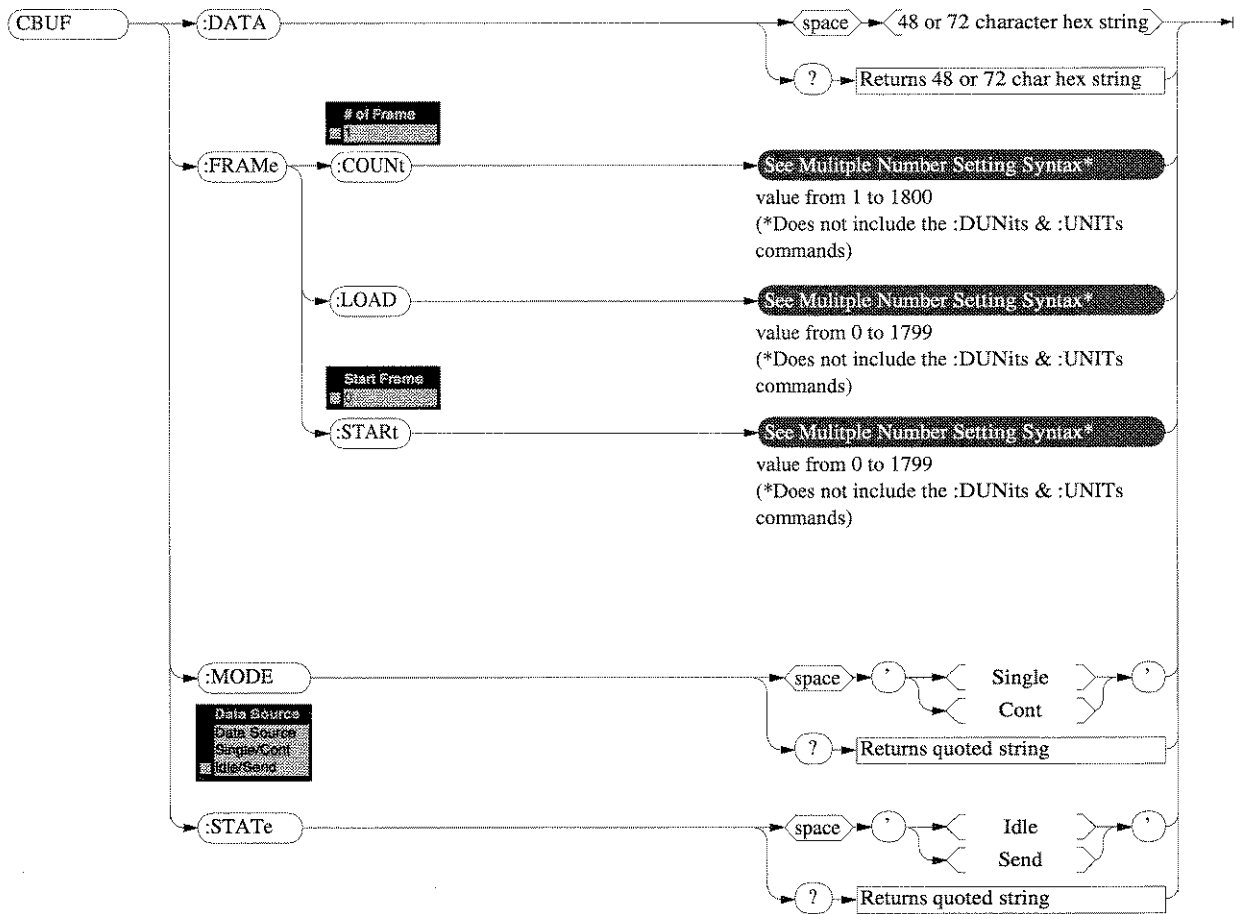

### CDMA Common (COMmon) Setting Syntax





Code Domain Analyzer (CDAnalyzer) Setting Syntax

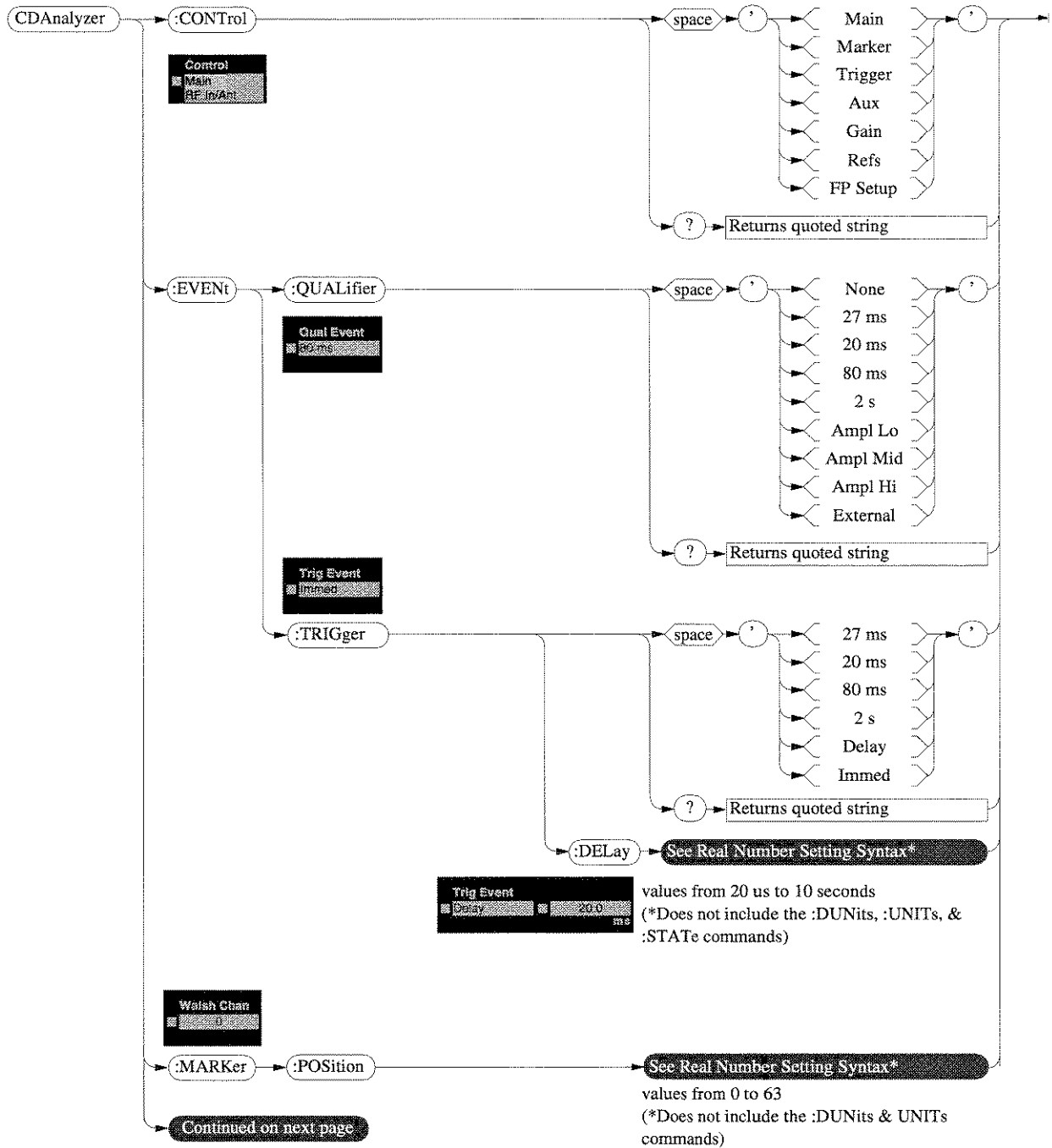

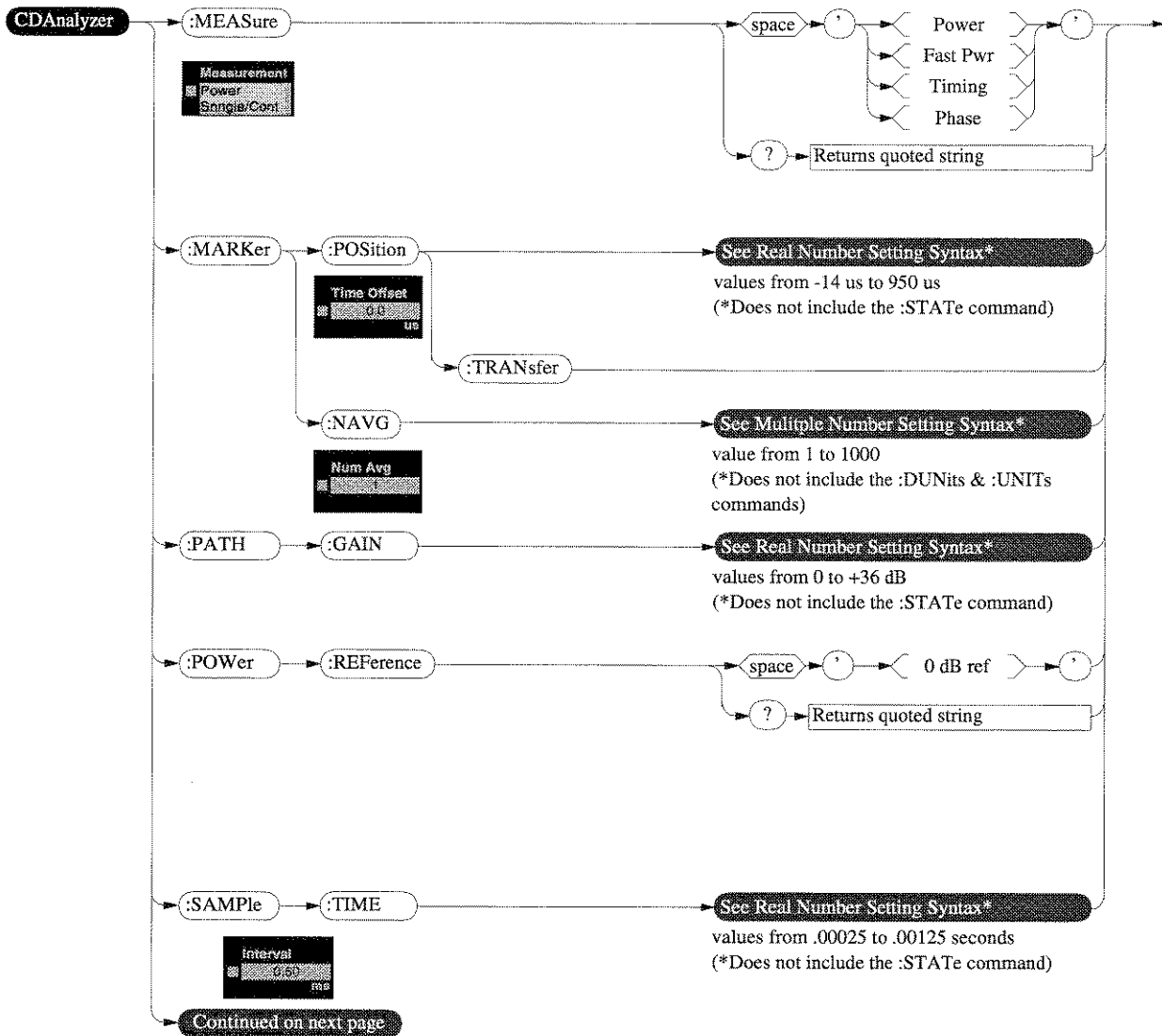

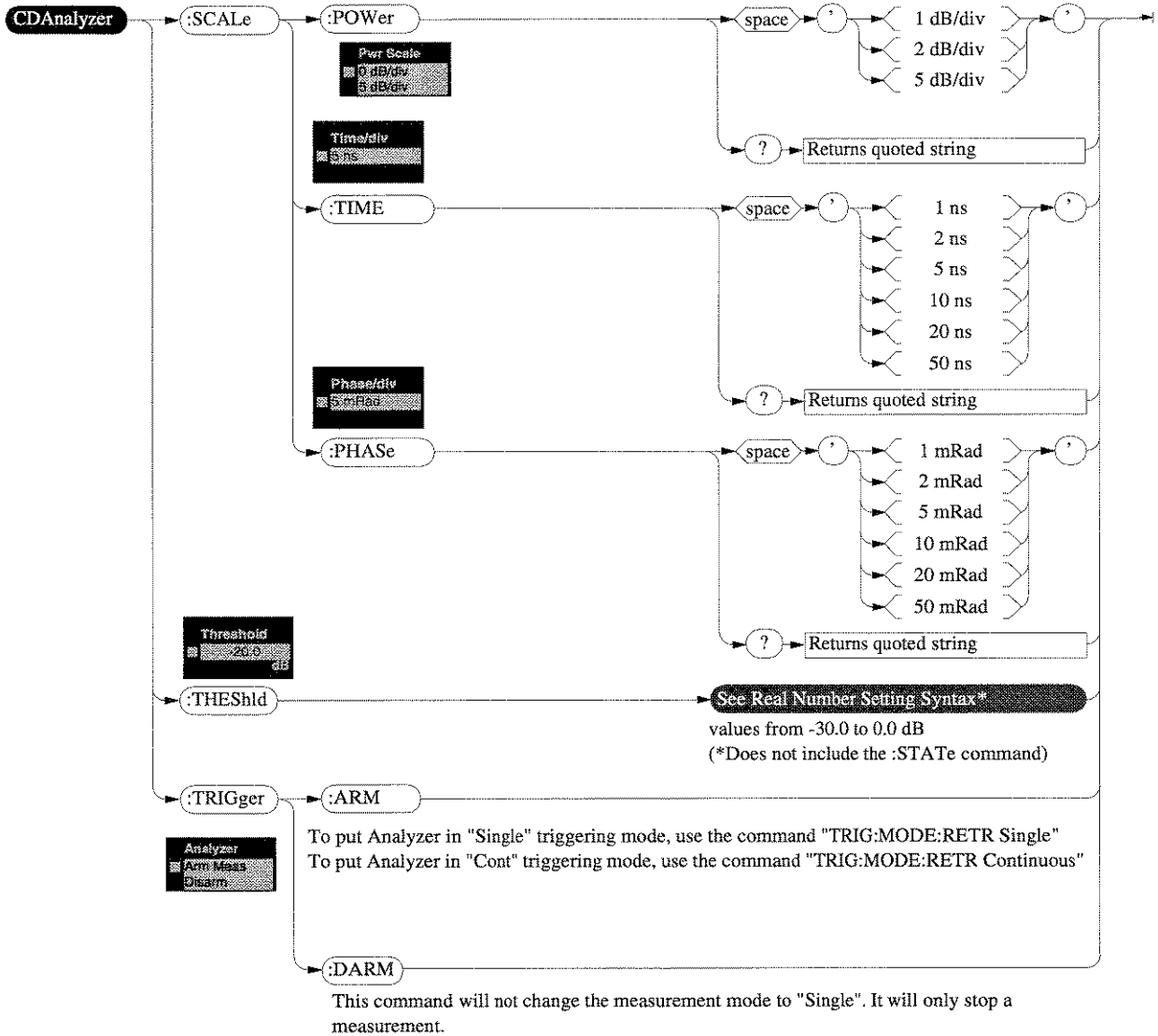

### CDMA Generator (CGENERator) Setting Syntax

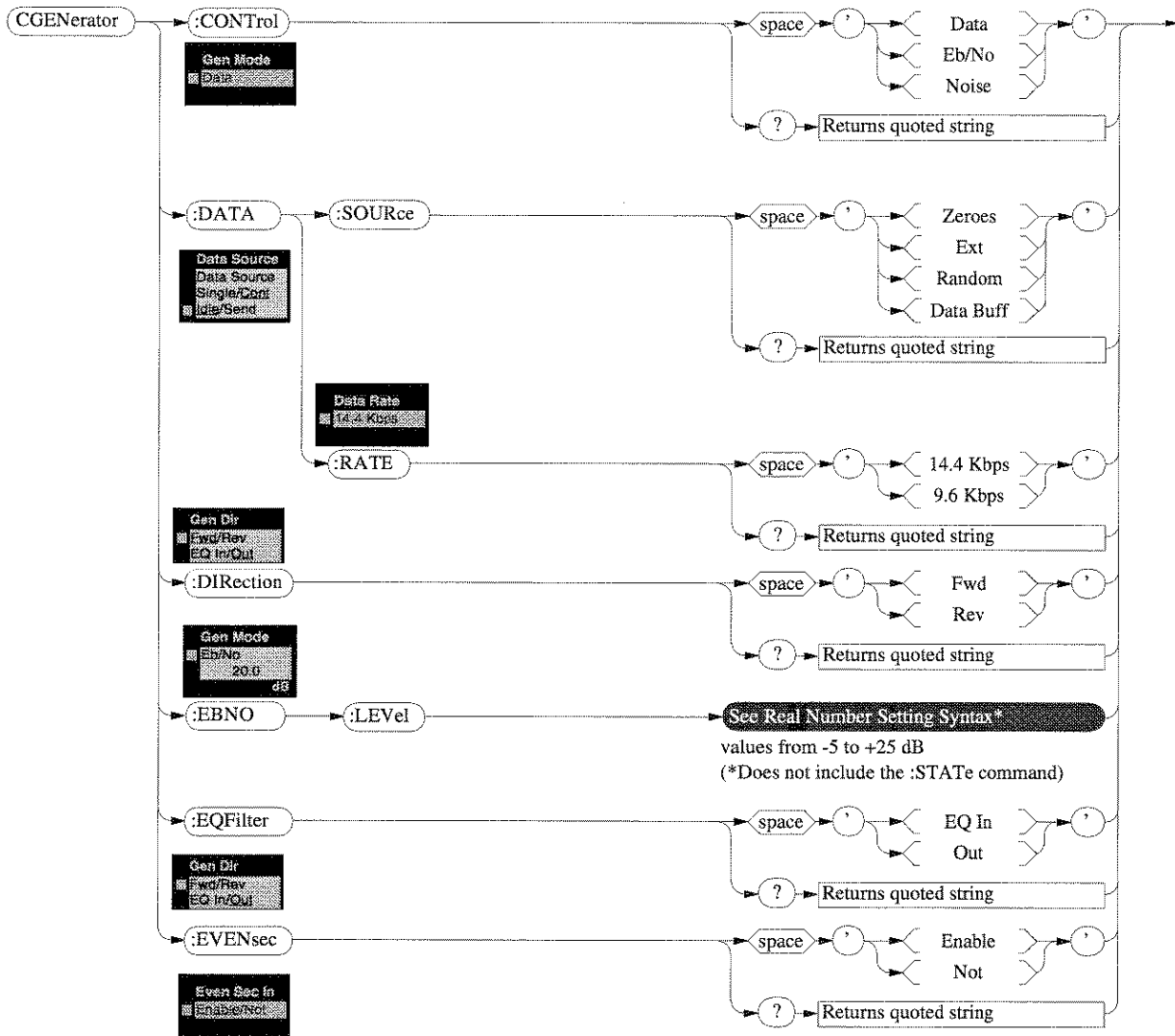

### Real Number Setting Syntax

This is a duplicate of the syntax diagram in the Test Set's User's Guide.

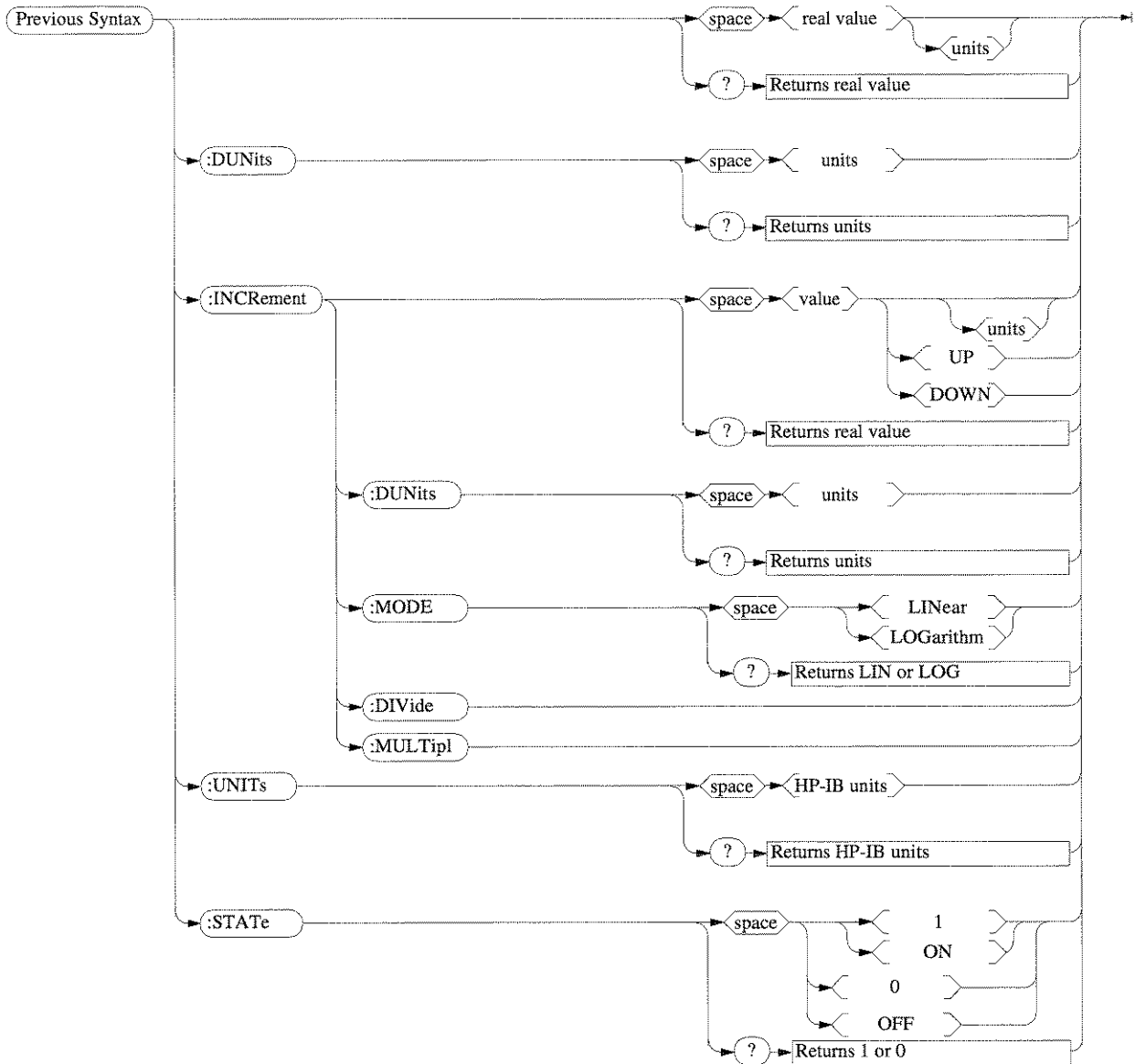

### Multiple Real Number Setting Syntax

This is a duplicate of the syntax diagram in the Test Set's User's Guide.

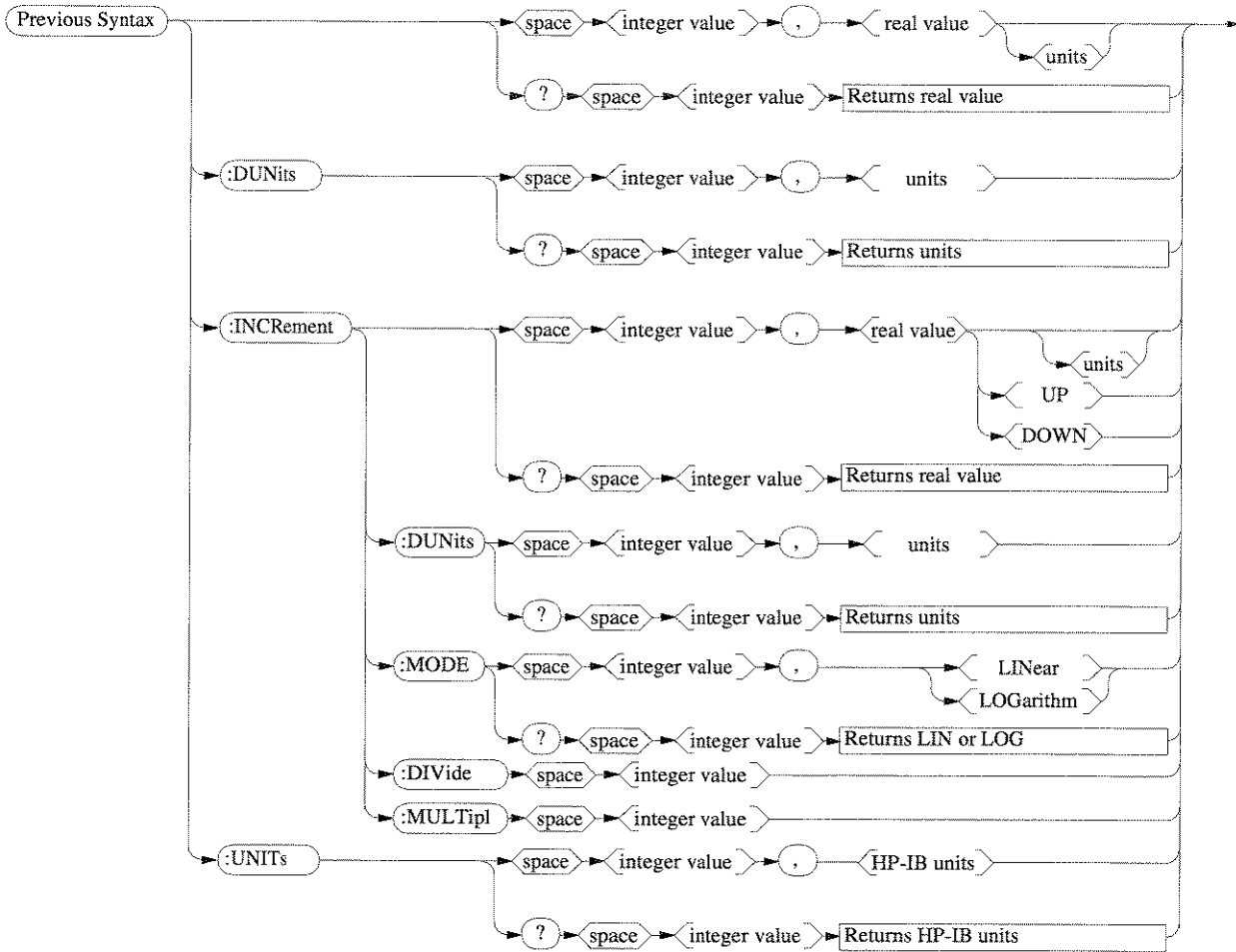

### MEASure Query Setting Syntax

This is only a portion of the syntax diagram in the Test Set's User's Guide.

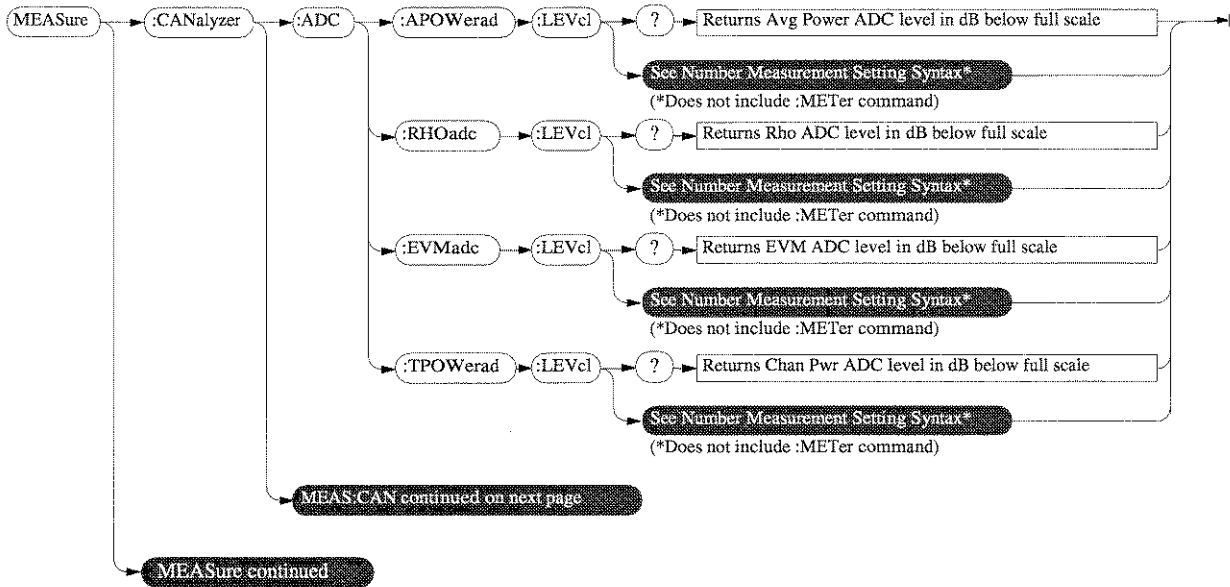

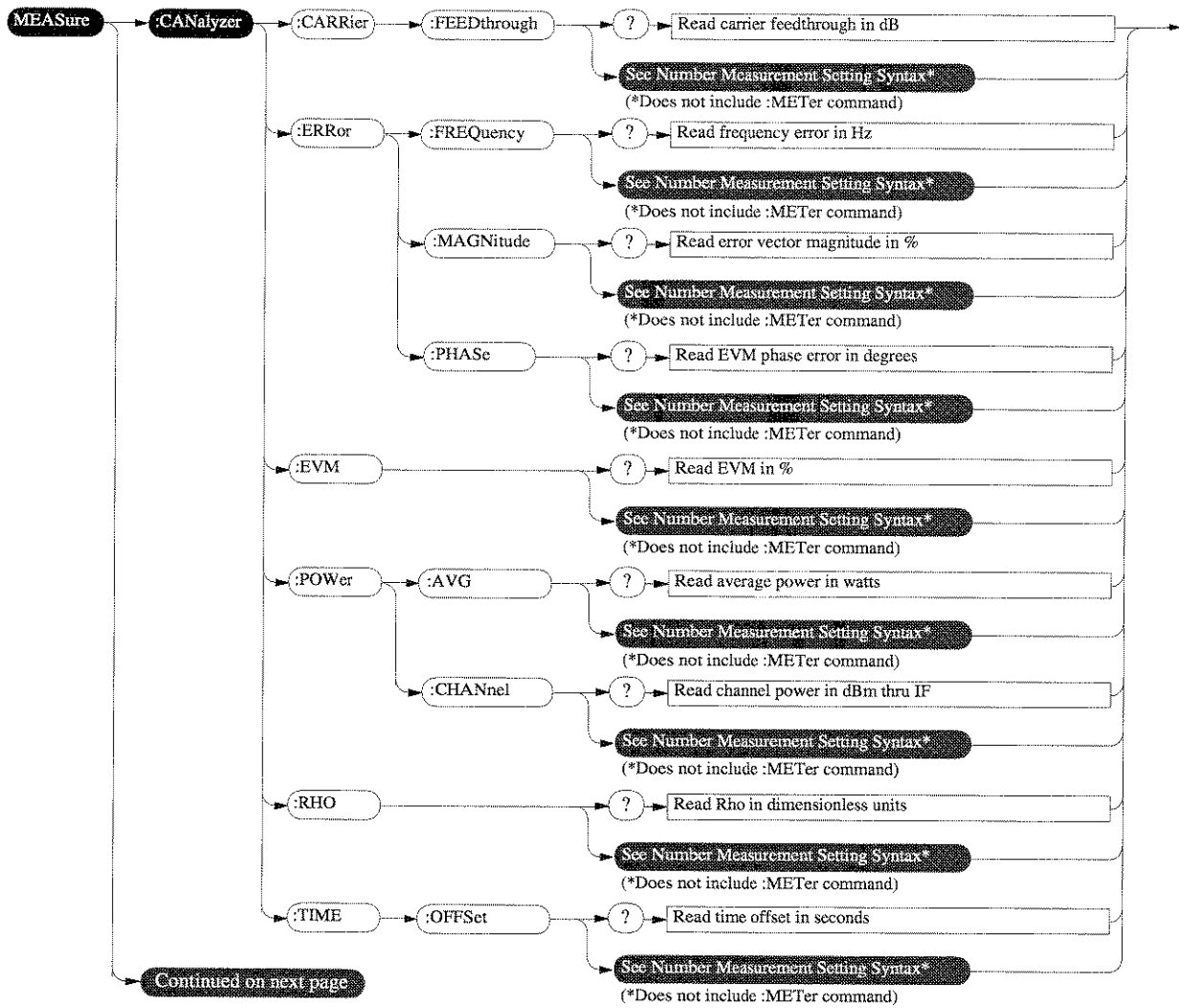



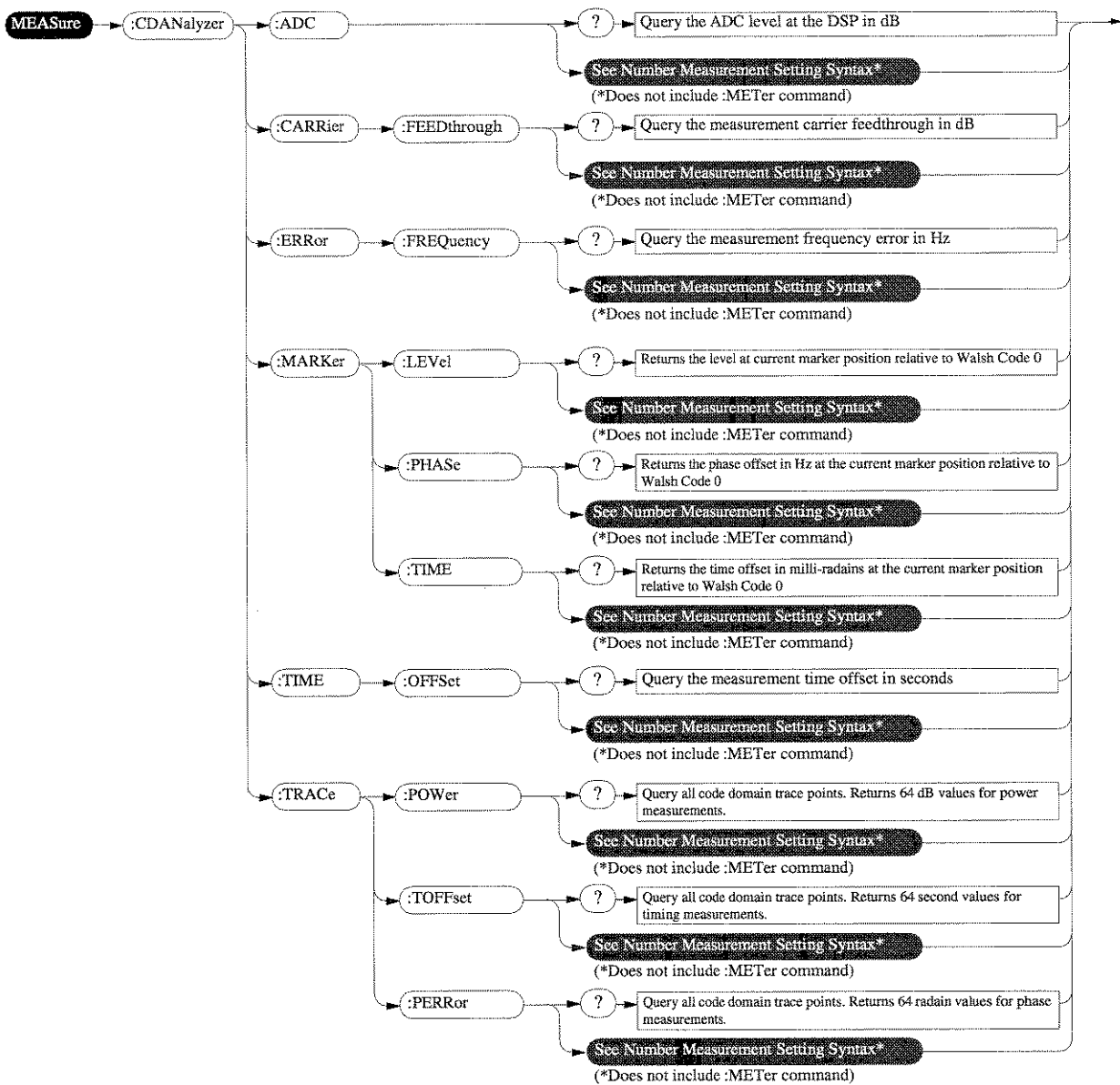

### Number Measurement Syntax

This is a duplicate of the syntax diagram in the Test Set's User's Guide.

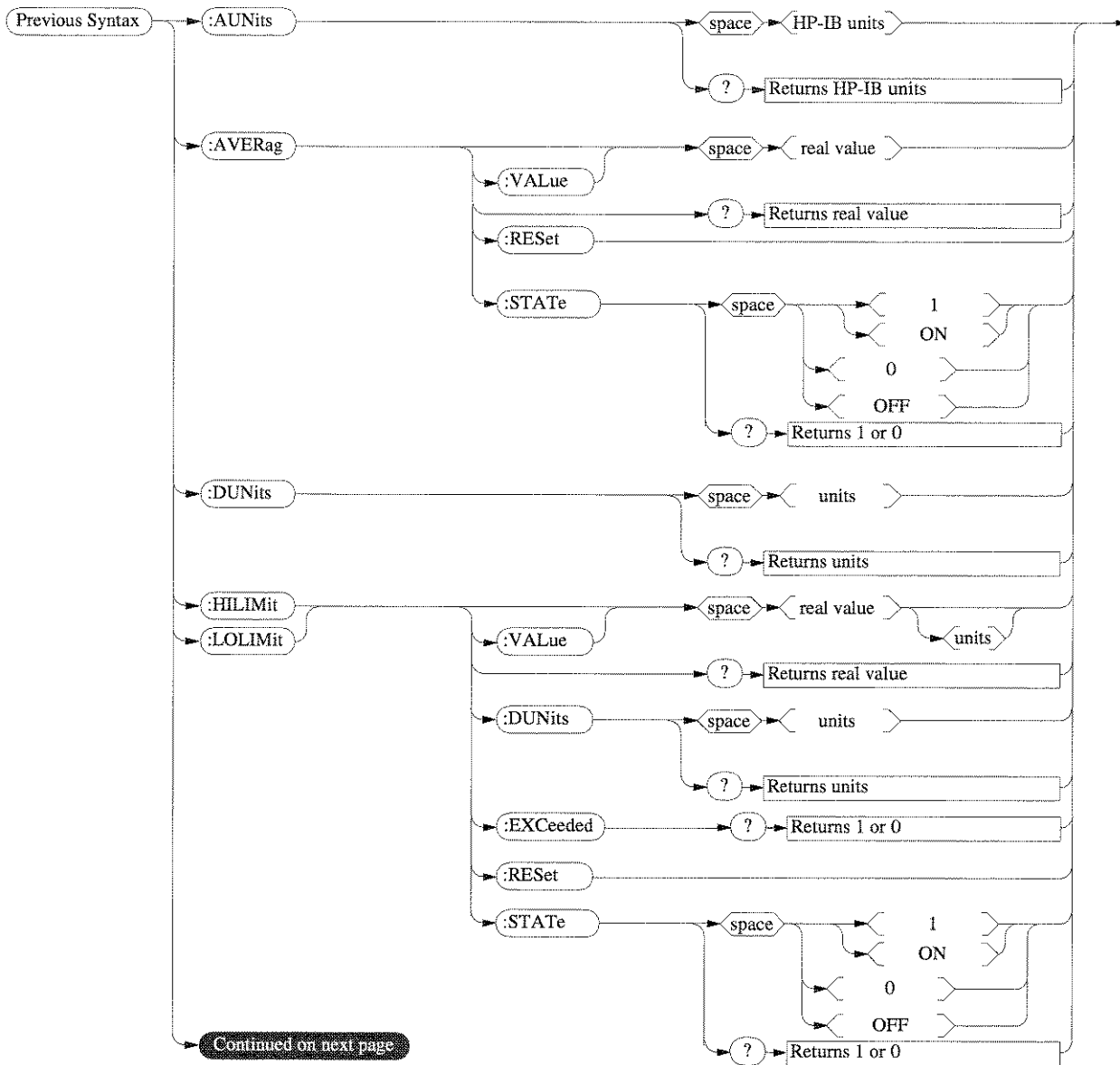

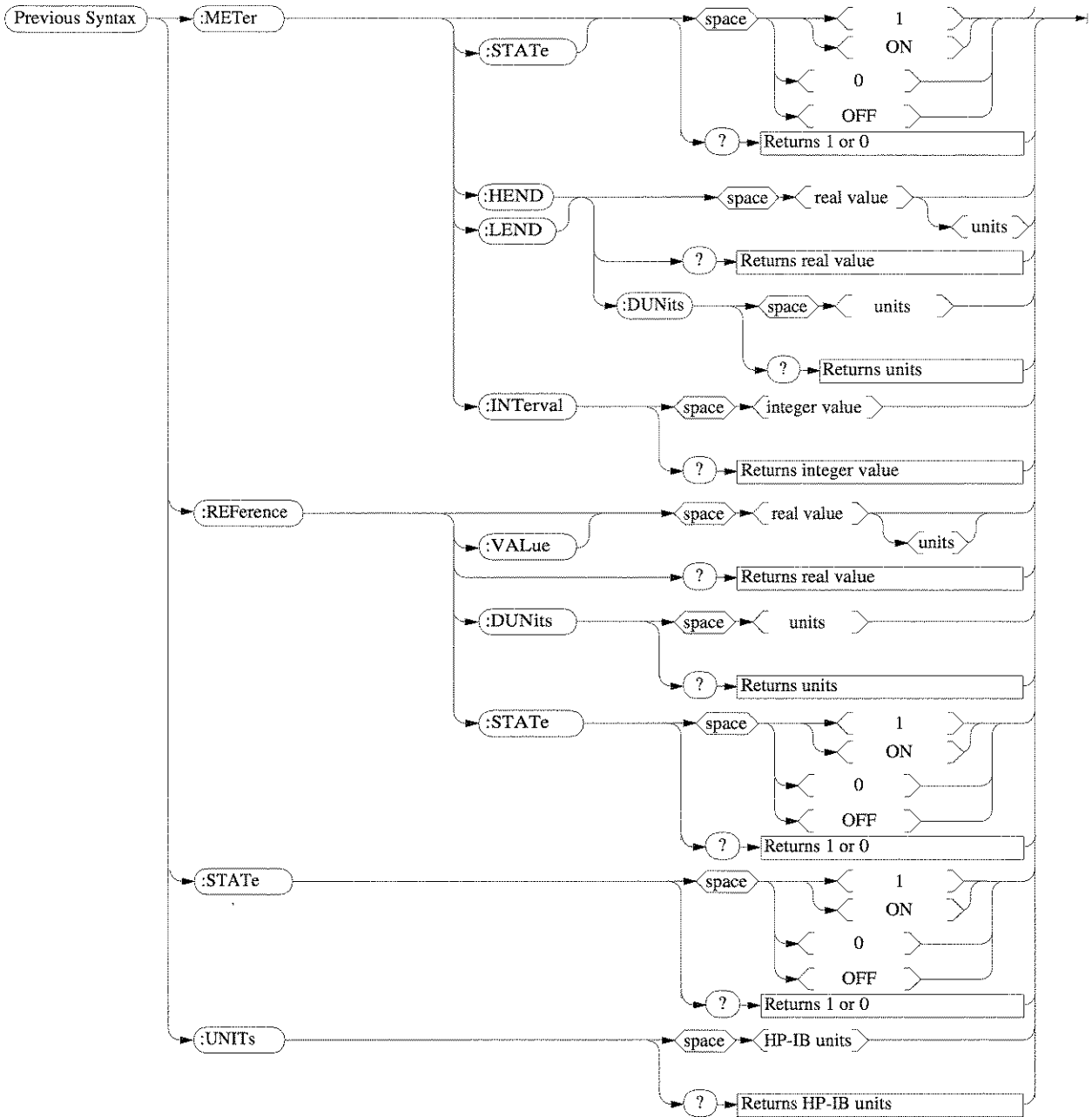



---

## Theory of Operation

## The Instruments

### The Cellular Adapter

- Downconverts the 114.3 MHz IF input from the Test Set to a second IF of 3.6864 MHz.
- Digitizes and analyzes the 3.6864 MHz IF signal.
- Receives a CW (unmodulated) RF signal from the Test Set.
- Generates a CDMA spread spectrum signal centered around the Test Set's RF generator frequency setting. An internal data buffer and noise generator provides signals for receiver testing.
- Provides IQ modulation from an internal pilot PN sequence generator or from an external source (through the Data In connector).
- Generates CDMA frame clocks which are used to trigger measurements.
- Accepts reference frequencies which are used to lock the instrument's pilot PN sequence generator, CDMA frame clocks, and downconverter to an external frequency.
- Accepts Even Second Clock signals used to synchronize the base station's CDMA signals to the Cellular Adapter.

- The HP 8921A**
- Receives a CDMA modulated RF signal.
  - Adjusts the level of the received CDMA signal.
  - Downconverts the base station's CDMA channel frequency to 114.3 MHz and outputs the downconverted signal to the Cellular Adapter.
  - Controls the Cellular Adapter over a digital interface cable.
  - Generates a CW signal that is sent to the Cellular Adapter for CDMA modulation.
  - Controls the frequency and amplitude of the generated CDMA signal.
  - Transmits the CDMA signal out the RF IN/OUT or DUPLEX OUT connector.
  - Provides a spectrum analyzer for looking at the base station's transmitted signal.

Chapter 7, Theory of Operation  
The Instruments

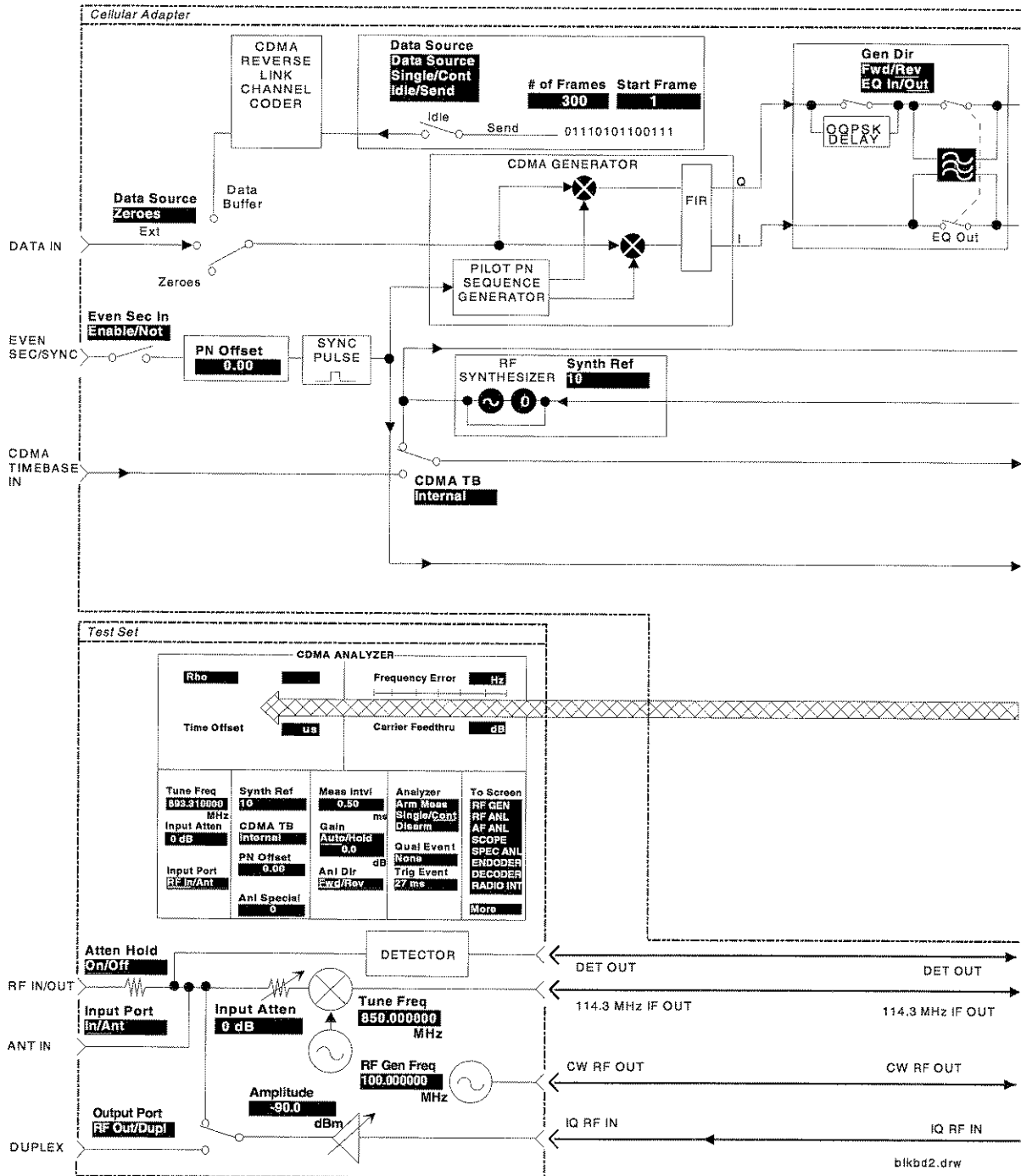



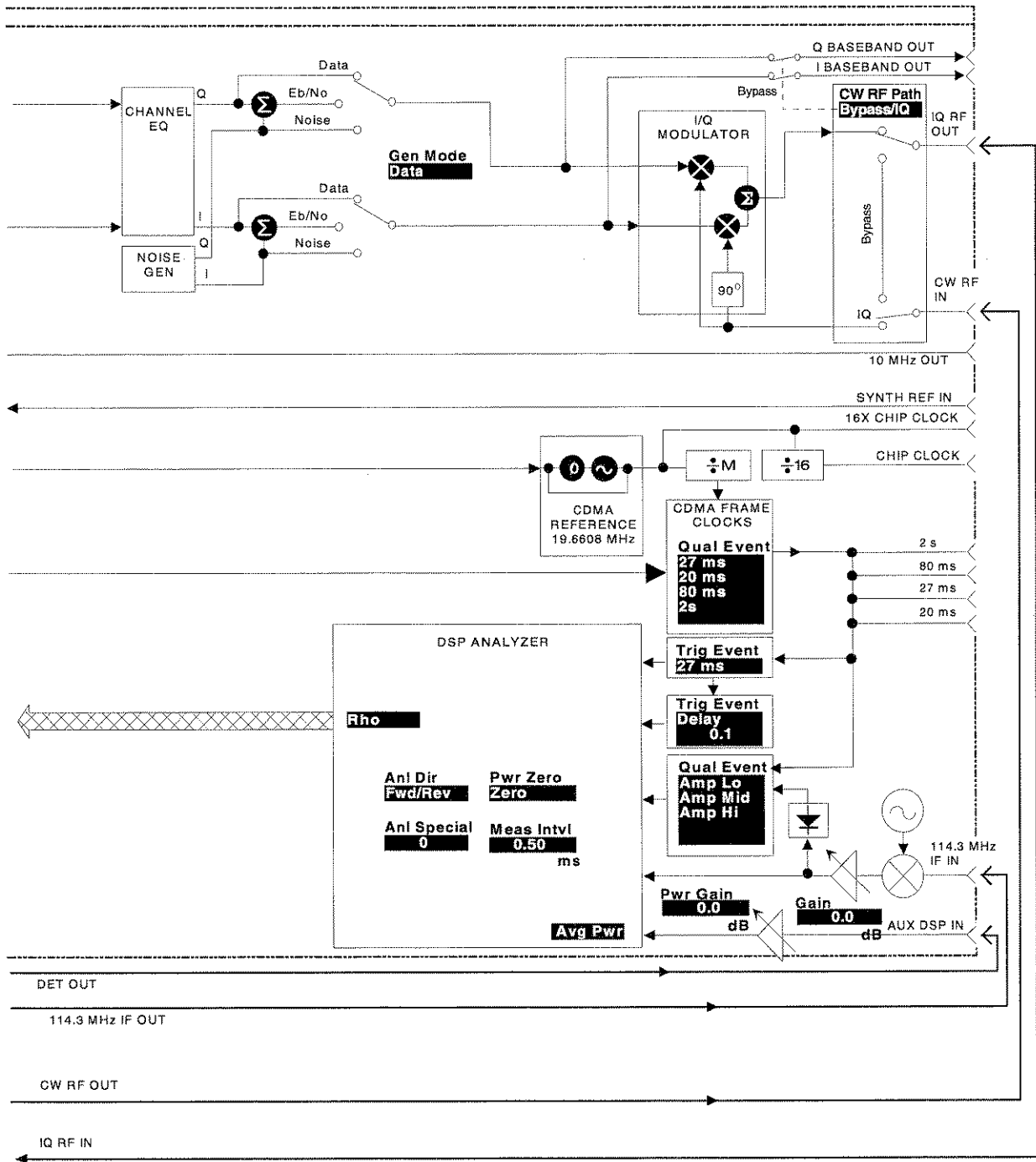

blkbd3.ds4

---

## Timing Diagrams

### Frame Clock Timing

The following diagram shows the timing relationship between the sync pulse and the 27 ms CDMA frame clock. The 20 ms, 80 ms, and 2 second CDMA frame clocks are all re-synchronized when a sync pulse occurs.

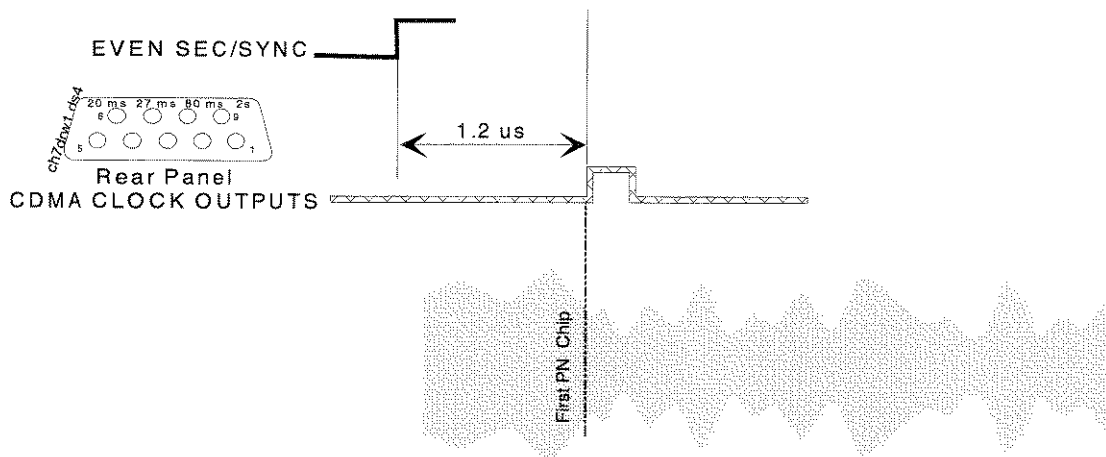

### Pilot PN Sequence Timing

The following diagram shows the timing relationship between the 27 ms CDMA frame clock and the first chip of each pilot PN sequence at the Test Set's RF IN/OUT port. The **PN Offset** field is set to its default value of zero.

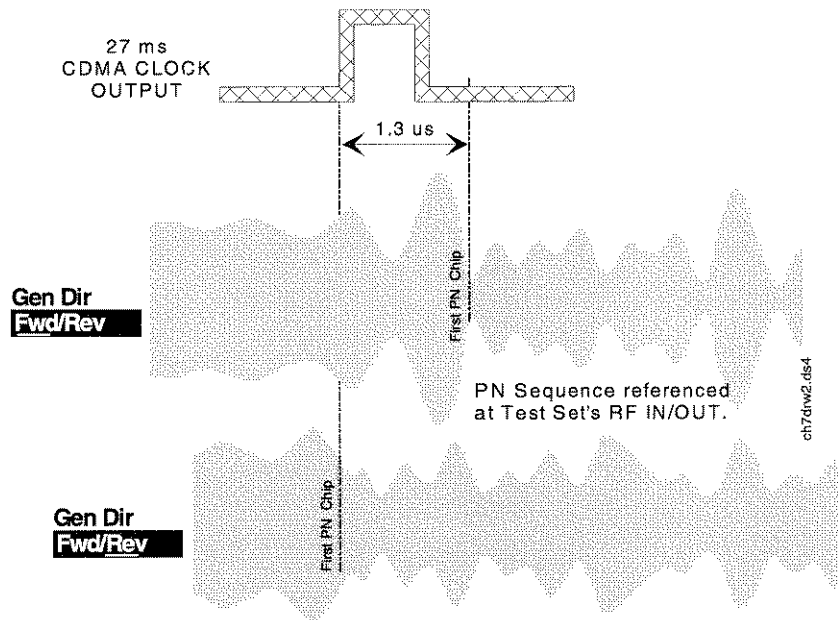

**PN Sequence Delay (Modified)** The following diagram shows the effects of changing the **PN Offset** field to a value other than zero, its default value.

Chapter 7, Theory of Operation  
Timing Diagrams

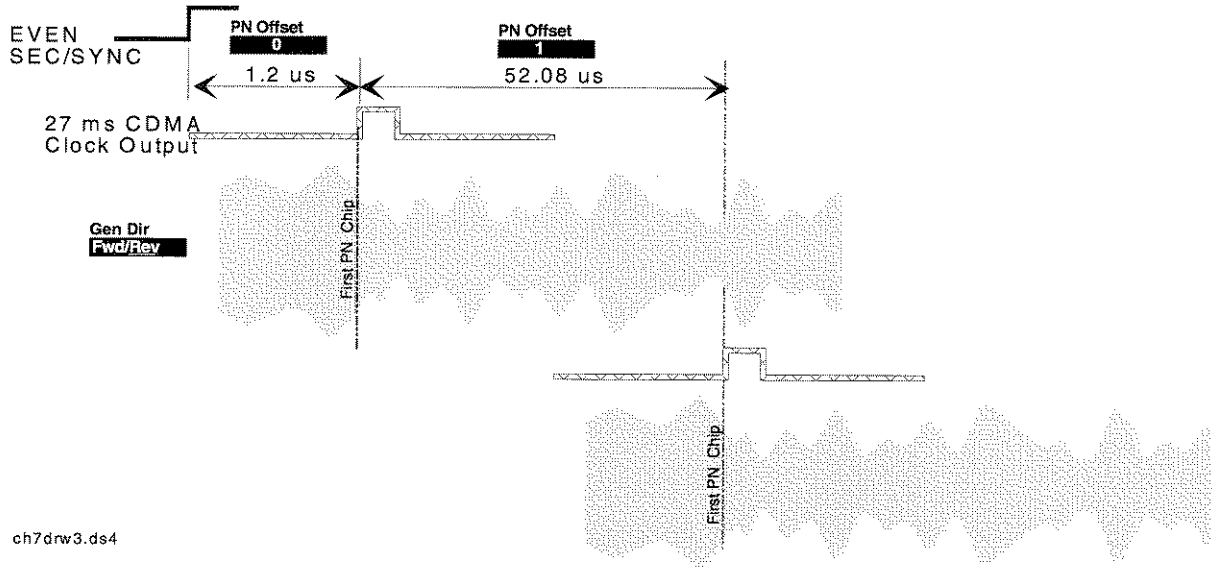

ch7drw3.ds4

## DSP Analyzer Trigger Event Timing

The CDMA Cellular Adapter makes a measurement when the DSP Analyzer receives a trigger event. The following section describes trigger event timing as it relates to the DSP analyzer's measurement process.

### Data Block Acquisition

A trigger event signals the DSP analyzer to acquire a digitized portion of the waveform under test.

A trigger event occurs when:

- The Cellular Adapter is armed,
- a trigger qualifier occurs (unless **None** is selected), and
- the selected trigger occurs

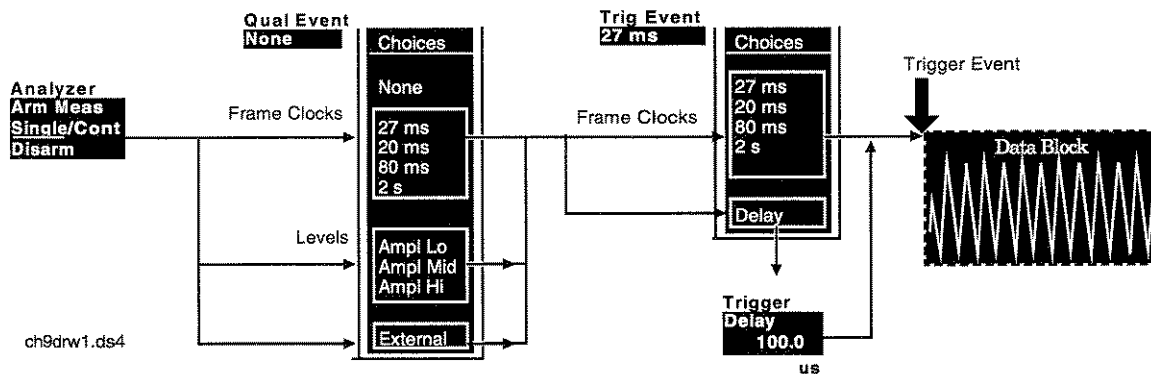

The portion of a digitized waveform acquired by the DSP analyzer when a trigger event occurs is called the Data Block. The length of the data block is selected in the **Meas Intvl** field.

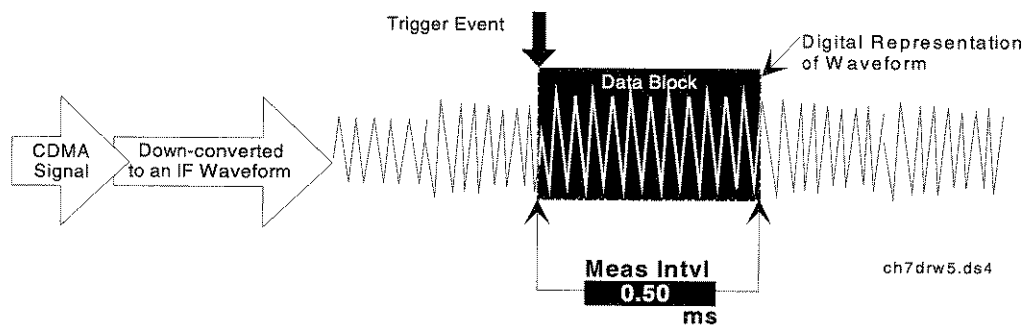

Minimizing the length of the data block provides faster measurements and a slight improvement in the allowable margin for trigger event timing. The trade-off is that minimizing data block's length decreases measurement accuracy, most noticeably in phase and frequency error measurements.

### The Correlation Process

After data block acquisition, the DSP analyzer attempts to correlate the data block with the DSP analyzer's reference signal.

The reference signal is an ideal waveform representation of a CDMA signal. The DSP analyzer searches for a match between the data block and some portion of the reference signal.

The correlation process occurs as follows:

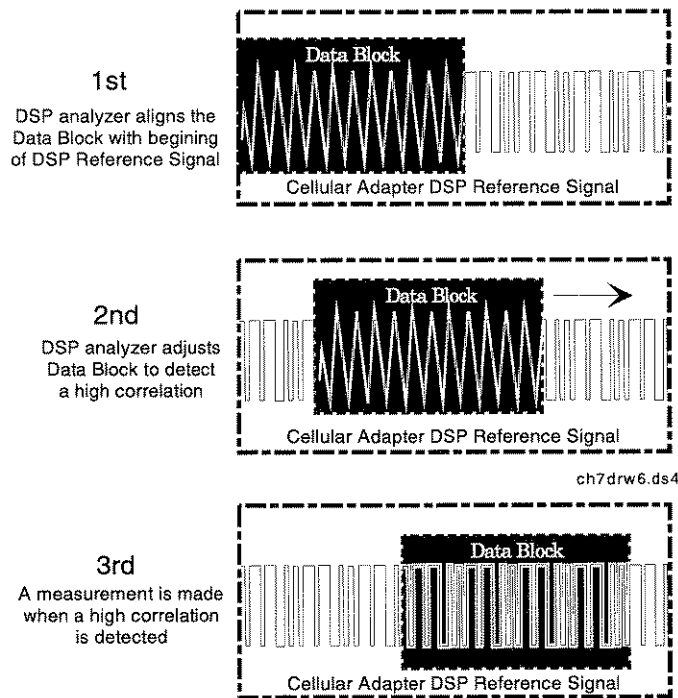

If measurements are displayed, adequate correlation between the data block and some portion of the reference signal was detected.





---

**CDMA Basics**

---

## CDMA and the Problem of Access

The personal communication industry is faced with the problem of an ever increasing number of users sharing the same limited frequency bands. To expand the user base, the industry must find methods to increase capacity without degrading the quality of service.

The current analog cellular system uses a complex system of channelization with 30 kHz channels, commonly called FDMA (Frequency Division Multiple Access). To maximize capacity, FDMA cellular uses directive antennas (cell sectoring) and complex frequency reuse planning.

To further increase system capacity, a digital access method is being implemented called TDMA (Time Division Multiple Access). This system uses the same frequency channelization and reuse as FDMA analog and adds a time sharing element. Each channel is shared in time by three users to effectively triple system capacity.

CDMA stands for Code Division Multiple Access and uses correlative codes to distinguish one user from another. Frequency divisions are still used, but in a much larger bandwidth (1.25 MHz). In CDMA, a single user's channel consists of a specific frequency combined with a unique code.

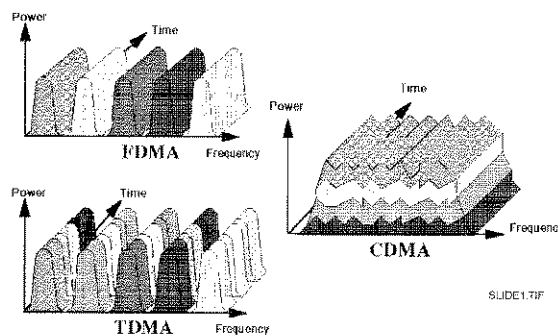

**Figure 16** Cellular Access Methods

CDMA also uses sectored cells to increase capacity. One of the major differences in access is that any CDMA frequency can be used in all sectors of all cells.

The correlative codes allow each user to operate in the presence of substantial interference. An analogy to this is a crowded cocktail party. Many people are talking at the same time, but you are able to understand one person at a time. This is because your brain can sort out the voice characteristics and differentiate them from the other talkers. As the party grows larger, each person has to talk louder, and the size of the talk zone grows smaller. This would be more dramatic if each conversation were in a different language. CDMA is similar, but the recognition is based on the code. The interference is the sum of all other users on the same CDMA frequency, both from within and without the home cell and from delayed versions of these signals. It also includes the usual thermal noise and atmospheric disturbances. Delayed signals caused by multipath are separately received and combined in CDMA. This will be discussed in greater detail later in this presentation.

One of the major capacity gains with CDMA is because of its frequency reuse patterns. The normal reuse pattern for analog and TDMA systems employs only one seventh of the available frequencies in any given cell. This could really be called frequency non-reuse. With CDMA, the same frequencies are used in all cells. When using sectored cells, the same frequencies can be used in all sectors of all cells. This is possible because CDMA is designed to decode the proper signal in the presence of high interference.

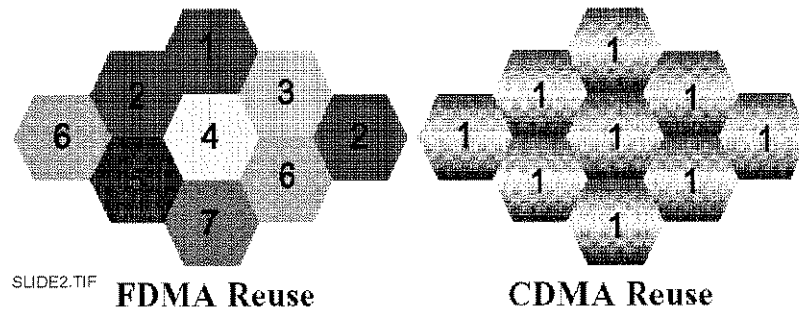
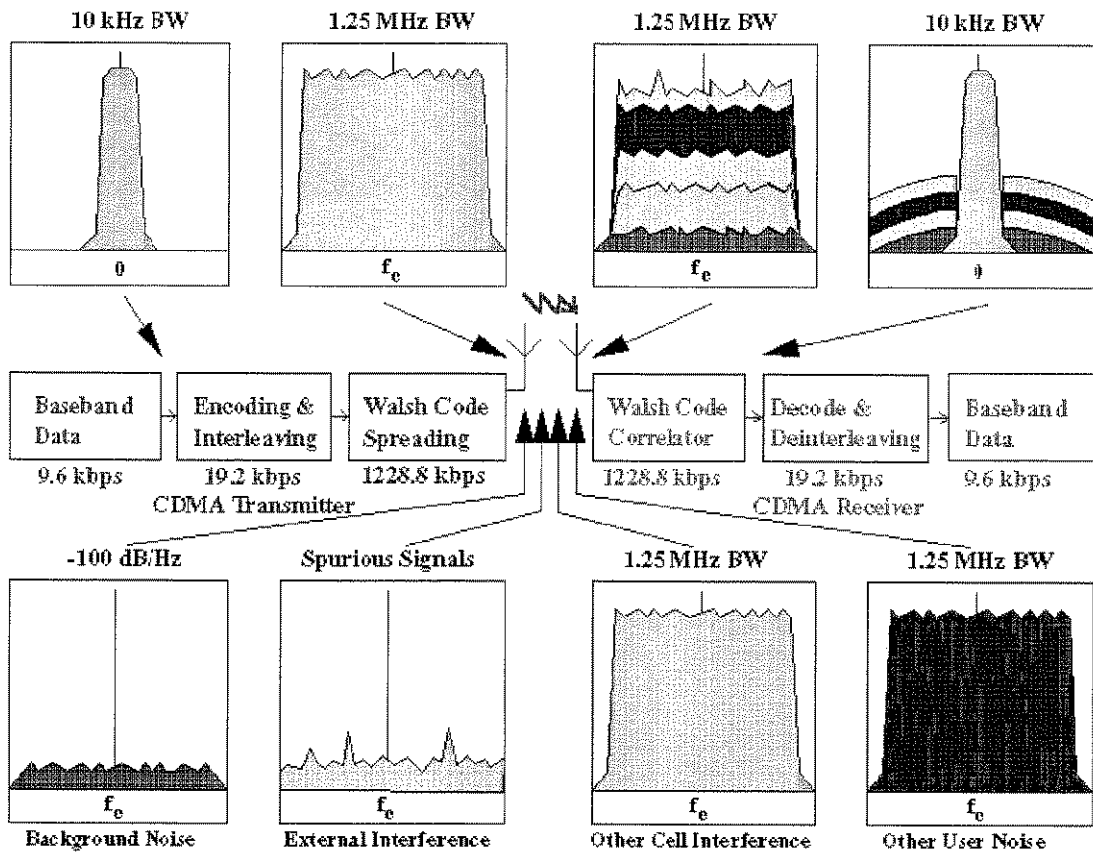

Figure 17

Cellular Frequency Reuse Patterns

## The CDMA Signal



slide3.tif

### Interference Sources

CDMA starts with a narrowband signal, shown here at the full data rate of 9600 bps. This is spread with the use of specialized codes to a bandwidth of 1.23 MHz. When transmitted, a CDMA signal experiences high levels of interference, dominated by the coded signals of other CDMA users. This takes two forms, interference from other users in the same cell and interference from adjacent cells. The total interference also includes background noise and other spurious signals. When the signal is received, the correlator recovers the desired signal and rejects the interference. This is possible because the interference sources are uncorrelated to the desired signal.

---

## CDMA Compared to Analog FM

For most people familiar with FM communication systems, a paradigm shift is needed to properly discuss CDMA.

Here are some differences between CDMA and analog FM:

- Multiple users are on one frequency simultaneously
- A Channel is defined by the correlative code in addition to the frequency.
- The capacity limit is soft. Capacity can be increased with some degradation of the error rate or voice quality.

---

## CDMA and Diversity

An important aspect of CDMA is diversity. CDMA uses three types of diversity:

- Spatial diversity,
- Frequency diversity, and
- Time diversity.

### Spatial Diversity

Spatial diversity takes two forms:

- Two antennas: The base station uses two receive antennas for greater immunity to fading. This is the classic version of spatial diversity.
- Multiple base stations simultaneously talk to the mobile during soft handoff.

During Soft Handoff, contact is made with two base stations simultaneously. The signals from the base to mobile are treated as multipath signals and are coherently combined at the mobile unit. At the base stations, the signals are transmitted via the network to the Mobile Telephone Switching Office (MTSO), where a quality decision is made on a frame-by-frame basis, every 20 ms.

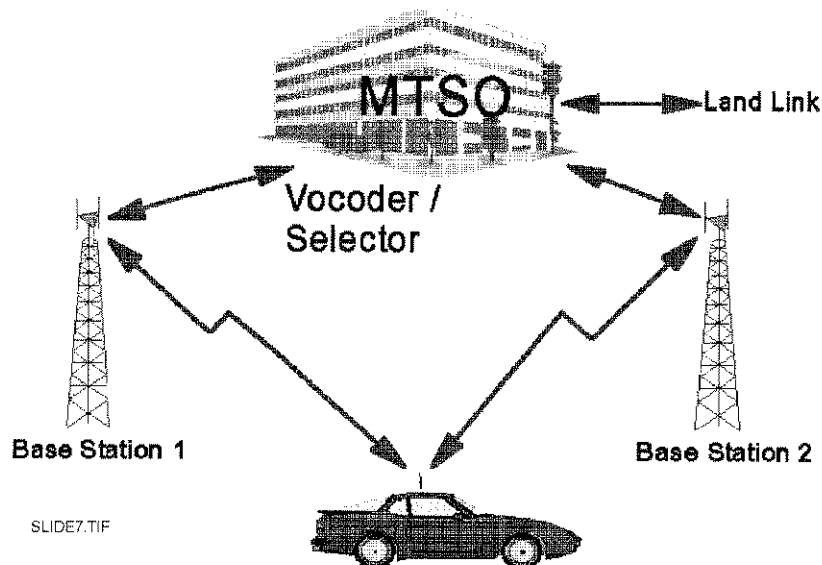

Figure 18

Spatial Diversity During Soft Handoff

## Frequency Diversity

Frequency diversity is inherent in spread spectrum systems. A fade of the signal is less likely than with narrow band systems. Fading is caused by multipath and is a function of the time delays in the alternate paths. In the frequency domain, a fade appears as a notch filter that moves across a band. As the user moves, the frequency of the notch changes. The width of the notch is on the order of one over the difference in arrival time of two signals. For a 1 microsecond delay, the notch will be approximately 1 MHz wide. The TIA CDMA system uses a 1.25 MHz bandwidth, so only those multipaths of time less than 1 microsecond actually cause the signal to experience a deep fade. In many environments, the multipath signals will arrive at the receiver after a much longer delay. This means that only a narrow portion of the signal is lost.

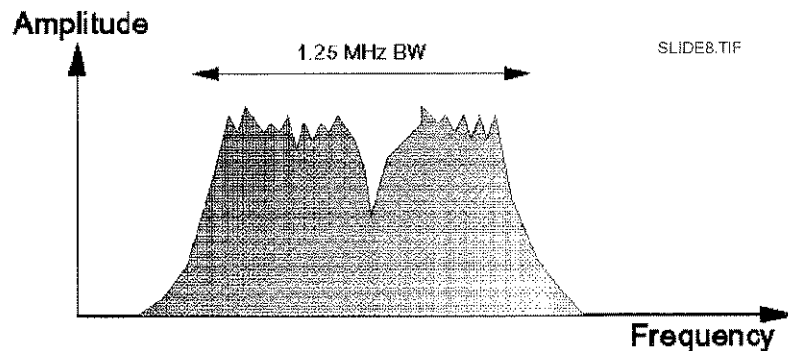

Figure 19

### CDMA Frequency Diversity

In the display shown, the fade is 200 to 300 kHz wide. This results in a power loss to a CDMA signal, but could result in the complete loss of an analog or TDMA signal.

**Time Diversity**

Time diversity is a technique common to most digital transmission systems. Signals are spread in time by use of interleaving. Forward error correction is applied, along with maximal likelihood detection. The particular scheme used for CDMA is convolutional encoding in the transmitter with Viterbi decoding using soft decision points in the receiver.

**Rake Receiver**

CDMA takes advantage of the multipath by using multiple receivers and assigning them to the strongest signals. The mobile receiver uses three receiving elements, and the base station uses four. This multiple correlator system is called a rake receiver. In addition to the separate correlators, searchers are also used to look for alternate multipaths and for neighboring base station signals.

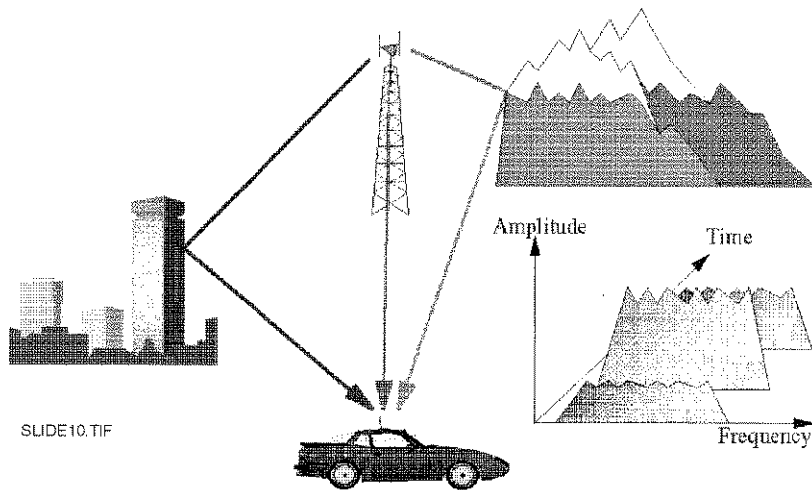

**Figure 20**

**The Rake Receiver**



---

## Power Control

One of the fundamental enabling technologies of CDMA is power control. The power of all mobile units is controlled so that to arrive at the base station with equal power levels. In this way, the interference from one unit to another is held to a minimum.

### Reverse Link Power Control

Two forms of power control are used for the reverse link:

- Open loop power control, and
- Closed loop power control.

#### Open Loop Power Control

Open loop power control is based on the similarity of the loss in the forward path to the loss in the reverse path (forward refers to the base-to-mobile link, while reverse refers to the mobile-to-base link).

Open loop control sets the sum of transmit power and receive power to a constant, nominally  $-73$ , if both powers are in dBm. A reduction in signal level at the receive antenna will result in an increase in signal power from the transmitter. For example, assume that the received power of the composite signal from the base station is  $-85$  dBm. The open loop transmit power setting would be  $+12$  dBm.

#### Closed Loop Power Control

Closed loop power control is used to allow the power from the mobile unit to deviate from the nominal as set by open loop control. This is done with a form of delta modulator. The base station monitors the power received from each mobile station and commands the mobile to either raise power or lower power by a fixed step of 1 dB. This process is repeated 800 times per second, or every 1.25 milliseconds.

Because the power of the mobile is controlled to be no more than is needed to maintain the link at the base station, much less power is typically transmitted from the mobiles than is the case with analog. The analog radio needs to transmit enough power to maintain a link even in the presence of a fade. Most of the time it is transmitting with excess power. The CDMA radio is controlled in real time and is kept at low power. This has the benefit of longer battery life and smaller, lower cost amplifier design. If recent health concerns over cellular phone radiation are founded, CDMA will be preferred.

## CDMA Variable Rate Speech Encoder

CDMA takes advantage of quiet times during speech to raise capacity. A variable rate vocoder is used; the channel is at 9600 bps when the user is talking. When the user pauses, or is listening, the data rate drops to only 1200 bps. 2400 and 4800 bps are also used, though not as often as the other two. The data rate is based on speech activity and a decision as to the appropriate rate is made every 20 ms. Normal telephone speech has approximately a 40% activity factor.

The mobile station lowers its data rate by turning off its transmitter when the vocoder is operating at less than 9600 bps. At 1200 bps, the duty cycle is only one-eighth that of the full data rate. The choice of time for this duty cycling is stochastic, so the power is lowered at all times when averaged over many users. Lowering the transmit power at the mobile reduces the level of interference for all other users.

The base station uses a slightly different scheme. It repeats the same bit patterns as many times as needed to get back to the full rate of 9600 bps. The transmit power for that channel is adjusted to reflect this repetition which allows the interference to be minimized. Repeating the bits at lower power is more effective on the forward link than it could be on the reverse link due to the use of a coherent phase reference called the pilot signal.

---

## Walsh Codes

An important feature of the forward link is the use of Walsh codes. These have the characteristic of being orthogonal to each other and to the logical NOT of each other. Two codes are defined to be orthogonal if they have an exact zero cross product when summed over the full period of the codes. Walsh codes are generated by the expansion shown below:

$$W_1 = 0$$

$$W_2 = \begin{bmatrix} 0 & 0 \\ 0 & 1 \end{bmatrix}$$

$$W_{2^n} = \begin{bmatrix} W_n & W_n \\ W_n & \overline{W_n} \end{bmatrix}$$

The variable, n, in this expansion must always be a power of two. This is seeded with the one by one matrix,  $W_1=0$

### Example

For n=2

$$W_{2^2} = W_4 = \begin{bmatrix} 0 & 0 & 0 & 0 \\ 0 & 1 & 0 & 1 \\ 0 & 0 & 1 & 1 \\ 0 & 1 & 1 & 0 \end{bmatrix}$$

The TIA CDMA system uses a 64 by 64 Walsh matrix (each Walsh code is 64 bits long).

## CDMA Forward Link Physical Layer

Voice data at 9600 bps (full rate) is first passed through a convolutional encoder, which doubles the data rate. It is then interleaved, a process that has no effect on the rate, but does introduce time delays in the final reconstruction of the signal. A long code is XOR'ed with the data, which is a voice privacy function and not needed for channelization. CDMA then applies a 64 bit Walsh code which is uniquely assigned to a base to mobile link to form one channel. This sets a physical limit of 64 channels on the forward link. If the coded voice data is a zero, the Walsh sequence is output; if the data is a one, the logical not of the Walsh code is sent. The Walsh coding yields a data rate increase of 64 times. The data is then split into I and Q channels, and spread with short codes. The final signals are passed through a low pass filter, and eventually sent to an I/Q modulator.

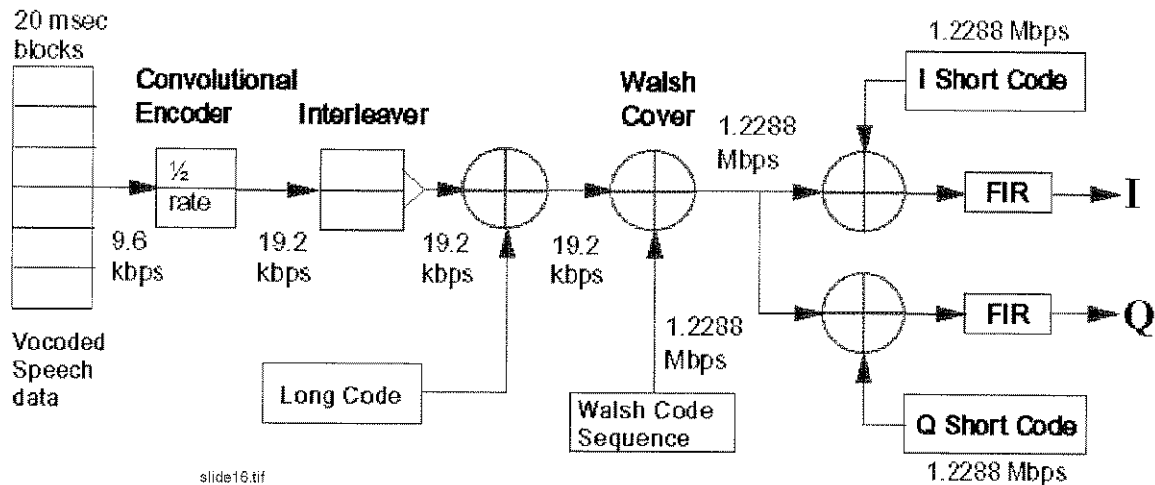

Figure 21 CDMA Forward Link Physical Layer

## Long Code Generation

The Long Code is generated using a 42-bit linear feedback shift register. This is the master clock and is synchronized in all CDMA radios. A specific mask is applied to generate a unique long code.

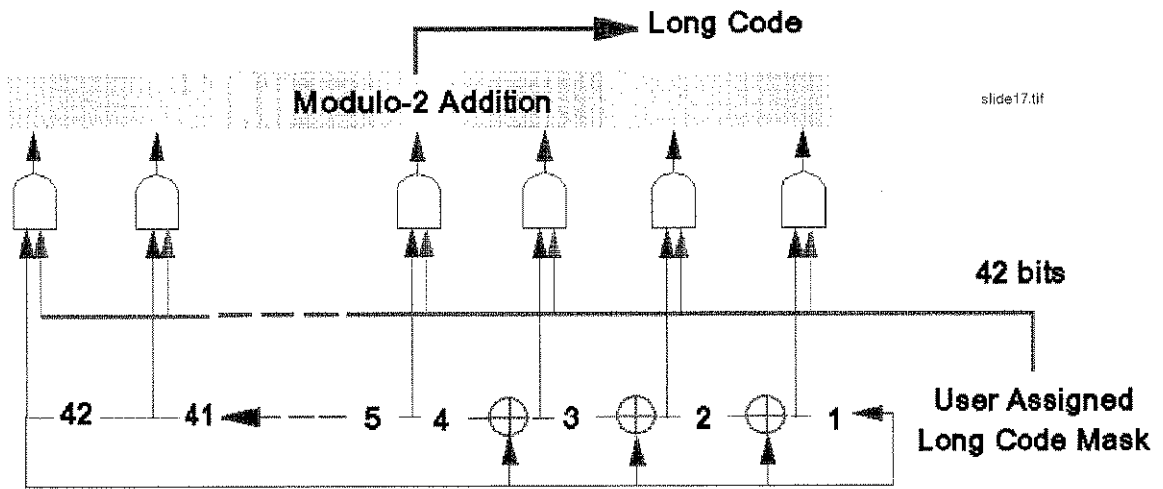
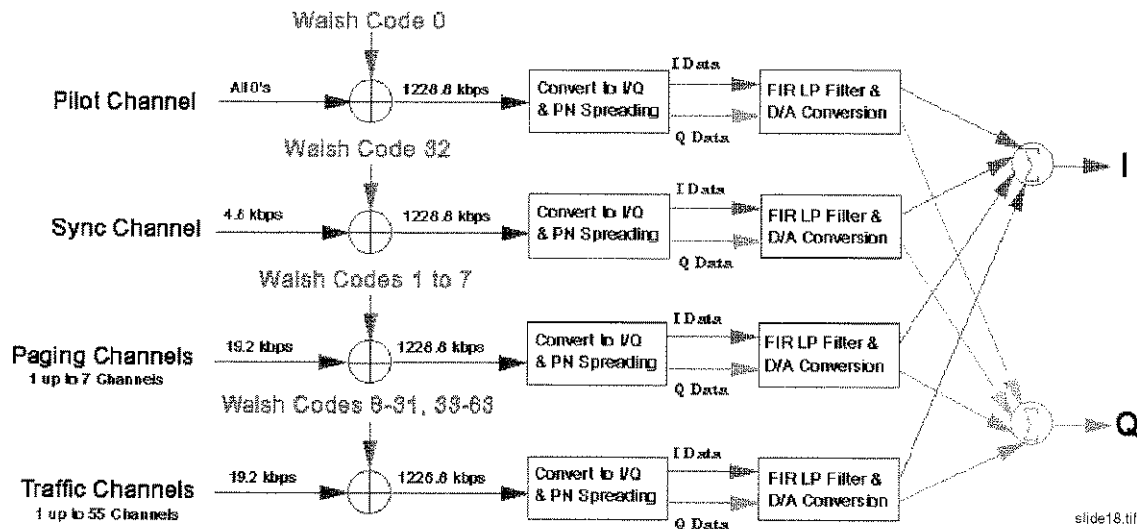

Figure 22 Long Code Generation

## Forward Link Channel Format

The Base Station transmitter signal is the composite of many channels (with a minimum of four). These four channels are the Pilot channel, the Sync channel, the Paging channel, and the Traffic channel.



**Figure 23** CDMA Forward Link Channel Format

### Pilot Channel

The Pilot channel is unmodulated; it consists of only the final spreading sequence (short sequences). The Pilot Channel is used by all mobiles linked to a cell as a coherent phase reference. The other three channels, the Sync channel, the Paging channel, and the Traffic Channel use the same data flow, but different data are sent on these channels.

### Sync Channel

The Sync channel transmits time of day information. This allows the mobile and the base to align clocks which form the basis of the codes that are needed by both to make a link.

- Paging Channel** The Paging channel is the digital control channel for the forward link. Its complement is the access channel which is the reverse link control channel. One base station can have multiple paging channels and access channels if needed.
- Traffic Channel** The Traffic channel is equivalent to the analog voice channel. This is where the actual conversations take place.

## CDMA Reverse Link Physical Layer

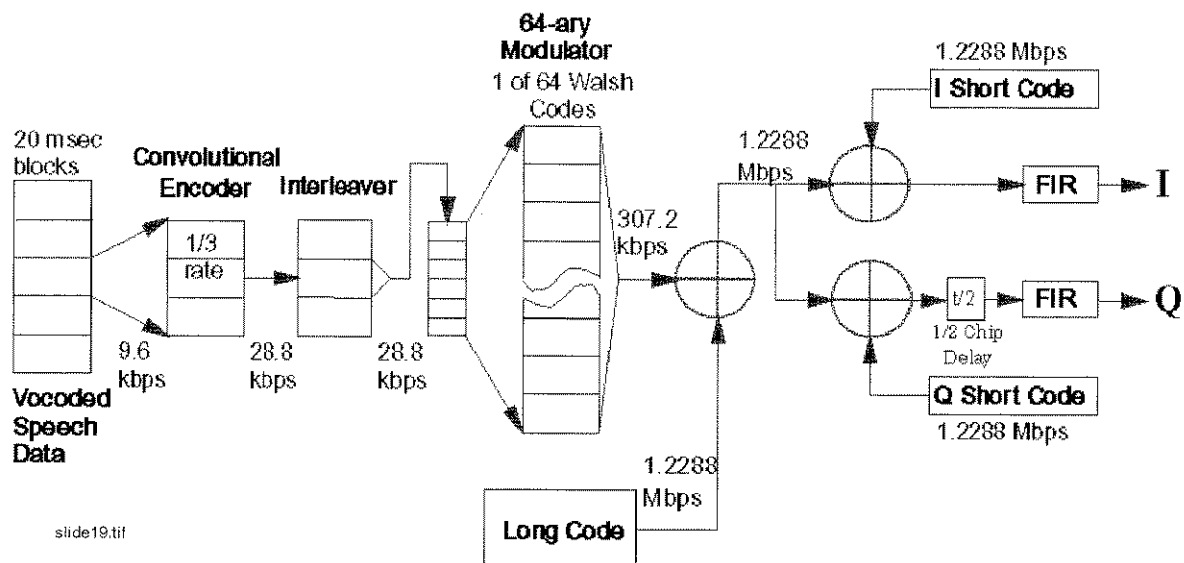

slide19.tif

**Figure 24** CDMA Reverse Link Physical Layer

The CDMA reverse link uses a different coding scheme to transmit data. Unlike the forward link, the reverse link cannot support a pilot channel for synchronous demodulation (since each mobile station would need its own pilot channel). Due to this limitation, the reverse link has less capacity than the forward link. To aid reverse link performance, the 9600 bps voice data uses a one-third rate convolutional coded for more powerful error correction. Then six data bits at a time are taken to point at one of the 64 available Walsh codes. The data, which is at 307.2 kbps, is then XOR'ed with the long code to reach the full 1.2288 Mbps data rate. This unique long code is the channelization for the reverse link.

The modulation is Filtered QPSK in the base station, and Filtered Offset QPSK in the mobile station.



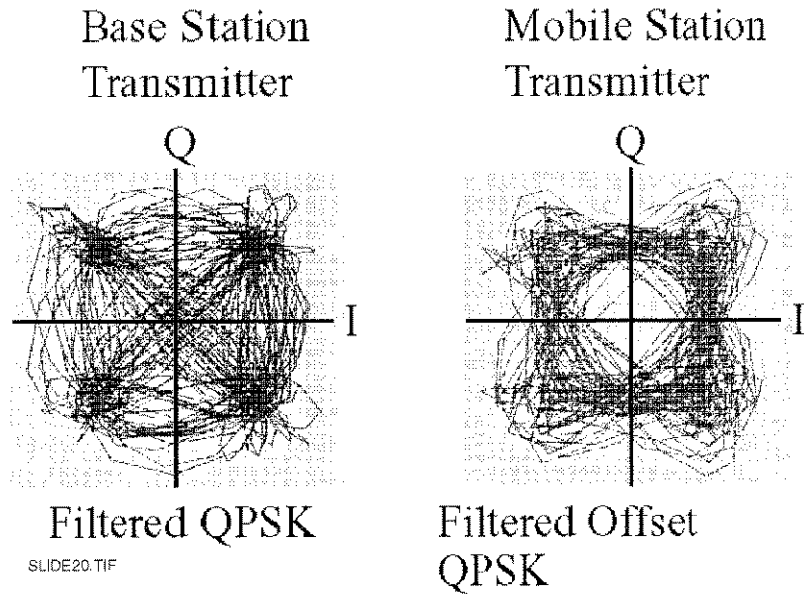

Figure 25

#### CDMA Modulation Formats

Note that the I/Q diagram for the base station signal is for only a single channel (such as the pilot channel). In normal operation, many channels are summed together and transmitted on top of each other by the base station. O-QPSK is used in the mobile stations because it avoids the origin and makes the design of the output amplifier easier. For the base station, since many channels are summed together, using O-QPSK would not always avoid the origin. This is due to random nature of adding many signals together.

---

## CDMA Multiplex Sublayer

Signaling is well structured in CDMA. The full data rate of 9600 bps can be shared between data for the user and signaling data. The channel is effectively a modem that can be used for a variety of services. Current standards exist for service option 1, the vocoder. Service options 2 and 3 are under discussion at the standards committee. These proposed options are for a test mode of data loopback, and data services.

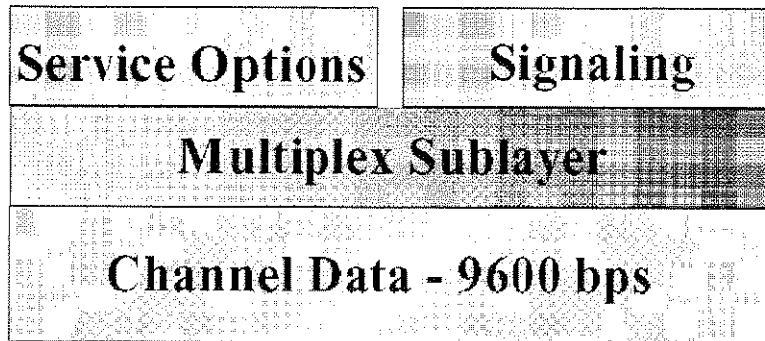

SLIDE21.TIF

Figure 26

CDMA Multiplex Sublayer

---

## CDMA Transmitter Test

The CDMA transmitter is measured for modulation accuracy which is defined as the cross correlation between the actual transmitted power and the ideal. This is important because any uncorrelated power from the transmitter is interference to all users of that frequency. The measurement must first be corrected for frequency error. The mobile must track the frequency of the base within 200 Hz. The modulation accuracy measurement also measures frequency. Power control needs to be checked. Open loop power control is checked by setting the power at the antenna port to a calibrated level and measuring the level of the transmitter. Varying the level of the test source should also vary the mobile station's output power.

## CDMA Call Scenario

*Ten Minutes in the Life of a CDMA Mobile Station* starts with turn-on of the radio and system access. It assumes the car is being driven and that the radio performs an idle state handoff. It covers call initiation, soft handoff and call termination.

### Ten Minutes in the Life of a CDMA Mobile

#### Turn On

**System Access:** When the mobile first turns on, it must find the best base station. This is similar to analog where the phone scans all the control channels and selects the best one. In CDMA, the mobile unit scans for available Pilot signals, which are all on different time offsets. This process is made easier because of the fixed offsets. The timing of any base station is always an exact multiple of 64 system clock cycles ( called chips) offset from any other base station. The mobile selects the strongest pilot tone and establishes a frequency and time reference off this signal. The mobile then demodulates the sync channel which is always on Walsh 32. This channel provides master clock information by sending the state of the 42 bit long code shift register 320 milliseconds in the future. The Sync Channel also contains many other system parameters. The mobile then starts listening to the paging channel, and waits for a Page that is directed to its phone number. The mobile will often register with the base station so that the base station can do location-based paging rather than system wide paging.

### **CDMA Idle State Handoff**

**The mobile has searchers scanning for alternative Pilot tones at all times. If a Pilot tone is found from another base station that is strong enough for a link, the mobile will request a soft handoff. In this case, no call is in process, so it is an idle state handoff. This is an active process that updates the location of the mobile to the system.**

### **CDMA Call Initiation**

The user then decides to make a call. The number is keyed in and the send key is hit. This initiates an Access Probe. The mobile uses the Access Channel and attempts to make contact with the serving base station. As no link is yet established, closed-loop power control is not active. The mobile uses open-loop control to guess an initial level. Multiple tries are allowed with random times between the tries to avoid collisions that can occur on the Access Channel. After each attempt, the mobile listens to the Paging Channel for a response from the base station. The base station responds with an assignment to a traffic channel. This is a Walsh code for the forward link. The traffic channels uses different long codes than the paging channel. The base station initiates the land link, and a conversation can take place.

### **CDMA Soft Handoff**

**During the call, the mobile finds yet another base station with good power. The mobile makes a request from its serving cell to initiate soft handoff with the additional cell. The base station passes this request to the MTSO (Mobile Telephone Switching Office) which contacts the second base station and gets a Walsh assignment. This is sent to the mobile by the first base station. The land link is connected to both base stations. The mobile combines the signals from both base stations by using the two Pilot signals as coherent phase references. At the MTSO, the signals are examined from each base station and the better one is chosen for each 20 milliseconds block. As the signal from the first base station degrades, the mobile will ask that the soft handoff be terminated. At this point the mobile is being power controlled by the second base station (since the first cell probably has a very poor link). The request is passed from the second cell through the MTSO, and the first cell stops transmission and reception of the signal. The mobile is now only on the second cell.**

### **CDMA End of Call**

Finally, the call ends. This can be initiated either from the mobile or the land side. In either case, transmissions are stopped and the land line connection is broken.



---

**Questions and Answers**

---

## CDMA Base Station Transmitter Test

The following pages discuss base station transmitter testing using the Cellular Adapter in conjunction with the HP 8921A CELL SITE TEST SET. Test Set.

The CDMA system standard is defined by EIA/TIA IS-95. Base Station measurement methods and specifications are provided in IS-97.

**The CDMA Signal** A CDMA signal is 1.23 MHz wide. The Test Set transmits a CDMA signal centered around the RF generator frequency setting (see the following figure).

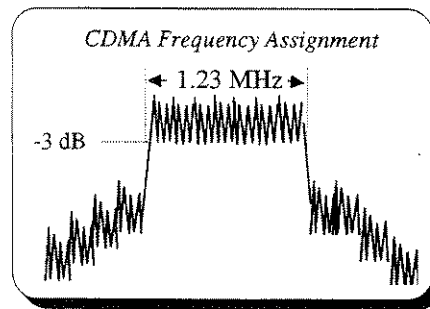

Figure 27

### The CDMA Signal

The Test Set has a spectrum analyzer that will display this signal. Refer to the Test Set's Users Guide for a description of the spectrum analyzer's functions.

CDMA signals are "spread" by combining high-clock-rate binary sequences with low-clock-rate information data. This process creates a much wider bandwidth than a conventional narrowband FM channel would require to transmit at a similar data rate.

The CDMA system makes up for this apparent inefficiency by transmitting multiple subchannels on one CDMA frequency assignment simultaneously. Signal spreading also increases immunity to interference.

On the forward CDMA signal, 64 subchannels (Walsh assignments) are available, each capable of being transmitted simultaneously. Because of coding, CDMA systems have the potential for significant capacity gains over the current FM-based analog cellular systems.



### How do I make measurements?

**Average Power measurements** use a special Envelope Detector circuit in the Test Set that converts the incoming signal to a varying DC voltage. The Cellular Adapter contains a powerful Digital Signal Processing (DSP) Analyzer that looks at this voltage and accurately calculates the Average Power of the signal. This is a broad-band measurement; RF signals of any type are included from 30 MHz to 1 GHz.

**Channel Power measurements** uses special processing to measure the power in a 1.23 MHz bandwidth, rejecting out of channel signals. A quick calibration routine must be run any time the tune frequency is changed.

**Rho, Error Vector Magnitude, and Code Domain measurements** require external timing signals from the base station, and are made when the Cellular Adapter's DSP analyzer has been armed and a qualified trigger is received. A qualified trigger is referred to as a Trigger Event.

When you make a measurement you must ensure that:

- the DSP Analyzer is receiving an acceptable signal level from the base station, and
- that triggering occurs at the right time.

The first consideration, the input level to the DSP analyzer, is controlled by:

- The amplitude of the base station's signal into the Test Set.
- Gain and attenuator settings. The gain into the DSP analyzer will automatically attempt to bring the signal level to the DSP analyzer within acceptable limits. If the level is too high, the Input Attenuators into the Test Set can be changed manually to compensate.

The second consideration, trigger timing, is normally handled by triggering the DSP analyzer with one of the Cellular Adapter's internally-generated CDMA frame clocks. This measurement mode relies on synchronization between the base station's pilot PN sequence and the Test Set's pilot PN sequence.

**What are pilot PN sequences?**

Pilot PN sequences are 32,768 bit binary sequences, sometimes referred to as the “short sequence” spreading code. They are used by the CDMA system for synchronization and to identify each base station by their timing offset in relation to system time.

**When does the pilot PN sequence start?**

The start of the PN Sequence is defined as the first 0-to-1 transition that occurs after 15 consecutive zeros are sent. A Sync Pulse, provided internally at instrument power-on, or externally at the front panel EVEN SECOND/SYNC connector, initiates the process of generating a pilot PN sequence from the Test Set.

The sync pulse also initiates the process of generating the following four CDMA frame clocks:

- 20 millisecond clock
- 27 millisecond clock
- 80 millisecond clock
- 2 second clock

Default timing settings provide 27 ms clock edges synchronized with the start of each pilot PN sequence transmitted at the Test Set’s output.

The DSP analyzer makes measurements on a small portion of the start of a pilot PN sequence. To satisfy triggering requirements, the DSP analyzer must receive a trigger near the beginning of a pilot PN sequence received from the base station.

**How do I cause a trigger event to occur near the beginning of my base station's pilot PN sequence?**

Selecting the 27 ms, 80 ms, or 2 s clock as a trigger will satisfy DSP analyzer trigger timing requirements if the base station under test is synchronized with the pilot PN sequence from the Cellular Adapter. Synchronization is performed using the Even Second clock from the base station.

The following steps describe how to select a trigger mode. For detailed descriptions of trigger and trigger qualifier fields, see **chapter 4, "CDMA Screens Descriptions"**

**1. Select a trigger qualifier.**

The trigger qualifier is a precursor to the trigger event. A trigger qualifier of None can be chosen if a qualifier is not necessary.

**2. Select a trigger.**

A trigger to the DSP analyzer can be external or internal. External triggers are provided through the TRIGGER/QUALIFIER IN front-panel connector.

**3. Select a delay (optional)**

If you want to generate a trigger after a period of time has elapsed relative to CDMA frame clocks, an amplitude level, or an external clock signal, select a trigger delay. The delay period will be relative to the trigger qualifier.

**4. Arm the measurement.**

You can arm the DSP analyzer manually or you can select continuous measurements, which makes arming automatic.

The figure below is a graphic look at trigger and trigger qualifier choices.

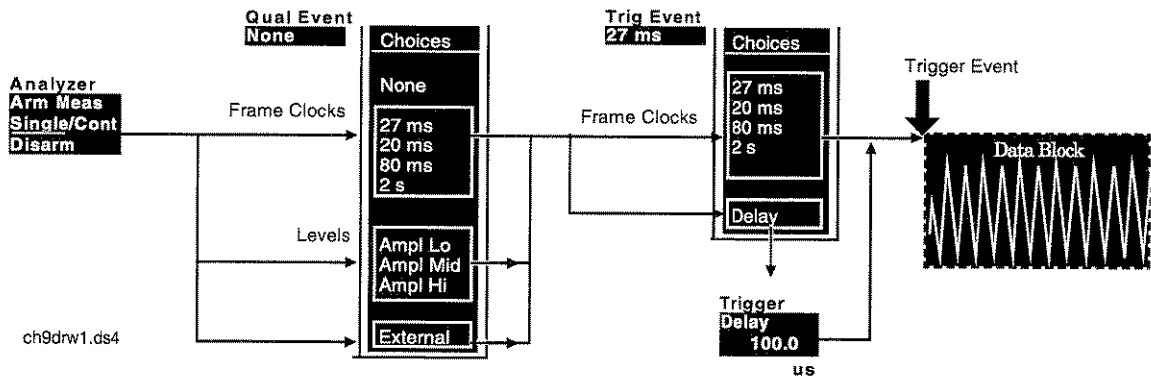

**Figure 28** Trig Event/Qual Event Choices.

**What happens after a trigger event?**

After a trigger event, the DSP analyzer compares a portion of the digitized IF signal from the base station with a replica of the ideal waveform. Calculations are made to determine how well the base station transmitter waveform matches the ideal waveform. Measurement results, along with indications of any errors, are displayed on the Test Set.

A detailed explanation of operation is provided; see **chapter 2, "Making CDMA Measurements"**

---

## CDMA Base Station Receiver Test

The following pages discuss base station receiver testing using the Cellular Adapter and the HP 8920A Cell Site Test Set.

The CDMA system standard is defined by EIA/TIA IS-95. Base Station measurement methods and specifications are provided in IS-97.

### Test Requirements

In order to test a CDMA base station receiver, the Cellular Adapter creates a reverse channel CDMA signal that imitates a mobile station transmitter. This data is always at the full data rate of 9600 bps. The CDMA base station uses a special CRC error detection and correction code to determine if any errors were detected on that signal. The errors are reported as a **Frame Error Rate (FER)** - the percentage of 20 ms frames that contain errors. The measure of quality for the CDMA receiver is the ability to correctly detect and report frame errors at different carrier levels and levels of noise or interference.

The Cellular Adapter cannot read the receiver's FER. Errors must be reported to the base station's local controller and read by the person performing the tests.

**The base station must be disconnected from the receive antennas**, with the Test Set's CDMA Generator connected directly to the receiver inputs.

#### **Do I need to connect any timing signals?**

Yes. The Even Second Clock for each base station in the cell site is derived from GPS time, and is connected to the CDMA generator (using the EVEN SECOND/ SYNC IN port) as a time reference. The **PN Offset** field on the CDMA GENERATOR screen is used to enter the base station's PN Offset so the generator transmits data at the correct time.

### **How do I generate a CDMA signal with data and calibrated noise?**

The RF generator in the Test Set creates an unmodulated carrier that is routed to the Cellular Adapter. The Cellular Adapter contains a section of memory loaded with valid CDMA data, and also contains a calibrated noise generator. The data and noise are summed and sent to an IQ modulator where the carrier from the Test Set is changed into a CDMA signal. All of the controls required for testing receivers are contained on the CDMA GENERATOR screen.

### **Test Descriptions**

**Performance in Additive Noise** tests the ability of the receiver to correctly decode received data in the presence of noise. The Cellular Adapter contains a calibrated noise generator and data source. Data is transmitted at a specific level into the receiver as the noise level is increased. The ratio of data's signal power to the power of the noise that results in a specific Frame Error Rate is the measure of quality. This "signal-to-noise ratio" is referred as  $E_b/N_o$ .

**Receiver Sensitivity** determines the minimum received power, measured at the base station's RF input ports, at which the Reverse Traffic channel Frame Error Rate is maintained at 1%. The CDMA Generator continuously transmits data as the RF amplitude of the signal is reduced until a frame error rate of 1% is reported.

---

## Summary

The Cellular Adapter uses digital signal processing to compare a sample of the base station's signal with an ideal CDMA waveform.

For **Rho and EVM** measurements, the base station must be set up to transmit a pilot channel-only signal and provide the required timing signals to the Cellular Adapter.

**Code Domain Phase, Timing, and Power** measurements can be made on a base station in normal service with the necessary timing signals connected to the Cellular Adapter.

**Average Power and Channel Power** can be measured on a base station in normal service without connecting any timing signals.

For correlated transmitter tests (Rho, EVM, and Code Domain), the measurement setup must ensure that the Cellular Adapter's DSP analyzer is triggered at the right time, and that an acceptable level is presented to the digitizer.

**Receiver tests** require the user to be able to read reported frame errors from the base station while changing the signal characteristics from the CDMA Generator.

For detailed operating instructions, see **chapter 2, "Making CDMA Measurements"** and see **chapter 3, "Troubleshooting Measurement Problems"**

Chapter 9, Questions and Answers  
Summary



---

# 10

---

## Installation

This chapter provides instructions for installing the Cellular Adapter onto the Test Set.

---

## Installation Procedure

### 1. Check your Test Set's Firmware Revision Number.

If your Test Set's firmware is not Revision A. 16.00, you can not use this Cellular Adapter.

## 2. Attach the Cellular Adapter.

- a** Use a T-10 Torx Screwdriver to remove the top front bumpers from the Test Set. Keep the screws for attaching the top instrument.

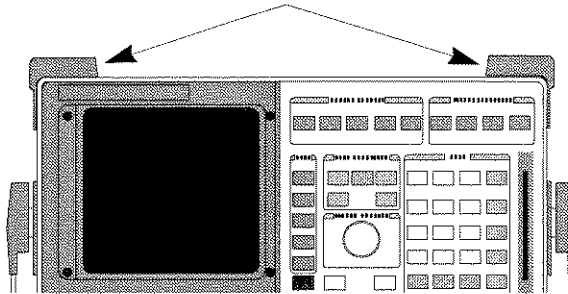

- b** Use a T-10 Torx Screwdriver to remove the three screws along the top of the rear panel. Discard these screws; they are not long enough to reuse.

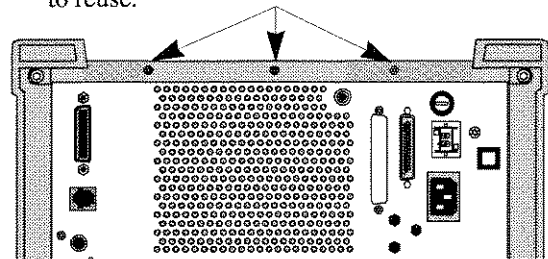

- c** Place the instrument on top of the the Test Set as shown below. Use the screws you removed in step 1 to attach the instruments together at the front. Use the the three new screws (T10, 15 cm) to attach the instruments at the rear.

Attach at the Front

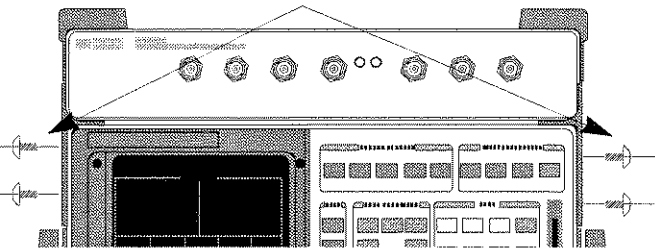

Attach at the Rear

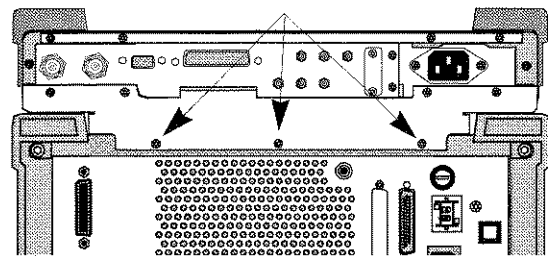

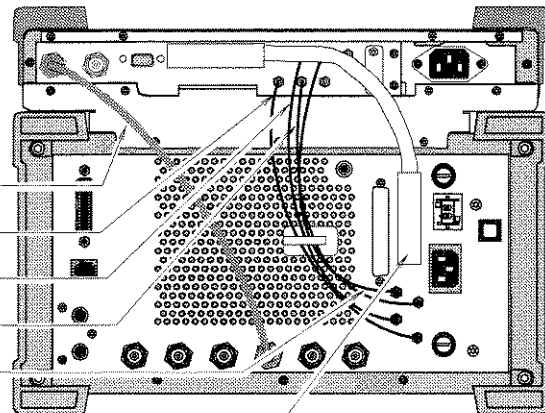

- d** Peel and stick the cable tie, then connect the cables in the following order...

	Cellular Adapter	Cable	Test Set
1	SYNTH REF IN	BNC to BNC	10 MHz OUT
2	CW RF IN	SMC to SMC	CW RF OUT
3	114.3 MHz IF IN	SMC to SMC	114.3 MHz OUT
4	IQ RF OUT	SMC to SMC	IQ RF IN
5	AUX DSP In	SMC to SMC	DET OUT
6	CONTROL I/O	45 pin bus	CONTROL I/O

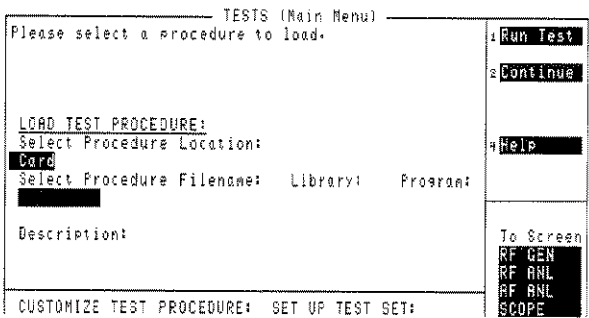
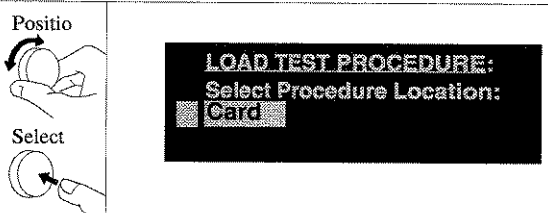
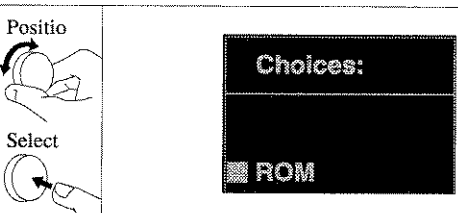
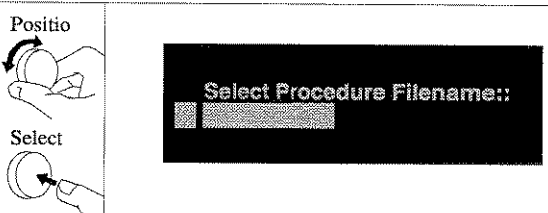
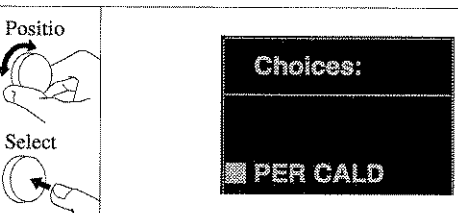
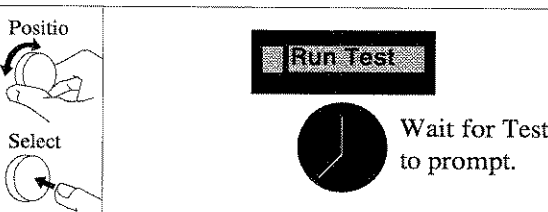

### 3. Attach the Cellular Adapter.

Power-up the instruments and follow the instructions below.

<p><b>a</b> Press the TESTS key to display the TESTS (Main Menu) screen.</p> 	
<p><b>b</b> Position cursor at <b>Select Procedure Location:</b> and select it.</p> 	<p><b>c</b> Position cursor at <b>ROM</b> and select it.</p> 
<p><b>d</b> Position cursor at <b>Select Procedure Filename:</b> and select it.</p> 	<p><b>e</b> Position cursor at <b>PER CALD</b> and select it.</p> 
<p><b>f</b> Position cursor at <b>Run Test</b> and select it.</p>  <p> Wait for Test Set to prompt.</p>	<p><b>g</b> Follow the on-screen instructions to complete &amp; exit the calibration process.</p>

**Access Channel** A reverse CDMA channel used by mobile stations for communicating to the base station. The access channel is used for short signaling message exchanges such as call originations, responses to pages, and registrations. The access channel is a slotted random access channel.

**ADC Analog-to-digital converter** The ADC converts the intermediate frequency (IF) signal from the Test Set into discrete time data for analysis. .

**CDMA Channel** The set of channels transmitted from the base station and the mobile stations on a given frequency. See also forward CDMA channel and reverse CDMA channel.

**CDMA Frequency Assignment** A 1.23 MHz segment of spectrum centered on one of the 30 kHz channels of the existing analog system.

**CDMA Generator** A functional block in the CDMA Cellular Adapter that generates pilot PN sequences with externally or internally applied channel data. A noise generator is also incorporated that is capable of generating calibrated  $E_b/N_0$  signals. .

**Channel** A transmission path between two points. It is usually the smallest subdivision of a particular transmission system by means of which a single type of communication service is provided.

**Code Channel** A subchannel of a forward CDMA channel. A forward CDMA channel contains 64 code channels. Code channel zero is assigned to the pilot channel. Code channels 1 through 7 may be assigned to either the paging channels or the traffic channels. Code channel 32 may be assigned to either a sync channel or a traffic channel. The remaining code channels may be assigned to traffic channels.

**Code Division Multiple Access (CDMA)**  
A technique for spread-spectrum, multiple-access digital communications that creates channels through the use of unique code sequences.

**Code Domain Analyzer** An instrument that measures individual Walsh Channel characteristics in a CDMA channel. The Cellular Adapter can display all 64 Walsh Channels in a received signal and display their power, phase, and timing relationship.

---

## Glossary

**Data Block** The sampled and quantized record of a portion of the IF waveform at the input to the DSP analyzer. The data block's length is determined by the **Interval** field on the CDMA ANALYZER screen.

**dBm/Hz** A measure of power spectral density. dBm/Hz is the power in one Hertz of bandwidth, where power is expressed in units of dBm.

**dB  $\mu$**  A measure of electrical field strength in term of its ratio (in dB) to one microvolt/meter.

**dBW** A measure of power expressed in terms of its ratio (in dB) to one Watt.

**DSP Analyzer** A functional block in the CDMA Cellular Adapter that consists of a high-speed, high-resolution digitizer and a high-performance, floating-point digital signal processor (DSP). The DSP analyzer digitizes the IF (intermediate frequency) signal from the Test Set, and applies digital signal processing algorithms to the resulting discrete time data. Measurement results are sent to the Test Set and displayed on the CDMA ANALYZER screen or CODE DOMAIN ANALYZER screen.

**E<sub>b</sub>** The energy in an information bit.

**E<sub>b</sub>/N<sub>0</sub>** The ratio between the energy of each information bit (E<sub>b</sub>) and the noise spectral density (N<sub>0</sub>). This ratio is usually expressed in dB.

**Even-Second Clock** A clock that occurs every two seconds.

---

## Glossary

**FIR Filter** Finite Impulse Response filter. This is a filter for which the output, in response to an impulse input, totally dies away after a finite time interval. The term is usually used in reference to a digital filter.

**Forward CDMA Channel** A CDMA channel from a base station to mobile stations. The forward CDMA channel contains one or more code channels that are transmitted on a CDMA frequency assignment using a particular pilot PN offset. The code channels are associated with the pilot channel, sync channel, paging channels, and traffic channels. The forward CDMA channel always carries a pilot channel and may carry up to 1 sync channel, up to 7 paging channels, and up to 63 traffic channels, as long as the total number of channels, including the pilot channel, is no greater than 64.

**Forward Link** The link direction from the base station to the mobile station. Also referred to in satellite communications technology as the downlink.

**Forward Traffic Channel** A code channel used to transport primary traffic, secondary traffic, and signaling traffic from the base station to the mobile station.

**Frame** A basic timing interval in the system. For the Access channel, paging channel, and traffic channel, a frame is 20 ms long. For the sync channel, a frame is 26.666...ms long.

**Frame Clocks** A phase-locked loop in the CDMA Cellular Adapter that provides the following CDMA clocks for internal or external (through the rear-panel, 9-pin connector) use:

- 2 second
- 80 millisecond
- 27 millisecond
- 20 millisecond

**Frame Delay Pulse** An internal timing pulse that initiates the Cellular Adapter's CDMA frame clocks. The frame delay pulse occurs after the frame delay timer expires.

**Frame Delay Timer** A timer that determines the interval between the sync pulse and the frame delay pulse.

---

## Glossary

**Long Code** A PN sequence with period  $2^{42}-1$  that is used for scrambling on the forward CDMA channel and spreading on the reverse CDMA channel. The long code uniquely identifies a mobile station or mobile station user (MIN) on both the reverse traffic channel and the forward traffic channel. The long code provides limited privacy and prevents the accidental reception of signals transmitted to another mobile station. The long code also separates multiple Access channels on the same CDMA channel.

**Long Code Mask** A 42-bit binary number that contains system and mobile station dependent values such as the mobile station electronic serial number (ESN), mobile station identification number (MIN), paging channel number, and access channel number. The long code mask creates the unique identities of the long code.

**Mcps** Megachips per second (one million chips per second).

**Modulation Symbol** The output of the data modulator before spreading. On the reverse traffic channel, 64-ary orthogonal modulation is used and six code symbols are associated with one modulation symbol. On the forward traffic channel, each code symbol (when the data rate is 9600 bps) or each repeated code symbol (when the data rate is less than 9600 bps) is one modulation symbol.



---

## Glossary

**Offset Quadrature Phase Shift Keying (OQPSK)** A form of modulation that applies different data sequences to two carriers separated by  $90^\circ$ . The two different data sequences are staggered by half a modulation symbol time. See Also Quadrature Phase Shift Keying.

**Orthogonal Spreading** The application of Walsh functions to baseband CDMA signals. On the forward channel, Walsh functions provide channelization. On the reverse channel, Walsh codes provide a 64-ary modulation symbol set.

**Paging Channel** A code channel on the forward channel used for paging mobile stations. Of the 64 Walsh functions used for channelization on the forward link, one through seven (inclusive) are used for paging channels.

**Pilot Channel** An unmodulated, direct-sequence, spread-spectrum signal transmitted continuously by each CDMA base station. The Pilot channel allows a mobile station to acquire the timing of the forward CDMA channel, provides a phase reference for coherent demodulation, and provides a means for signal strength comparisons between base stations for determining when to hand-off.

**Pilot PN Sequence** A pair of modified maximal length PN sequences with period  $2^{15}$  used to spread the forward CDMA channel and the reverse CDMA channel. Different base stations are identified by different pilot PN sequence offsets.

**Pilot PN Sequence Offset Index** The PN offset in units of 64 PN chips of a pilot, relative to the zero offset pilot PN sequence.

**PN Chip** The time duration of one binary bit in the PN sequence, which is equal to the reciprocal of the frequency at which the PN sequence generator operates. For example, if the PN generator operates at 1.2288 MHz, then a PN chip is 813.802...ns.

**PN Sequence Literally** "pseudo-noise sequence." A periodic binary sequence (with "0" mapped to 1, and "1" mapped to -1). Typically a PN sequence has good autocorrelation which (when normalized) equals 1 for zero shift between the two sequences, and  $-1/N$ , where N is the period, for all other shifts.

**PN Sync Pulse** A signal to the CDMA Generator that initiates pilot PN sequence generation. The start of each pilot PN sequence is synchronized at the Test Set's RF IN/OUT connector to the 27 millisecond frame clock.

---

## Glossary

**Quadrature Phase Shift Keying (QPSK)** A form of modulation that applies different data sequences to two carriers separated by  $90^\circ$ .

**Quadrature Spreading** Frequency spreading performed using pilot PN sequences at a 1.2288 Mcps rate. Also referred to as "short sequence spreading".

**Reference Signal** A replica of the ideal CDMA waveform. The reference signal resides on the Cellular Adapter's DSP analyzer and is correlated with a signal-under-test to determine waveform accuracy and timing offset.

**Reverse CDMA Channel** The CDMA channel from the mobile station to the base station. From the base station's perspective, the reverse CDMA channel is the sum of all mobile station transmissions on a CDMA frequency assignment.

**Reverse Link** The link direction from the mobile station to the base station. Also referred to in satellite communications technology as the uplink.

**Reverse Traffic Channel** A reverse CDMA channel used to transport primary traffic, secondary traffic, and signaling traffic from a single mobile station to one or more base stations.

**Sync Channel** A code channel in the forward CDMA channel that synchronizes the mobile station with the base station.

**Sync Pulse** A pulse that starts both the frame delay timer and the PN sequence delay timers. A sync pulse occurs when:

- the Test Set is powered on, or
- an external even-second clock is received on the CDMA Cellular Adapter's front-panel EVEN SECOND/ SYNC connector.

**System Time** the time reference used by the system. System time is synchronous to Universal Coordinated Time (except for leap seconds) and uses the same time origin as Global Positioning Satellite (GPS) time. All base stations use the same System Time (within a small error). Mobile stations use the same System Time, offset by the propagation delay from the base station to the mobile station. See also Universal Coordinated Time.

---

## Glossary

**Traffic Channel** A communication path between a mobile station and a base station, used primarily for communicating service-option related traffic. The term traffic channel implies a forward traffic channel and reverse traffic channel pair. See also forward traffic channel and reverse traffic channel.

**Traffic Channel Preamble** A sequence of all-zero frames that is sent at the 9600 bps rate by the mobile station on the reverse traffic channel. The traffic channel preamble is sent during initialization of the traffic channel when the mobile station is in the traffic channel initialization substate of the mobile station control on the traffic channel state.

**Trigger Event** Trigger event describes the operating state of the DSP analyzer at the time a qualified trigger causes the DSP analyzer to acquire and begin measuring the digitized IF waveform from the CDMA transmitter-under-test.

**Universal Coordinated Time (UCT)** An internationally agreed-upon time scale that has the same rate as atomic time. UCT is corrected by step adjustments of exactly one second as needed to remain within 0.9 seconds of astronomical time.

**Walsh Chip** The shortest identifiable component of a Walsh function. There are  $2^N$  Walsh chips in one Walsh function where  $N$  is the order of the Walsh function. On the forward CDMA channel, one Walsh chip equals  $1/1.2288$  MHz, or 813.802... ns. On the reverse CDMA channel, one Walsh chip equals  $4/1.2288$  MHz, or 3.255... us.

**Walsh Cover** A coding method that uses Walsh functions to create a set of mutually orthogonal CDMA signals. In the CDMA system, a code channel is formed by a Walsh cover.

**Walsh Function** One of  $2^N$  time-orthogonal binary functions (note that the functions are orthogonal after mapping "0" to 1, and "1" to -1).

**Walsh Symbol** The time necessary to transmit one Walsh function on the reverse CDMA channel.

**Zero Offset Pilot PN Sequence** A pilot PN sequence aligned with System Time such that the first chip on every even-second mark is the "1" following the fifteen consecutive "0"s.

Chapter ,

---

**Symbols**

# of Frames, 116  
data source, 118

**Numerics**

1.288 MHz OUT CHIP CLOCK  
connector, 138  
10 MHz OUT  
connector, 139  
114.3 MHz IF IN, 139  
16 x CHIP CLOCK  
connector, 138  
19.6608 MHz OUT  
connector, 138

**A**

access channel  
definition, 237  
ADC  
definition, 237  
ADC FS, 101  
ADCfs, 130  
Ampl Hi, 96  
trigger qualifier, 111  
Ampl Lo, 96  
trigger qualifier, 111  
Ampl Mid  
trigger qualifier, 111  
Amplitude, 116  
AmplMid, 96  
analog-to-digital converter  
definition, 237  
Analyzer, 126  
Anl Dir, 106  
Anl Special, 107  
Arm Meas, 106  
arming  
code domain analyzer, 126  
attenuator, 108  
AUX DSP IN  
connector, 140  
average power  
measuring, 30  
averaging  
measurements, 129  
Avg Pwr, 101  
AWGN generator, 119

**B****Bypass**

- CW RF Path, 117
- bypass IQ modulator, 117

**C****calibration**

- channel power measurement, 114
- call initiation, 221

**CDMA**

- analyzer control, 106
- capacity, 203, 224
- compared to analog FM, 205
- definition, 237
- description, 202
- frame clocks
  - timing diagram, 194

- generator amplitude, 116
- multiplex sublayer, 218
- signal description, 204, 224
- speech encoder, 210
- timebase, 133

**CDMA channel**

- definition, 237

**CDMA CLOCK OUTPUTS**

- connector, 140

**CDMA frequency assignment**

- definition, 237

**CDMA generator**

- definition, 237

**CDMA TB, 107, 116, 133****CDMA TIMEBASE IN**

- connector, 107, 116, 133, 141

**center frequency, 113, 126****channel**

- definition, 237
- channel number, 113

**channel power**

- measuring, 38

**Channel Pwr, 104****Chn Pwr Cal, 114****closed loop**

- power control, 209

**code channel**

- definition, 237

**code division multiple access, 202**

- definition, 237

**Code Domain Phase, 124****code domain phase**

- measuring, 60

**Code Domain Power, 123****code domain power**

- measuring, 60

**Code Domain Timing, 124****code domain timing**

- measuring, 60

**Cont, 106****CONTROL I/O, 141****Controls**

- code domain analyzer, 125

**correlation**

- data, 199

**CW RF IN, 142****CW RF Path, 117**

**D**

data block, 197  
  definition, 238  
data block acquisition, 197  
data block length, 109, 110, 127  
Data Buff  
  data source, 118  
data buffer, 119  
data buffer source, 118  
DATA IN  
  connector, 142  
Data Source, 118  
Delay, 96  
delay  
  trigger, 113  
DIAGNOSTIC MONITOR OUT  
  connector, 143  
digital signal processor  
  definition, 238  
Disarm, 106  
diversity  
  frequency, 207  
  spatial, 206  
  time, 208  
DSP analyzer  
  definition, 238

**E**

E\_b\_  
  definition, 238  
E\_b\_/N\_0  
  definition, 238  
Eb o, 119  
encoding, 210  
end call, 221  
EQ Filter, 118  
error vector magnitude  
  measuring, 53  
Even Sec In, 108, 119  
EVEN SECOND/SYNC  
  connector, 143  
EVEN SECOND/SYNC IN  
  connector, 108, 119  
EVM, 104  
evm  
  measuring, 53  
Ext  
  data source, 118  
External, 96  
external  
  trigger qualifier, 111  
external clock, 96  
external reference, 112, 117, 121

**F**

fading, 207  
Fast Power, 124  
FDMA  
  description, 202  
finite impulse response filter  
  definition, 239  
FIR filter  
  definition, 239  
forward CDMA channel  
  definition, 239  
forward link, 106  
  channel format, 214  
  definition, 239  
  physical layer, 212  
forward traffic channel  
  definition, 239  
frame  
  definition, 239  
frame clocks  
  definition, 239  
  timing diagram, 194  
frame delay  
  timing diagram, 194  
frequency diversity, 207  
frequency division multiple access, 202  
frequency reuse patterns, 203  
FUSE, 148

---

G

Gain, 108, 130  
Gen Dir, 119  
Gen Mode, 119

H

handoff  
  idle state, 221  
  soft, 221  
HP-IB syntax, 149

I

I Baseband Out  
  connector, 143  
  idle state handoff, 221  
  initiating a call, 221  
Input Attn, 108  
input level, 94  
Input Port, 109  
interference, 204  
Interval, 127  
interval, 197  
IQ  
  CW RF path, 117  
IQ modulator, 117  
IQ RF OUT, 144  
IQ RFOUT  
  connector, 117



---

L

level, 108, 110, 130, 132  
  input, 94  
long code, 213  
  definition, 240  
long code mask  
  definition, 240  
Lvl, 132

M

Magnitude Error, 104  
Main, 126  
MAINS (LINE) Power, 144  
Marker, 131  
Mcps  
  definition, 240  
Meas Intvl, 109  
Measurement, 126  
measurement interval, 109  
measurements  
  how to make, 225  
  types, 101  
modulation  
  OQPSK, 119  
  QPSK, 119  
modulation symbol  
  definition, 240

N

Num Avgs, 129  
number of averages, 129  
number of frames, 116  
  data source, 118

## O

offset  
  PN, 109, 120, 127  
  time, 124, 128, 129  
offset quadrature phase shift keying  
  definition, 241  
open loop  
  power control, 209  
Operation Status Register Group, 158,  
  161, 165  
  accessing registers contained in, 159,  
  163, 167  
  Condition Register bit assignments,  
  159, 162, 166  
OQPSK, 119, 216  
  definition, 241  
OQPSK modulation, 119  
orthogonal  
  definition, 211  
orthogonal spreading  
  definition, 241  
Output Port, 120

## P

paging channel, 215  
  definition, 241  
Phase, 132  
phase  
  code domain, 60  
Phase Error, 104  
phase error, 124  
Phase Scale, 132  
pilot channel, 214  
  definition, 241  
pilot PN sequence, 199  
  definition, 241  
  description, 226  
  timing diagram, 194  
pilot sequence offset index  
  definition, 241  
PN chip  
  definition, 241  
PN Offset, 109, 120, 127  
PN sequence, 241  
PN sequence delay  
  timing diagram, 194, 195  
power  
  average, 30  
  channel, 38  
  code domain, 60, 123  
  display resolution, 132  
power control, 209  
  closed loop, 209  
  open loop, 209  
  reverse link, 209  
power indicator, 147  
power measurement  
  zero, 110  
programming, 149  
Pwr Gain, 110  
Pwr Intvl, 110  
Pwr Scale, 132  
Pwr Zero, 110

## Q

Q Baseband Out, 145  
  connector, 143  
QPSK, 119, 216  
  definition, 242  
QPSK modulation, 119  
quadrature phase shift keying  
  definition, 242  
quadrature spreading  
  definition, 242  
Qual Event, 111  
Qualifier, 96

## R

rake receiver, 208  
random  
  data source, 118  
receiver test  
  performance in additive noise, 72  
  sensitivity, 82  
REF UNLOCK indicator, 147  
reference  
  frequency, 107  
reference frequency, 133  
reference out-of-lock, 147  
reference signal, 199  
referencefrequency, 116  
Refs, 133  
remote operation, 149  
reverse CDMA channel  
  definition, 242  
reverse link, 106  
  definition, 242  
  physical layer, 216  
  power control, 209  
reverse traffic channel  
  definition, 242  
RF Gen Freq, 120  
RF In/Ant, 126  
RF input, 109, 126  
RF loopback  
  test procedure, 23  
RF output, 120  
Rho, 102  
rho  
  measuring, 53

## S

sensitivity  
  receiver test, 82  
Single, 106  
soft handoff, 206, 221  
spatial diversity, 206  
speech encoder, 210  
Start Frame  
  data source, 118  
Status reporting  
  Operation Status Register Group (see  
  Operation StatusRegister Group),  
  158, 161, 165  
  status registers in Test Set, 156  
  structure overview, 156  
sync channel, 214  
  definition, 242  
sync pulse, 226  
  definition, 242  
syntax diagrams, 149  
Synth Ref, 112, 117, 121, 133  
SYNTH REF IN  
  connector, 133, 145  
SYNTHREF IN  
  connector, 112, 117, 121  
system access, 220  
system time  
  definition, 242

## T

TDMA  
  description, 202  
Test Set  
  status registers, 156  
Threshold, 127  
Time, 132  
time diversity, 208  
time division multiple access, 202  
Time Offset, 128, 129  
Time Scale, 132  
timebase  
  external, 107, 116  
  internal, 107, 116  
timing  
  code domain, 60  
timing diagrams, 194  
traffic channel, 215  
  definition, 243  
traffic channel preamble  
  definition, 243  
transmitter test, 219  
Trig Event, 113  
Trigger, 134  
trigger  
  timing, 198  
trigger delay, 96  
  excessive, 97  
  indication of problems, 97  
trigger event  
  definition, 243  
trigger qualifier, 111  
trigger timing  
  setting, 227  
TRIGGER/QUALIFIER IN  
  connector, 96, 111, 146  
triggering, 96, 111, 113, 134  
troubleshooting, 91  
Tune Freq, 113, 126

---

U

UCT

definition, 243

Universal Coordinated Time

definition, 243

V

vocoder, 210

W

Walsh Chan, 131

Walsh chip

definition, 243

Walsh codes, 211

Walsh cover

definition, 243

Walsh function

definition, 243

Walsh symbol

definition, 243

waveform quality

measuring, 53

---

Z

zero offset pilot  
definition, 243

Zeroes  
data source, 118

zeroing  
power meter, 110

zeroing  
power meter, 110

